

**Best
Available
Copy**

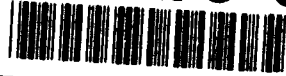

US Army Corps
of Engineers
North Pacific Division

AD-A275 026



Fish Passage Development
and Evaluation Program
1991

Fisheries Handbook

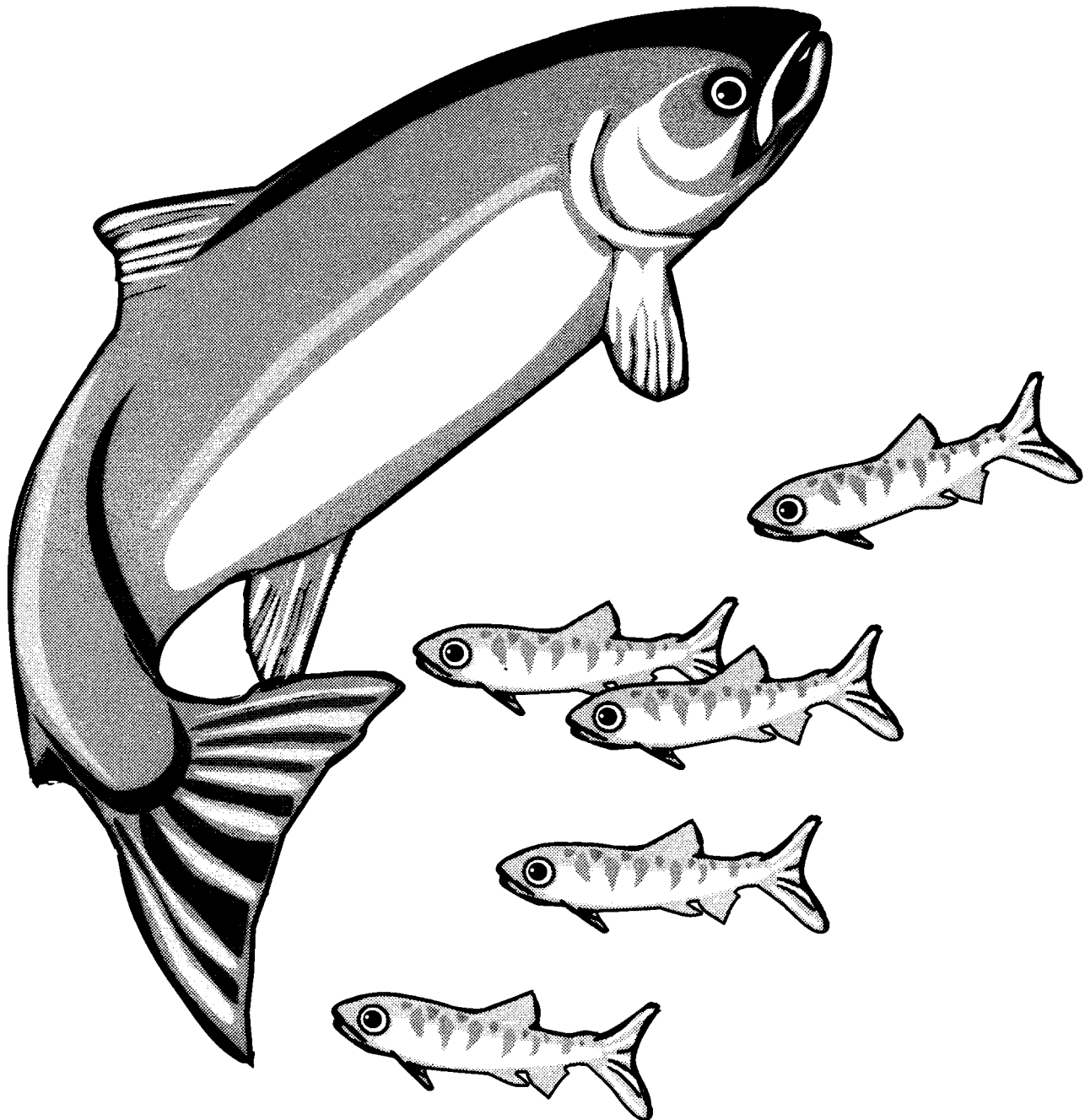

2

1990

Final

Fisheries handbook of engineering requirements and biological criteria.

Bell, Milo C.

DTIC
SELECTED
JAN 13 1994
S B D

U.S. Army Corps of Engineers, North Pacific Division.
Fish Passage Development and Evaluation Program.

Third edition.

Unlimited

DISTRIBUTION STATEMENT A
Approved for public release;
Distribution Unlimited

The Fisheries Handbook provides information on the design of fish passage facilities and their operation. Key elements include biological requirements of fish, biological design criteria, and the design of passage facilities. The biological requirements of fish include discussions of water quality, reactions to toxicants and pollutants, spawning needs, and the effects of fishing pressure. These biological requirements are then used to define biological criteria such as the swimming speeds of juvenile and adult life stages. The biological criteria can then be used by engineers and biologists to design fish passage and mitigation facilities. Passage through turbines, spillways, and conduits are discussed, along with locks, transportation, and mechanical handling. Hatcheries, rearing ponds, diseases, fish pumps, and the use of anesthetics are discussed. Examples of adult fishways and locks are presented. The thirty-five subject areas covered by the handbook include sections on issues and concepts, pertinent tables and graphs of relationships and data, and references.

Fisheries, fish facilities, fish passage, fishways

307

SECURITY CLASSIFICATION
OF REPORT
Unclassified

SECURITY CLASSIFICATION
OF THIS PAGE
Unclassified

SECURITY CLASSIFICATION
OF ABSTRACT
Unclassified

UNCLASSIFIED
UL

FISHERIES HANDBOOK of Engineering Requirements and Biological Criteria

FISH PASSAGE DEVELOPMENT and EVALUATION PROGRAM
Corps of Engineers, North Pacific Division
Portland, Oregon

1990

352-08

94-01440



94 1 12 036

FOREWORD

This is the third edition of the "Fisheries Handbook of Engineering Requirements and Biological Criteria" prepared by Milo C. Bell under contract to the U.S. Army Corps of Engineers, North Pacific Division, first published in 1973.

The first edition received wide acceptance and, though it had been out of print for a number of years, there was still a demand for it. As a result of the continued interest, and since new information had become available, a revised edition was published in 1986, updating a number of chapters. It added information on some east coast species of fish and included a chapter on oxygen.

The continued demand for the Handbook has resulted in its being rewritten for this third edition.

The information contained in this Handbook and the format in which it is presented has not been edited by the Corps of Engineers and reflects the knowledge and expert opinions of the author and contributors.

DTIC QUALITY INSPECTED 8

Accession For	
NTIS GRA&I	<input checked="" type="checkbox"/>
DTIC TAB	<input type="checkbox"/>
Unannounced	<input type="checkbox"/>
Justification	
By	
Distribution/	
Availability Codes	
Dist	Special
A-1	

INTRODUCTION

This handbook is for use by engineers and biologists employed in design problems on fish facilities and in the operation of existing facilities.

When examining criteria for these works it must be recognized that there are local requirements that may dictate approaches and limits. It further must be recognized that individual states and agencies of the Federal government have adopted standards that may be in variance with each other.

It is not the purpose of this handbook to dictate policy, and the user cannot assume that the criteria set forth are acceptable at specific locations. The Handbook does set forth limits that may be used in design for estimating facility sizes, water requirements, general costs, and operating procedures. The user of this Handbook must recognize that state and federal agencies, such as various control authorities, water use granting authorities, and the Courts, impose regulations that may dictate, expand or limit the standards set by fishery agencies. Examination of these standards should be made by any investigator.

As the body of information in scientific management of fisheries is less than 70 years old, it must follow that criteria set forth in this book may be substantially altered by findings in current research projects. In many cases, basic biological factors are not fully understood, making the criteria empirical in nature and subject to the necessary treatment of all such data.

The criteria chosen for this handbook are the result of examinations of both published and unpublished works of various agencies and individuals and thus may be in variance. In developing the details, workable limits have been set forth but cannot be considered as absolute under the state-of-the-art.

ABOUT THE AUTHOR

Milo C. Bell has spent over 40 years in the field of fisheries as a researcher, designer, teacher and consultant. He holds the rank of Professor Emeritus at the University of Washington School of Fisheries. He is a member of the National Academy of Engineering, a Fellow of the American Institute of Fisheries Research Biologists, and a Registered Professional Engineer. He received a Bachelor of Science degree in Mechanical Engineering from the University of Washington in 1930.

He was Chief Engineer of the Washington Department of Fisheries and the International Pacific Salmon Fisheries Commission. He was one of the principal designers of the fishway system at Bonneville Dam, and he has assisted the Corps of Engineers as a consultant on fish passage facility design at other dams on the Columbia River and in Puget Sound.

He has served as a consultant in all of the Pacific Coast states and in the Province of British Columbia, and for a number of major power companies and agencies on both coasts and in the Midwestern part of the United States. He has been responsible for the design of more than 60 fish facilities in the form of hatcheries, fishways and artificial spawning beds, and for more than 50 fish screens.

Other fishery activities have concerned the development of methods of measuring spawning areas, the development of equipment for testing behavioral patterns of young and adult fish, the analysis of data on fish passage through turbines and spillways, and the development of models for use in the design of fish facilities.

CONTRIBUTORS

The contributors to the first and second editions were: **Ernestine Brown** (library research and annotations of more than 2,500 publications, of which selected references were listed in the Handbook); **Kenneth J. Bruya** (review of materials used in chapters, "Useful Factors in Life History of Most Common Species," "Swimming Speeds," "Food Producing Areas," "Hatcheries," "Rearing Ponds," and "Oxygen"); **Ann Downs** (illustrations and tables); **Don M. Fagot** (review of materials used in chapters "Food Producing Areas," and "Temperature - Effects on Fish"); **Christopher K. Mitchell** (review of materials used in chapters "Silt and Turbidity," "Swimming Speeds," and "Artificial Spawning Channels"); **Zell E. Parkhurst** (research and preparation of materials used in various chapters in the Handbook); **Russell J. Porter** (assisted in the preparation of various chapters and acted as an aide to the author); and **Marjorie Stevens** (edited, directed and coordinated the preparation of text and exhibits).

The contributors to the third edition were: **Ronald E. Nece, Sc.D., P.E.**, Professor of Civil Engineering, University of Washington, who supplied hydraulic geometry information for use in the chapter, "Spawning Criteria." He developed a method of approach to supply missing data in reported uses on turbines and analyzed a number of Francis, Kaplan and bulb turbines as to strike and pressure. He also supplied the hydraulic geometry information used in the chapters, "Culverts" and "Channel Changes."

Jay S. Kidder, B.S. (Fisheries) and B.S. (Civil Engineering), P.E., acted as assistant to the author. He developed the material for pen rearing in the chapter on "Hatcheries" and computer approaches for numerous graphic presentations throughout the book. He reviewed and contributed to various chapters.

Ann Downs, the book designer, typographer and production artist, also redesigned several charts and diagrams.

Marjorie Stevens edited, directed and coordinated the preparation of text and exhibits.

ACKNOWLEDGEMENTS

I wish to acknowledge the assistance of **John Ferguson** of the Corps of Engineers, Portland District, for his suggestions for subject inclusion in the third edition.

Illustrations, photographs and tables have been used from publications of the **Corps of Engineers, Oregon Fish Commission, Oregon Game Commission** and **Washington Department of Fisheries**. These are credited in the chapters and are here acknowledged.

The information contained in the first edition was from the work of many investigators, generally in public agencies. In the preparation of the first edition, comments and suggestions were received from many sources:

Corps of Engineers (Clyde Archibald, Ivan Donaldson, Edward M. Mains, Philbin F. Moon, Raymond C. Oligher);
Oregon Fish Commission (Ernest R. Jeffries, Edward K. Newbauer);
Oregon Game Commission (Chris Jensen, Reino Koski, William Pitney);
Washington Department of Fisheries (Russell Webb);
Washington Department of Game (Clifford Millenbach).

CONTENTS

Note: The page numbers used in this third edition is based on the chapter number and the number of pages within that chapter. For example, Chapter 2, page 1 becomes 2.1 and so forth. This table of contents shows the number of pages for each chapter. For example: 2.1 - 2.4 (4 pages of text).

Chapter 1
MISCELLANEOUS INFORMATION
(Pages 1.1 - 1.12)

Chapter 2
DEFINITIONS of Common Terms in Use
(Pages 2.1 - 1.4)

Chapter 3
LEGAL
(Pages 3.1 - 3.2)

Chapter 4
SCIENTIFIC and COMMON NAMES of Some of the More Abundant Fish Species
(Pages 4.1 - 4.12)

Chapter 5
USEFUL FACTORS in LIFE HISTORY of Most Common Species
(Pages 5.1 - 5.32)

Chapter 6
SWIMMING SPEEDS of Adult and Juvenile Fish
(Pages 6.1 - 6.9)

Chapter 7
SPAWNING CRITERIA
(Pages 7.1 - 7.14)

Chapter 8
FOOD PRODUCING AREAS
(Pages 8.1 - 8.20)

Chapter 9
EFFECTS of FISHING PRESSURE
(Page 9.1)

Chapter 10
WATER QUALITY
(Pages 10.1 - 10.3)

Chapter 11
TEMPERATURE - Effects on Fish
(Pages 11.1 - 11.10)

Chapter 12
SILT and TURBIDITY
(Pages 12.1 - 12.8)

CONTENTS

(Continued)

Chapter 13
TOXICITIES of Elements and Compounds
(Pages 13.1 - 13.9)

Chapter 14
METALS
(Pages 14.1 - 14.2)

Chapter 15
PLASTICS
(Page 15.1)

Chapter 16
PESTICIDES and HERBICIDES
(Pages 16.1 - 16.4)

Chapter 17
FISH TOXICANTS
(Pages 17.1 - 17.5)

Chapter 18
AVOIDANCE
(Pages 18.1 - 18.2)

Chapter 19
HATCHERIES
(Pages 19.1 - 19.17)

Chapter 20
REARING PONDS
(Pages 20.1 - 20.8)

Chapter 21
FISH DISEASES - Types, Causes and Remedies
(Pages 21.1 - 21.14)

Chapter 22
USE of ANESTHETICS and TRANQUILIZER DRUGS in Fisheries Work
(Pages 22.1 - 22.7)

Chapter 23
FISH PUMPS
(Page 23.1)

Chapter 24
MOVEMENT of DOWNSTREAM MIGRANTS
(Pages 24.1 - 24.4)

CONTENTS

(Continued)

Chapter 25
PASSAGE of FISH Through Turbines, Spillways and Conduits
(Pages 25.1 - 25.5)

Chapter 26
ARTIFICIAL GUIDANCE of FISH
(Pages 26.1 - 26.16)

Chapter 27
ARTIFICIAL SPAWNING CHANNELS
(Pages 27.1 - 27.4)

Chapter 28
PREDATION
(Pages 28.1 - 28.2)

Chapter 29
RECOVERY GEAR
(Pages 29.1 - 29.5)

Chapter 30
TRANSPORTATION - Mechanical Hauling of Fish
(Pages 30.1 - 30.6)

Chapter 31
CULVERTS
(Pages 31.1 - 31.3)

Chapter 32
CHANNEL CHANGES
(Pages 32.1 - 32.5)

Chapter 33
LOCKS and MECHANICAL HANDLING
(Pages 33.1 - 33.4)

Chapter 34
FISHWAY STRUCTURES at Dams and Natural Obstructions
(Pages 34.1 - 34.41)

Chapter 35
OXYGEN
(Pages 35.1 - 35.7)

INDEX
(Pages 1 - 8)

Chapter 1

Miscellaneous Information

Conversion Factors (English to Metric and Metric to English)

Other Equivalents (English and Metric)

Terminology and Equivalents

Definitions

Miscellaneous Information

Miscellaneous Definitions

Comparison of 1 Cubic Foot and 1 Cubic Meter (Ratio 1:35.3357)

Basic Formulas (English System)

Some Pipe and Circle Areas For Use in Hydraulics

Beaufort Scale of Wind Velocity

Wind Chill Chart (Actual Thermometer Reading F.)

Relative Humidity Tables
Wet-bulb Temperature in F.
Air Temperature in F.

Lethal Distance from Explosion (Ft.)

Nomogram Showing the Solubility of Oxygen in Water

Nomogram for Determining N_2 (with A_2) at ATM Pressure and Different Temperatures

Nomogram for Determining O_2 Saturation at Different Temperatures and Altitudes (Mortimer)

MISCELLANEOUS INFORMATION

Conversion Factors (English to Metric and Metric to English)

	English Unit →	Multiplier →	Metric Unit →	Multiplier →	English Unit
Length	inches	25.4	millimeters	0.0394	inches
	inches	2.54	centimeters	0.3937	inches
	feet	0.3048	meters	3.2808	feet
	miles	1.6093	kilometers	0.6214	miles
Area	square inches	645.16	square millimeters	0.00155	square inches
	square feet	0.0929	square meters	10.7643	square feet
	acres	0.4047	hectares	2.4710	acres
	square miles	2.590	square kilometers	0.3861	square miles
Volume	cubic inches	0.0164	liters	61.02	cubic inches
	cubic inches	16.387	cubic centimeters	0.0610	cubic inches
	cubic feet	0.0283	cubic meters	35.3357	cubic feet
	cubic yards	0.7646	cubic meters	0.3079	cubic yards
	gallons	3.7854	liters	0.2642	gallons
	acre-foot	1233.5	cubic meters	0.0008	acre-foot
	thousands of acre-feet	1.2335	cubic hectometers	0.8107	thousands of acre-feet
	millions of acre-feet	1.2335	cubic kilometers	0.8107	millions of acre-feet
Flow	cubic feet/second	0.0283	cubic meters/second	35.3357	cubic feet/second
	gallons/minute	0.0631	liters/second	15.85	gallons/minute
	gallons/minute	3.7854	liters/minute	0.2642	gallons/day
	gallons/minute	6.309×10^{-5}	cubic meters/second	15850.372	gallons/minute
	million gallons/day	.0438	cubic meters/second	22.8311	million gallons/day
Mass (Weight)	pounds	0.4536	kilograms	2.2046	pounds
	ounces	28.3495	grams	0.0353	ounces
	grains	0.0648	grams	15.432	grains
Velocity	feet/second	0.3048	meters/second	3.2808	feet/second
Power	horsepower	0.746	kilowatts	1.3405	horsepower
	British thermal unit	2.93×10^{-4}	kilowatt hour	3412.0	British thermal unit
Pressure	pounds/square inch	6.8948	kilopascals	0.1450	pounds/square inch
	feet head of water	2.989	kilopascals	0.3346	feet head of water
	pounds/square inch	51/7112	millimeters Hg	0.0193	pounds/square inch
Capacity	gallons/minute/foot drawdown	12.419	liters/minute/meter drawdown	0.0805	gallons/minute/foot drawdown
Concentration PPM	parts/million	1.0	milligrams/liter	1.0	parts/million
	grain/gallon	17.1233	milligrams/liter	0.0584	grain/gallon
Temperature	° Fahrenheit	(°F-32)/1.8	° Celsius	(°C x 1.8)+32	° F

MISCELLANEOUS INFORMATION

Other Equivalents (English and Metric)

7000 grains = 1 pound
1 grain/gallon = 17.12 parts/million
1 grain/gallon = 142.9 lbs/million gallons
1 pound/million gallons = 0.1199 parts/million
1 part/million = 0.0584 grains/gallon
1 part/million = 8.34 pounds/million gallons
1 gallon = 231 cubic inches
1 cubic foot = 7.48 gallons
1 cubic foot of water = 62.416 pounds
1 gallon of water = 8.34 pounds
1 cubic foot/second = 646,317 gallons/24 hrs (448.8 gpm)
1 million gallons/24 hrs = 1.547 cubic feet/second
1 million gallons/24 hrs = 694 gallons/minute
1 acre = 43,560 square feet
1 knot = 1.1508 miles per hr

1 calorie = 0.0003968 BTU
1 calorie = 4.19 joules
1 joule = 0.2388 calories
1 dyne = 1.02 Kg (or Kilogram)
1 dyne = 2.248 lb.

At Atmospheric Pressure

BTU (above 32 F.)
required to produce vapor = +1150.4 at ATM

BTU (below 32 F.)
required to produce ice = -144 at ATM

Absolute temperature in F. = -459.6880
Absolute temperature in C. = -273.15
R° = Absolute + measured temperature in F. or C.

MISCELLANEOUS INFORMATION

Terminology and Equivalents

Legal measurement of water = one cubic foot per second (cfs, second feet or cusecs) or fraction of cfs

One second foot = 7.48 U.S. gallons per second
= 448.8 U.S. gallons per minute
= 646,317 U.S. gallons per day

One second foot for a day = 86,400 cubic feet
or 1.983 acre feet

One acre foot is a surface acre covered one foot in depth

Runoff from watersheds is measured in acre feet or in inches per square mile

Acre = 43,560 sq. ft

Square mile = 640 acres

Atmospheric pressure at sea level = 14.697 lb./sq. inch or 33.901 ft. of fresh water

1 atm pr = 29.92 inches mercury
760 mm mercury
1013 millibars

Slope in channels is measured by fall per unit of length, as feet per mile

Velocity is measured in feet per second = 1.4667 feet per second = 1 mile per hour

$F = (M)(g)$ Force = Mass X gravity

$M = W/g$ Mass = Weight/gravity

Density (specific gravity) is the ratio of the mass of a body to the mass of an equal volume of fresh water at a standard temperature. (The temperature used by physicists is 39°F. or 4° C.)

Maximum density of water is at 39.3 F. or about 4 C.

Fresh water pressure equals .43344 lbs. per sq. in. per ft. of depth

Water weighs 62.424 lbs./cu. ft. at maximum density

Water weighs 62.416 lbs./cu. ft. at 32° F.

Water weighs 62.419 lbs./cu. ft. at 45° F.

Water weighs 62.390 lbs./cu. ft. at 55° F.

Power:

hp = 550 foot pounds per second
= 33,000 foot pounds per minute

1 K.W. = 1.3405 hp

1 hp = 746 watts

1 KWH = 3412 BTU

1 kw (English) = 3412 BTU/hr

1 hp (English) = 550 ft./lb.sec
= 745.7 watts
= 2544.3 BTU/hr

1 hp (English) = 0.9863 hp (metric)

1 hp (metric) = 1.0139 (English)

Components - dry air in percent:

Nitrogen 78.09

Oxygen 20.95

Argon 00.93

Carbon Dioxide 00.03

Balance - Hydrogen, Xenon, Ozone and Radium

Speed of sound (water) - 4793 fps

Speed of sound (air) - 1126 fps

Speed of light (air) - 186,330 miles/sec

MISCELLANEOUS INFORMATION

Definitions

- Q** Discharge in cubic feet per second (cfs or second feet) or any of the other units expressing volumes per unit of time defined in previous sections
- A** Cross-sectional area in square feet or other convenient unit
- \bar{V} Average of mean velocity in feet per second or other convenient unit
- V** Velocity at a point in feet per second or other convenient unit
- g** Acceleration of gravity (usually considered to be 32.2 ft/sec/sec) at sea level
- H** Head in feet acting on a weir, at a dam, or over an orifice $V^2/2g$
- h** Head in feet acting on an orifice, and also velocity head $V^2/2g$
- C** Coefficient of discharge (dimensionless) for an orifice or weir, or coefficient of roughness for an open channel or pipe
- R** Hydraulic radius of a stream in feet, which is equal to a cross sectional area (A) divided by the wetted perimeter of the cross-section (P). A/P in sq ft and feet
- S** Gradient or slope of open channel expressed as drop in feet divided by the length of the channel in feet over which the drop takes place, (assuming total energy gradient, slope of water surface, and grade of channel are the same)
- n** Coefficient of roughness used in the Manning formula for open channels or pipes
- L** Length of weir crest in feet or length of a channel
- D** Distance
- M** Mass
- W** Weight or width
- Pr** lb/sq/ft (to obtain lb/sq/inch divide by 144)
- F** Force
- WS** Water surface
- NWS** Normal water surface of a lake or stream
- HWS** High water surface of a lake or stream
- LWS** Low water surface of a lake or stream
- TWS** Tail water surface below a dam
- HW** Pool surface above a dam
- El.** Elevation above sea level

MISCELLANEOUS INFORMATION

Miscellaneous Information

Uses of Dams:

- Power** For head
- Storage** For all water uses
- Diversion** For water uses
- Flood control** Completely emptied
- Sediment control**
- Navigation** For depth and velocity control
- Multipurpose** Can be utilized for many water uses

Dam Nomenclature:

- Overflow section** or spillway
- Non-overflow section**
- Crest Top**
- Gravity** Method of security
- Arch** Method of security
- Gravity arch** Method of security
- Rock fill** Gravity types
- Dirt fill** Gravity types
- Training walls** Means of directing flow
- Head** Usually in feet and defined as useful difference in elevation for T.W. to H.W.

Miscellaneous Definitions

Power House:

- Tail race** Below the units
- Draft tube** Conduit from a turbine
- Penstock** Intake to a turbine
- Turbine** A water wheel to obtain power
- Generator** Electrical unit to generate power
- Deck** Walking or work surface
- Outlet works** In tail race
- Outlet towers** Means of water control to inlet
- Trash rack** A protective structure

Spillway:

- Gated** Use of a gate for control of spill or HW
- Weir** No control
- Apron** To prevent scour below a spillway
- O.G. (ogee or ogive)** Shape of spillway
- Ski jump** Shape of spillway
- Tainter or radial gates** Segments of circles
- Drum gates** Circular
- Needle bars or logs** Vertical
- Stop logs** Horizontal

MISCELLANEOUS INFORMATION

Comparison of 1 Cubic Foot and 1 Cubic Meter Ratio 1:35.3357

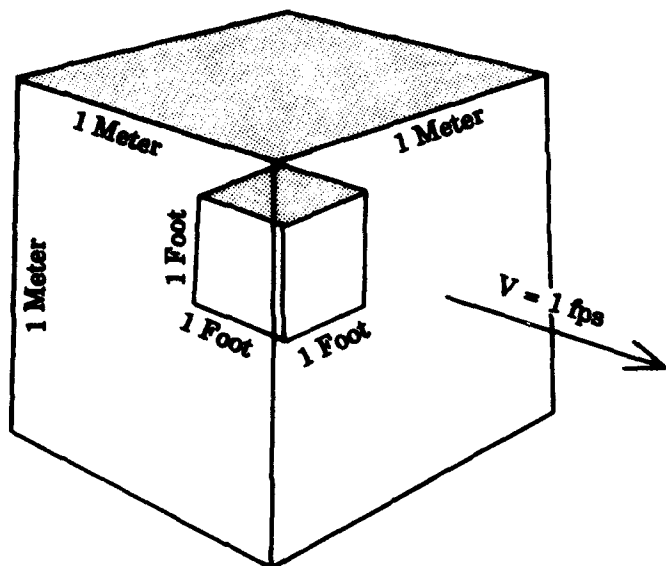

The above illustration is a comparison of 1 cubic foot and 1 cubic meter of water. When moving at 1 fps, they are called: second foot, cubic foot per second (cfs) or cubic meter per second.

One cubic foot per second is equal to 1.983 acre-feet of water in 24 hours, flowing from storage or into a storage reservoir.

It is equal to 7.48 gallons per second, 448.8 gallons per minute, or 646,317 gallons per day.

One cubic meter of water contains 1,000 liters. One liter is equal to .001 cubic meters, .2642 gallons, or 1.0566 quarts.

Basic Formulas English System

$$Q = AV$$

$$V = \sqrt{2gh}$$

$$P = Wh$$

$$V = C\sqrt{RS} \quad \text{where}$$

$$h = \frac{V^2}{2g}$$

$$h = \frac{P}{W}$$

$$R = \frac{A}{P}$$

$$Q = 3.33 LH^{3/2}$$

With a sharp-edged weir (Cipolletti weir), side contraction is accounted for. Value of 3.33 changes with shape of weir crest.

MISCELLANEOUS INFORMATION

Some Pipe and Circle Areas For Use in Hydraulics

STD. WT. STEEL & W.I. PIPE						CIRCLES		
Nom. Size	ID ins.	ID ft.	TH. ins.	ID ^{0.25} ft. ^{0.25}	A ₂ ft.	DIA	DIS ^{0.25} ft. ^{0.25}	A ₂ ft.
1/2	0.622	0.0519	.109	0.477	0.00211	0.0416	0.451	0.00136
3/4	0.824	0.0687	.113	0.512	0.00371	0.0625	0.500	0.00309
1	1.049	0.0874	.133	0.544	0.00600	0.0833	0.531	0.00545
1-1/4	1.380	0.1150	.140	0.582	0.01040	0.1041	0.568	0.00852
1-1/2	1.610	0.1342	.145	0.605	0.01414	0.125	0.593	0.01225
2	2.067	0.1722	.154	0.644	0.02330	0.167	0.638	0.0218
2-1/2	2.469	0.2057	.203	0.673	0.03322	0.2082	0.675	0.0341
3	3.068	0.2557	.216	0.711	0.05130	0.250	0.707	0.0491
3-1/2	3.548	0.296	.226	0.738	0.06870	0.292	0.735	0.0668
4	4.026	0.336	.237	0.761	0.08840	0.333	0.759	0.0873
5	5.047	0.420	.258	0.804	0.1390	0.416	0.803	0.1364
6	6.065	0.506	.280	0.842	0.2006	0.500	0.840	0.1963
8	7.981	0.665	.322	0.902	0.3474	0.667	0.903	0.3491
10	10.02	0.836	.365	0.956	0.5475	0.833	0.955	0.5454
12	12.00	1.000	.375	1.000	0.7854	1.000	1.000	0.7854
14 OD	13.25	1.105	.375	1.024	0.9569	1.167	1.040	1.069
16 OD	15.25	1.270	.375	1.062	1.268	1.333	1.072	1.396
18 OD	17.25	1.438	.375	1.092	1.623	1.500	1.108	1.768
20 OD	19.25	1.605	.375	1.126	2.021	1.667	1.138	2.182
24 OD	23.25	1.938	.375	1.180	2.949	2.000	1.189	3.142

WT - Wrought
WI - Wrought Iron
ID - Inside diameter

TH - Wall thickness
A - Area squared

Beaufort Scale of Wind Velocity

Beaufort Number	Wind velocity (mph)	Former terms used in weather forecast	
0	1	Less than Calm	Smoke rises vertically; no movement of leaves, bushes, trees, or grass.
1	1-3	Very light	Direction of wind shown by smoke drift; tall grass and weeds sway slightly; quaking aspen leaves move; small branches move gently; dead leaves on oaks rustle.
2	4-7	Light	Wind felt on face; trees of pole size in open sway gently; small branches of pine move noticeably; dead, dry leaves rustle and move; stands of broom sedge sway.
3	8-12	Gentle	Leaves and small twigs in motion; dry leaves on ground blow about; twigs of hardwood trees move distinctly, and large branches of pine in the open toss; whole trees in dense stands sway; trees of pole size in the open sway noticeably.
4	13-18	Moderate	Small branches move; tops of large hardwood trees sway noticeably; pines of pole size in open sway violently; whole trees in dense stands sway noticeably.
5	19-24	Fresh	Inconvenience is felt in walking against wind; branchlets are broken from trees; small trees in leaf sway; entire hardwood trees sway, their tips whip about violently; twigs broken from pines.
6	25-38	Strong	Progress is impeded when walking against wind; large branches in motion; branches broken from hardwood trees and tops from conifers.

MISCELLANEOUS INFORMATION

Wind Chill Chart Actual Thermometer Reading F.*

Estimated Wind Speed MPH	50	40	30	20	10	0	-10	-20	-30	-40	-50
	Equivalent Temperature F.										
Calm	50	40	30	20	10	0	-10	-20	-30	-40	-50
5	48	37	27	16	6	-5	-15	-26	-36	-47	-57
10	40	28	16	4	-9	-21	-33	-46	-58	-70	-83
15	36	22	9	-5	-18	-36	-45	-58	-72	-85	-99
20	32	18	4	-10	-25	-39	-53	-67	-82	-96	-110
25	30	16	0	-15	-29	-44	-59	-74	-88	-104	-118
30	28	13	-2	-18	-33	-48	-63	-79	-94	-109	-125
35	27	11	-4	-20	-35	-49	-67	-83	-98	-113	-129
40	26	10	-6	-21	-37	-53	-69	-85	-100	-116	-132
Wind speeds greater than 40 MPH have little additional effect.	LITTLE DANGER FOR PROPERLY CLOTHED PERSON			INCREASING DANGER				GREAT DANGER			
	DANGER FROM FREEZING OF EXPOSED FLESH										

Taken from "Emergency Preparedness Today" by Robert Stoffel, Washington State Department of Emergency Services, June, 1979.

To use the chart, find the estimated or actual wind speed in the left-hand column and the actual temperature in degrees F. in the top row. The equivalent temperature is found where these two intersect. For example, with a wind speed of 10 mph and a temperature of -10 F., the equivalent temperature is -33 F. This lies within the zone of increasing danger of frostbite, and protective measures should be taken. It is emphasized that the wind chill chart is of value in predicting frostbite only to exposed flesh. Outdoorsmen can easily be caught out in 30 F. temperature. Winds of 30 mph will produce an equivalent wind-chill temperature of 20 below zero.

*Inanimate objects are only affected by recorded temperatures.

MISCELLANEOUS INFORMATION

Relative Humidity Tables

Wet-bulb Temperature in F.

Dry Bulb Temperature (F.°)	40	42	44	46	48	50	52	54	56	58	60	62	64	66	68	70	72	74	76	78	80	82
40																						
42	85																					
44	71	85																				
46	58	72	86																			
48	47	60	78	86																		
50	38	49	61	74	87																	
52	29	40	51	63	75	87																
54	22	32	42	53	64	76	88															
56	16	25	34	44	55	65	76	88														
58	10	18	27	37	46	56	66	77	88													
60	5	13	21	30	39	48	58	68	78	89												
62	1	8	16	24	32	41	50	59	69	79	89											
64		4	11	18	26	34	43	51	60	70	79	90										
66			7	14	21	29	36	44	53	61	71	80										
68			3	10	16	23	31	38	46	54	62	71	90									
70				6	12	19	25	33	40	48	55	64	72	81	90							
72				3	9	15	21	28	34	42	49	57	65	73	82	91						
74					5	11	17	23	29	36	43	50	58	65	74	82	91					
76					3	8	13	19	25	31	38	44	51	59	66	74	82	91				
78						5	10	16	21	27	33	39	46	53	60	67	75	83	91			
80						3	7	12	18	23	29	35	41	47	54	61	68	75	83	91		
82							5	10	14	20	25	30	36	42	48	55	61	69	76	84	92	
84							3	7	12	16	21	26	32	37	43	49	56	62	69	76	84	92
86							1	5	9	14	18	23	28	33	39	44	50	57	63	70	77	84
88								3	7	11	15	20	25	30	35	40	46	51	57	64	70	77
90								1	5	9	13	17	22	26	31	36	41	47	52	58	65	71

CORRECTION FOR ELEVATION. The relative humidity at any given temperature rises slightly with increased elevation owing to a reduction in atmospheric pressure. The relative humidity indicated may be corrected by *adding* 1 percent when used at elevations between 500 and 1,999 ft. (e.g., for a dry-bulb temperature of 50° and a wet-bulb temperature of 40°, read 38 + 1, or 39 percent); 2 percent between 2,000 ft. and 3,999 ft.; 3 percent between 4,000 ft and 5,999 ft.; and 5 percent for elevations above 6,000 ft.

Air Temperature in F.

	40	45	50	55	60	65	70	75	80	85	90	95
Difference between the Dry and Wet Bulb.	0	100	100	100	100	100	100	100	100	100	100	100
	1	92	92	93	94	94	95	95	95	96	96	96
	2	84	85	87	88	89	90	90	91	92	92	92
	3	76	78	80	82	84	85	86	87	87	88	88
	4	68	71	74	76	78	80	81	82	83	84	85
	5	60	64	67	70	73	75	77	78	79	80	81
	6	53	58	61	65	68	70	72	74	75	77	78
	7	45	51	55	59	63	65	68	70	72	73	75
	8	38	44	50	54	58	61	64	66	68	70	71
	9	30	38	44	49	53	56	60	62	64	66	68
	10	22	32	38	43	48	52	55	58	61	63	65
	11	16	25	33	39	44	48	52	55	57	60	62
	12	8	19	27	34	39	44	48	51	54	56	59
	13	1	13	22	29	34	39	44	47	51	53	56
	14		7	16	24	30	35	40	44	47	50	53
	15		1	11	19	26	31	36	40	44	47	50
	16			6	16	22	28	33	37	41	44	47
	17			1	10	18	24	29	34	38	41	44
	18				6	14	20	26	31	35	38	41
	19				1	10	17	23	27	32	36	39
	20					6	13	19	24	29	33	36

MISCELLANEOUS INFORMATION

Lethal Distance from Explosion (Ft.)

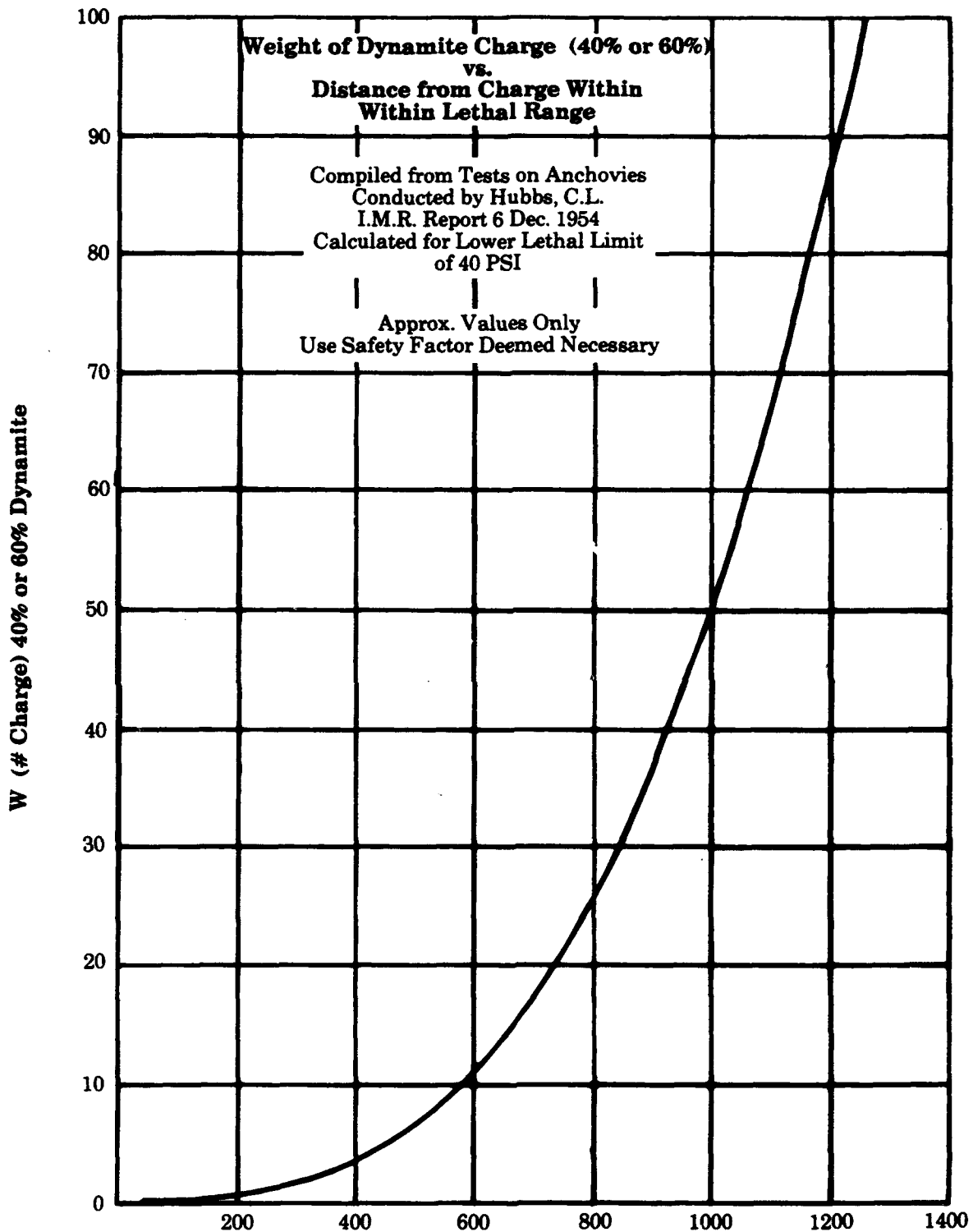

The pressure wave as reported deteriorates at a rate of $D^{-2.6}$ (D = distance in feet) from the center of the explosion. The negative wave is the most detrimental to fish with swim bladders. Oysters and clams show no damage at fish-killing levels. Buried shots reduce the level of kill.

MISCELLANEOUS INFORMATION

Nomogram Showing the Solubility of Oxygen in Water

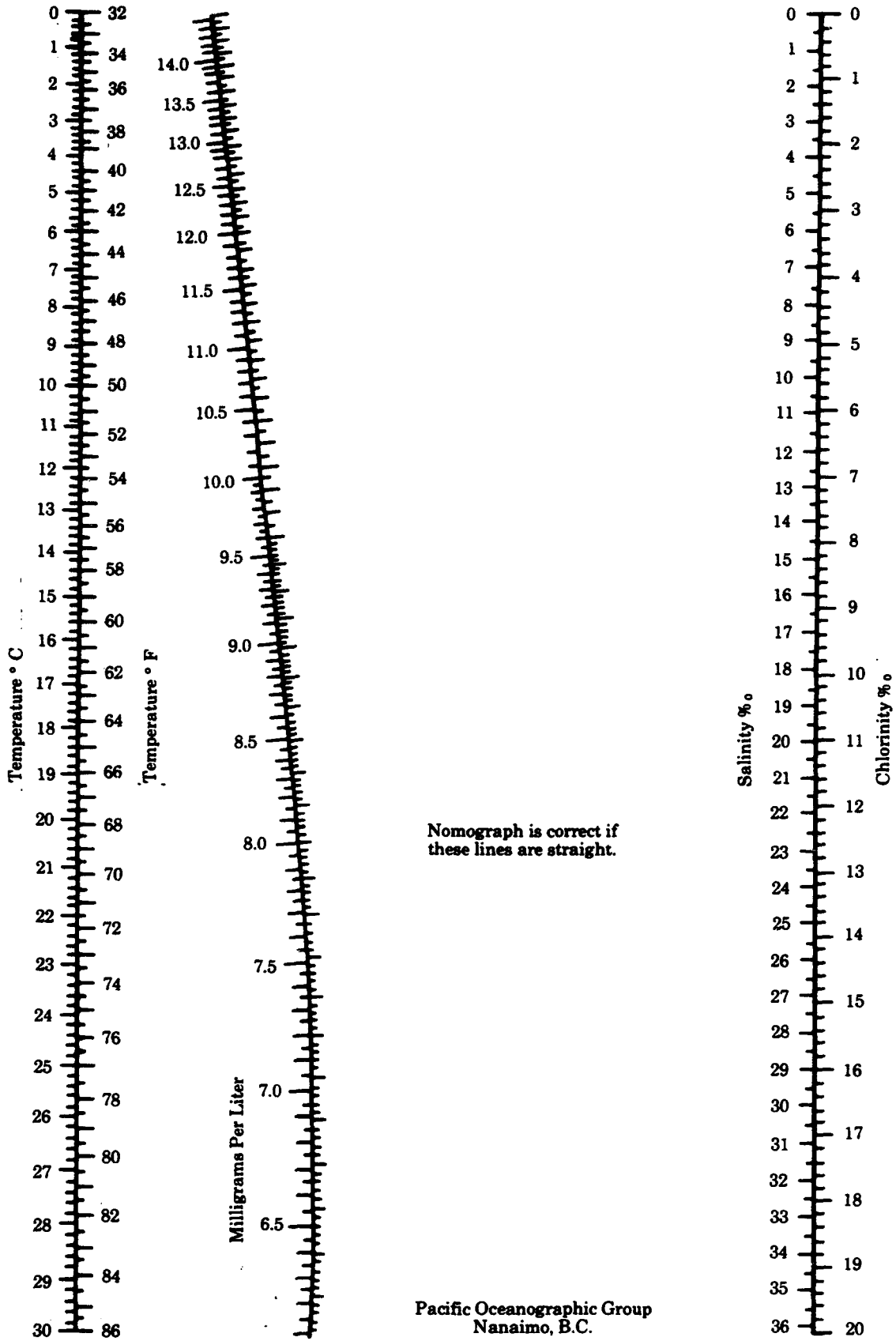

MISCELLANEOUS INFORMATION

Nomogram for Determining N₂ (with A₂) at ATM Pressure and Different Temperatures

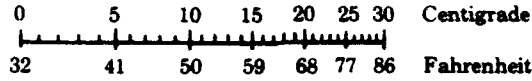

Water Temperatures

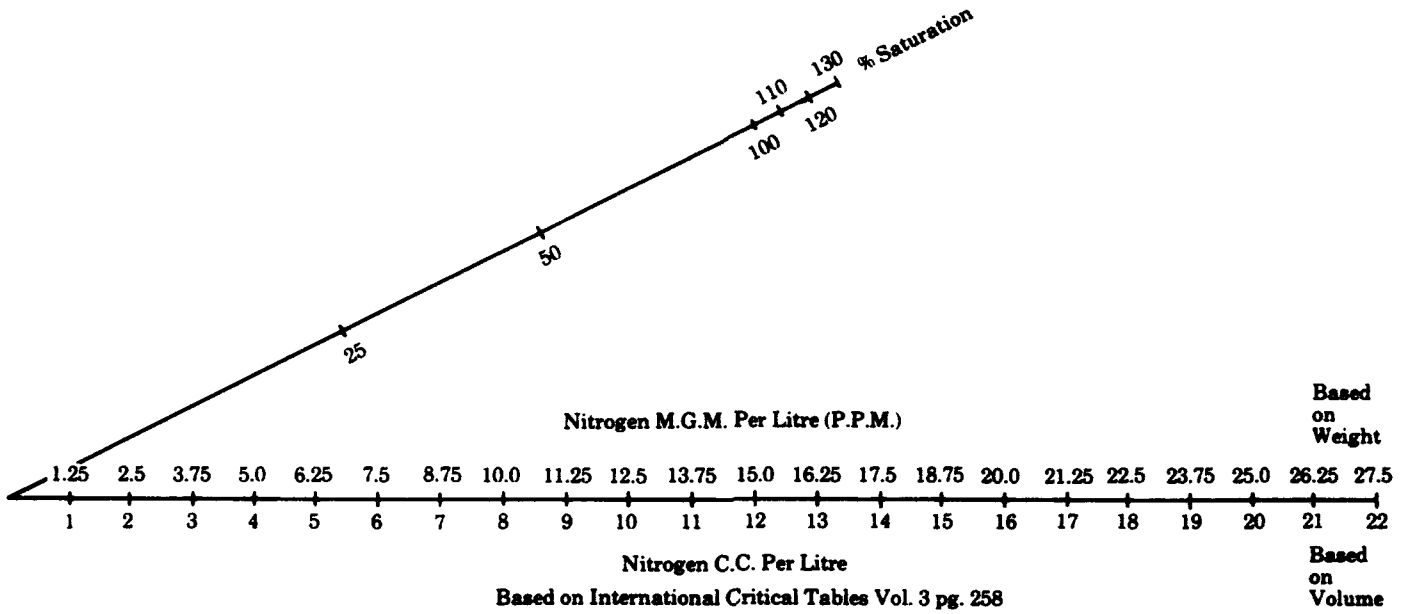

Nomogram for Determining O₂ Saturation at Different Temperatures and Altitudes (Mortimer)

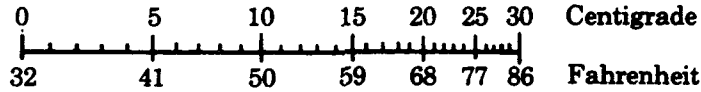

Water Temperatures

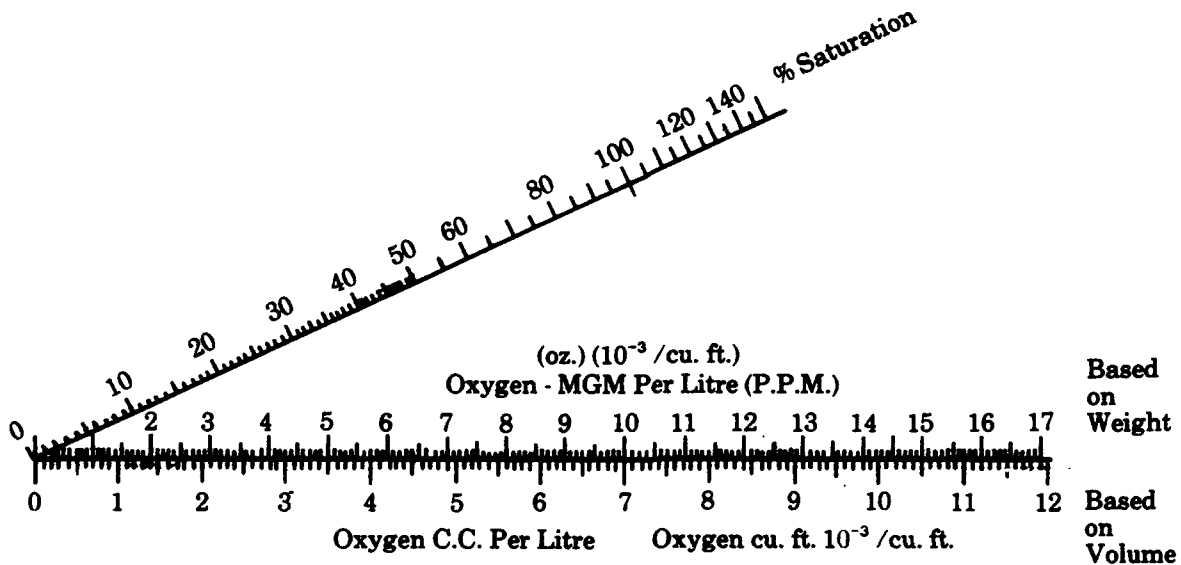

From Hutchinson

Chapter 2

Definitions of Common Terms in Use

DEFINITIONS OF COMMON TERMS IN USE

Aerobic Organism - An organism that thrives in the presence of oxygen.

Algae - Simple plants, many microscopic, containing chlorophyll. Most algae are aquatic and may produce a nuisance when environmental conditions are suitable for prolific growth.

Allocation - The process of legally dedicating specific amounts of the water resource for application to beneficial uses by means of water rights.

Alluvium - Stream deposits of comparatively recent time.

Ambient - The natural conditions (or environment) at a given place or time.

Anadromous Fishes - Fishes that spend a part of their life in the sea or lakes, but ascend rivers at more or less regular intervals to spawn. Examples are salmon, some trout, shad, and striped bass.

Aquifer - An underground bed or stratus of earth, gravel, or porous stone which contains water. A geological rock formation, bed, or zone that may be referred to as a water-bearing bed.

Anaerobic Organisms - Microorganisms that thrive best, or only, when deprived of oxygen.

Autotrophic - Self-nourishing; denoting green plants and those forms of bacteria that do not require organic carbon or nitrogen, but can form their own food out of inorganic salts and carbon dioxide.

Base Flow - As defined in the Water Resources Act of 1971 (Ch. 90.54 RCW), base flows are the flows administratively established "necessary to provide for the preservation of wildlife, fish, scenic, aesthetic and other environmental values, and navigational values."

Benthos - Bottom dwelling organisms.

Benthic Region - The bottom of a body of water.

Bio-assay - A determination of the concentration of a given material by comparison with a standard preparation, or the determination of the quantity necessary to affect a test animal under stated laboratory conditions.

Biochemical Oxygen Demand (BOD) - The amount of oxygen required to decompose a given amount of organic compounds to simple, stable substances within a specified time at a specified temperature. BOD serves as a guide to indicate the degree of organic pollution in water.

Biomass - The weight of all life in a specified unit of environment or an expression of the total mass or weight of a given population, both plant and animal.

Biota - All living organisms of a region.

Bloom - A readily visible concentrated growth or aggregation of plankton (plant and animal).

Coliform - Any of a number of organisms common to the intestinal tract of man and animals, used as an indicator of water pollution.

Consumptive Use - The amount of water used in such a way that it is no longer directly available. Includes water discharged into the air during industrial uses, or given off by plants as they grow (transpiration), or water which is retained in the plant tissues, or any use of water which prevents it from being directly available.

Control Station - Any streamflow measurement site at which a regulatory base flow has been established.

Dissolved Oxygen (DO) - Amount of oxygen dissolved in water.

Diversion - The physical act of removing water from a stream or other body of surface water.

Drainage Area - The area of land drained by a stream, measured in the horizontal plane. It is the area enclosed by a drainage divide.

Drainage Basin - A part of the surface of the earth that is occupied by a drainage system consisting of a surface stream of a permanent body of water together with all tributary streams and bodies of impounded water (lakes, ponds, reservoirs, etc.).

Dystrophic Lakes - Brown-water lakes with a very low lime content and a very high humus content. These lakes often lack nutrients.

Ecology - The science of the interrelations between living organisms and their environment.

Ecosystem - An ecological system; the interaction of living organisms and the nonliving environment producing an exchange of materials between the living and the nonliving.

Effluent - A discharge or emission of a liquid or gas, usually waste material.

Emission - A discharge of pollutants into the atmosphere, usually as a result of burning or the operation of internal combustion engines.

Endangered Species - any species which, as determined by the Fish and Wildlife Service, is in danger of extinction throughout all or a significant portion of its range other than a species of the class Insecta determined to constitute a pest whose protection would present an overwhelming and overriding risk to man.

Epilimnion - That region of a body of water that extends from the surface to the thermocline and does not have a permanent temperature stratification.

Escapement - Adult fish that "escape" fishing gear to migrate upstream to spawning grounds.

Estuary - Commonly an arm of the sea at the lower end of a river. Estuaries are often enclosed by land except at channel entrance points.

Eulittoral Zone - The shore zone of a body of water between the limits of water-level fluctuation.

Euphotic Zone - The lighted region that extends vertically from the water surface to the level at which photosynthesis fails to occur because of ineffective light penetration.

DEFINITIONS OF COMMON TERMS IN USE

Euryhaline Organisms - Organisms that are able to live in waters of a wide range of salinity.

Eurytopic Organisms - Organisms with a wide range of tolerance to a particular environmental factor. Examples are slidgeworms and bloodworms.

Eutrophication - The intentional or unintentional enrichment of water.

Eutrophic Waters - Waters with a good supply of nutrients. These waters may support rich organic productions, such as algal blooms.

Fall Overturn - A physical phenomenon that may take place in a body of water during the early autumn. The sequence of events leading to fall overturn include (1) cooling of surface waters, (2) density change in surface waters producing convection currents from top to bottom, (3) circulation of the total water volume by wind action, and (4) vertical temperature equality, 4 degrees C. The overturn results in a uniformity of the physical and chemical properties of the water.

Fingerlings - Fish whose size ranges from approximately one to three inches.

Floc - A small, light, loose mass, as of a fine precipitate.

Flood - Any relatively high streamflow or an overflow that comes from a river or body of water and which causes or threatens damage.

Flood Plain - Lowland bordering a river, subject to flooding when stream overflows.

Food-Chain - The dependence of organisms upon others in a series for food. The chain begins with plants or scavenging organisms and ends with the largest carnivores.

Fry (sac fry or alevin) - The stage in the life of a fish between the hatching of the egg and the absorption of the yolk sac. From this stage until they attain a length of one inch the young fish are considered advanced fry.

Gaging Station - A particular location on a stream, canal, lake, or reservoir where systematic measurements are made on the quantity of water flow.

Ground Water - Water in the ground lying in the zone of saturation. Natural recharge includes water added by rainfall, flowing through pores or small openings in the soil into the water table.

Habitat - The natural abode of a plant or animal, including all biotic, climatic, and soil conditions, or other environmental influences affecting life.

Heavy Metals - A group that includes all metallic elements with atomic numbers greater than 20, the most familiar of which are chromium, manganese, iron, cobalt, nickel, copper and zinc but that also includes arsenic, selenium, silver, cadmium, tin, antimony, mercury, and lead, among others.

Herbivore - An organism that feeds on vegetation.

Heterotrophic Organisms - Organisms that are dependent on organic matter for food.

Holdovers - Fish that take up residence in reservoirs rather than completing migration to the sea; may complete migration the following year.

Holomictic Lakes - Lakes that are completely circulated to the bottom at time of winter cooling.

Homoiothermic Animals - Animals that possess a temperature-regulating mechanism to maintain a more or less constant body temperature (warm-blooded animals).

Hydrologic Cycle - The continual exchange of moisture between the earth and the atmosphere, consisting of evaporation, condensation, precipitation (rain or snow), stream runoff, absorption into the soil, and evaporation in repeating cycles.

Hypolimnion - The region of a body of water that extends from the thermocline to the bottom of the lake and is removed from surface influence.

Impoundment - A body of water formed by confining and storing the water.

Lenitic or Lentic Environment - Standing water and its various intergrades, as lakes, ponds and swamps.

Limnetic Zone - The open-water region of a lake.

Littoral Zone - The shoreward region of a body of water.

Lotic Environment - Running waters, as streams or rivers.

Median Lethal Dose (LD₅₀) - Dose lethal to 50 per cent of a group of test organisms for a specified period. The dose material may be ingested or injected.

Median Tolerance Limit (TL_m) - Concentration of the tested material in a suitable diluent (experimental water) at which just 50 per cent of the test animals are able to survive for a specified period of exposure.

Meromictic Lakes - Lakes in which dissolved substances create a gradient of density differences in depth, preventing complete mixing or circulation of the water.

Nanoplankton - Very small plankton not retained by a plankton net equipped with No. 25 silk bolting cloth.

Nekton - Swimming organisms able to navigate at will.

Neuston - Organisms resting or swimming on the surface film of the water.

Nonconsumptive Use - Use of water in a manner which does not consume the resource. Fishery, aesthetic, and hydropower uses are examples of nonconsumptive use.

Oligotrophic Waters - Waters with a small supply of nutrients, supporting little organic production.

Oxygen-Debt - A phenomenon that occurs in an organism when available oxygen is inadequate to supply the respiratory demand. During such a period the metabolic processes result in the accumulation of breakdown products that are not oxidized until sufficient oxygen becomes available.

DEFINITIONS OF COMMON TERMS IN USE

- Pelagic Zone** - The free-water region of a large body of water.
- Periphyton** - The association of aquatic organisms attached or clinging to stems and leaves of rooted plants or other surfaces projecting above the bottom.
- Photosynthesis** - The process by which simple sugars and starches are produced from carbon dioxide and water by living plant cells, with the aid of chlorophyll and in the presence of light.
- Phototropism** - Movement in response to a light gradient.
- Phytoplankton** - Plant plankton that live unattached in water.
- Piscicide** - Substances or a mixture of substances intended to destroy or control fish populations.
- Plankton (Plankter)** - Organisms of relatively small size, mostly microscopic, that have either relatively small powers of locomotion or that drift in the water with waves, currents, and other water motion.
- Poikilothermic Animals** - Animals that lack a temperature-regulating mechanism that offsets external temperature changes (cold-blooded animals). Their temperature fluctuates to a large degree with that of their environment. Examples are fish, shellfish and aquatic insects.
- Potamology** - Study of the physical, chemical, geological and biological aspects of rivers.
- Primary Productivity** - The rate of photosynthetic carbon fixation by plants and bacteria forming the base of the food chain.
- Profundal Zone** - The deep and bottom-water area beyond the depth of effective light penetration. All of the lake floor beneath the hypolimnion.
- Public Waters** - All waters not previously appropriated.
- Rearing area** - The place where juvenile fish live. It must meet certain environmental requirements for food supply, cover, and temperature.
- Redd (Nest)** - A type of fish-spawning area associated with running water and clean gravel.
- Reservation** - An approved priority claim to water for a future beneficial use.
- Rheotropism** - Movement in response to the stimulus of a current gradient in water.
- Riparian** - Pertaining to the banks of streams, lakes, or tidewater.
- Riffle** - A section of a stream in which the water is usually more shallow and the current is of greater velocity than in the connecting pools; a riffle is smaller than a rapid and more shallow than a chute.
- River Basin** - The total area drained by a river and its tributaries; watershed; drainage basin.
- Run** - A group of fish that ascend a river to spawn.
- Runoff** - That part of precipitation which appears in surface streams. This is the streamflow before it is affected by artificial diversion, reservoirs, or other man-made changes in or on stream channels.
- Salmonoid** - Fish belonging to the family salmonidae, including salmon, trout, char, and allied freshwater and anadromous fishes.
- Seiche** - A form of periodic current system, described as a standing wave, in which some stratum of the water in a basin oscillates about one or more nodes.
- Sessile Organisms** - Organisms that sit directly on a base without support, attached or merely resting unattached on a substrate.
- Seston** - The living and nonliving bodies of plants or animals that float or swim in the water.
- Smolt** - An anadromous fish that is physiologically ready to undergo the transition from fresh to salt water; age varies depending on species and environmental conditions.
- Smoltification** - The biological process whereby an anadromous fish becomes capable of undergoing the transition from fresh to salt water.
- Spawning** - The laying of eggs, especially by fish.
- Spring Overturn** - A physical phenomenon that may take place in a body of water during the early spring. The sequence of events leading to spring overturn include (1) melting of ice cover when present, (2) warming of surface waters, (3) density change in surface waters producing convection currents from top to bottom, (4) circulation of the total water volume by wind action, and (5) vertical temperature equality, 4 degrees C. The overturn results in a uniformity of the physical and chemical properties of the water.
- Stenotopic Organisms** - Organisms with a narrow range of tolerance for a particular environmental factor. Examples are trout, stonefly nymphs, oyster larvae, etc.
- Storage** - Water naturally or artificially impounded in surface or underground reservoirs.
- Storage reservoir** - A reservoir in which storage is held over from the annual high-water season to the following low-water season. Storage reservoirs which refill at the end of each annual high-water season are "annual storage" reservoirs. Those which cannot refill all usable power storage by the end of each annual high-water season are "cyclic storage" reservoirs.
- Streamflow** - The discharge or water flow that occurs in a natural channel. The word discharge can be applied to a canal, but streamflow describes only the discharge in a surface stream course. Streamflow applies to discharge whether or not it is affected by diversion or reservoirs.
- Sublittoral Zone** - The part of the shore from the lowest water level to the lower boundary of plant growth.
- Symbiosis** - Two organisms of different species living together, one or both of which may benefit and neither is harmed.

DEFINITIONS OF COMMON TERMS IN USE

Thermocline - That layer in a body of water where the temperature difference is greatest per unit of depth. It is the layer in which the drop in temperature equals or exceeds one degree C. (1.8 degrees Fah.) per meter (39.37 inches).

Trophogenic Region - The superficial layer of a lake in which organic production from mineral substances takes place on the basis of light energy.

Tropholytic Region - The deep layer of a lake, where organic dissimilation predominates because of light deficiency.

Turbidity - The cloudiness of water caused by the presence of suspended matter. These particles cause light to be scattered and absorbed rather than transmitted in straight lines. It is often measured in Jackson Turbidity Units (JTU).

Watershed - The area from which water drains to a single point. In a natural basin, the area contributing flow to a given place on a stream.

Zooplankton - Animal microorganisms living unattached in water. They include small crustacea, such as daphnia and cyclops, and single-celled animals as protozoa, etc.

Chapter 3

Legal

State, federal officers, commissions empowered to carry out intent of an act.

General statutes cover habitat protection.

Migrating fish protected by fishways and screening of intakes.

In lieu settlements (hatcheries, man-made spawning channels and purchase of fish from existing hatcheries).

Habitat protected by limiting pollution.

Lists of agencies with authority over aquatic resources.

Special sanctuaries set aside by legislative action.

Laws pertaining to flows in river channels.

Coordination of individual states and federal government.

Effect on State laws of Federal Court decisions on fishing rights of Native Americans.

References to early legal action.

Effect on State laws of instigation of the 200-mile zone.

Typical State laws from Revised Code of Washington (RCW).

LEGAL

The fishery resources at water development projects are protected by law under general statutes contained in State Codes and Public Laws of the Federal Government. Sections vary in wording among the states and their agencies and do not define the requirements to be fulfilled under a stated law. In most cases, discretionary powers are given to the State or Federal officers named by law to carry out the intent of an act. In some cases, commissions are so empowered.

Basically, passage of adult fish at dams is provided by the requirement of construction and operation of fishways; downstream migrants are protected from diversion from streams, lakes, ponds, estuaries, salt water areas and impoundments by the requirement of screening of intakes.

As alternatives to the above, in-lieu settlements may be allowed, such as the construction and operation of fish hatcheries or man-made spawning channels or the purchase of fish for planting from existing hatcheries.

If all or part of a diverted flow is returned to an aquatic area (such as processing or cooling water from steam electric plants), such return flows fall under pollution control regulations.

Following is a list of agencies that have authority over aquatic resources. The list may not be all inclusive. Some of the agencies have authority to issue water-use permits; others are authorized only to protect the aquatic resource.

- State fisheries agencies (food fish/commercial)
- State game fish agencies
- State fish and game agencies (combined)
- Water resource agencies (which may include the three mentioned above)
- Water conservation agencies (which may include water engineering)
- Bureau of Indian Affairs (acting for Treaty Tribes)
- Bureau of Land Management
- U.S. Forest Service
- National Parks Service
- Environmental Protection Agency
- Bureau of Reclamation
- U.S. Army Corps of Engineers
- Power Authorities (for production and sale of electrical energy)
- International commissions with authority to recommend action to preserve or extend a specific fishery.

Other agencies, such as the Federal Energy Regulatory Commission (FERC), have authority to modify the transfer of public water for use by individuals, corporations, businesses and governmental agencies. In some areas, Indian tribes claim ownership of the water and its uses.

All of the above-listed agencies have project authority to initiate research to protect and enhance aquatic resources.

Corps of Engineers has authority over navigation improvements, flood control and shoreline protection.

Bureau of Reclamation has authority to construct reservoirs and waterways for water conservation and its use for diversion and flood control.

Federal Energy Regulatory Commission (FERC) has authority to require basic types of approaches to the solution of fishery problems and the authority to make river basin decisions.

General statutes cover habitat protection by limiting types and quantities of pollutants that can be introduced into aquatic areas by limiting operations that damage stream beds or shorelines and by limiting water level changes in lakes and impoundments. Flood control projects and their operation fall generally under the regulations covering storage and release of water and some cases are modified by local laws.

In special cases, fish sanctuaries have been set aside by legislative action, such as the Wild and Scenic Rivers Act. The presence of endangered species may stop, delay or alter a water use project.

Of recent development are laws pertaining to the adequacy of flows in river channels, including both minimum and maximum flows required for maintenance of fish life.

The statutes of individual states and the acts of the Federal government require agencies involved in water use development to confer with each other for coordinating aquatic protection activities. Where the development of power involves Federal lands, agencies such as the Federal Energy Regulatory Commission (FERC) have been given primary authority to require comprehensive project planning or basin-type development and, hence, the language of each license issued has an important bearing in the decision making of all agencies involved. Classification of water purity by pollution control agencies may also result in protection to fish life.

Appropriation acts of the states and the Federal government may also contain language pertaining to the administration and requirement for fisheries protection at water use developments and should be reviewed for each project.

Since the Federal Court decisions affecting fishing rights of Native Americans and the instigation of the 200-mile zone, the basic State laws have been and are being modified to the extent that it is essential that all actions be reviewed to reflect the results of the above-mentioned changes. The legal aspects of fisheries management have been changed radically.

Recent legislation in certain states permits the development of private hatcheries and the use of the returning runs to a project.

The agency name shown in a law may have been altered, or the agency consolidated with another agency, sometimes resulting in a newly named agency. In almost all cases, the authority has been transferred to the new agency.

In addition to the authority given to fishery agencies, water uses may be modified by local planning authorities. Case law may also further define the authority of legally established agencies.

There is a long history leading to the present public laws for the protection of migratory fish, beginning with Magna

LEGAL

Charta. ("Magna Charta, or the great charter of King John, granted June 15, A.D. 1215." Old South Leaflets General Series, Volume 1, No. 5. Boston Directors of Old South Work, Boston, Massachusetts. 1896). On page 1, item 33 states: All kydeles (wiers) for the time to come shall be put down in the rivers of Thames and Medway, and throughout all England, except upon the sea-coast.

An excellent early summation of the ownership of land under the water, or the water over the land, is contained in "The history and law of fisheries" by Stuart A. Moore and Hubert Stuart Moore. (Stevens and Haynes, Law Publishers, Bell Yard, Temple Bar, London, England. 1903).

Reference to early federal laws in the United States is contained in "Compilation of federal laws, relating to the conservation and development of our nation's fish and wildlife resources - Part IV Fishways at river and harbor projects Act of August 11, 1885."

Over the years, these early acts have been amended and changed drastically, with the number of agencies involved being greatly expanded.

In addition to action by the agencies under their granted authority, in some cases civil action has been used by the states to obtain monetary reimbursement for the loss of aquatic resources under their stewardship.

Typical of state laws are those in the Revised Code of Washington (RCW). These are not necessarily inclusive for all states.

1. Washington Department of Fisheries, "Fisheries code relating to food fish and shellfish." (As set forth in Titles 43 and 75, Revised Code of Washington.) Olympia, Washington. 1964.

Chapter 75.20, Restrictions as to dams, ditches and other uses of waters and waterways. Sections

75.20.010-030, Columbia River Sanctuary; 75.20.040, Fish guards required; 75.20.050, Water flow to be maintained; 75.20.060, Fishways required in dams, obstructions...; 75.20.061, Director may modify, etc., inadequate fishways and protective devices; 75.20.070, Unlawful to fish in or interfere with fishways, screens, etc.; 75.20.080, Unlawful to interfere with or damage ladders, guards, etc.; 75.20.090, If fishway is impractical, fish hatcheries may be provided in lieu; 75.20.100, Hydraulic projects - plans must be approved; 75.20.110, Columbia River sanctuary - 1960 Act.

2. Washington State Game Department, "Game code of the State of Washington, 1964 edition." Olympia, Washington. 1964.

Sections 77.12.200, Hatcheries...; 77.16.210, Fishways and protective devices; 77.16.221,...modify inadequate fishways and protective devices; 77.16.160, Unlawful to molest fish screens; 77.16.220, Requirements.

3. Washington State Legislature (41st), First extraordinary session, "1969 session laws, Chapter 133 [Engrossed House Bill No. 305]." Olympia, Washington. 1969.

...new section to Chapter 90.48 RCW...oil pollution.

4. Washington State Legislature (41st), First extraordinary session, "1969 session laws, Chapter 284, House Bill No. 310." Olympia, Washington. 1969.

Section 3 (new section), ...establish minimum water flows or levels for streams, lakes or other public waters for purposes of protecting fish, game birds or other wildlife resources...

Chapter 4

Scientific and Common Names of Some of the More Abundant Fish Species

**Common and Scientific Names
of Selected Species.**

**Sketches of Commercial, Game
and Resident Species.**

**Maps showing general range
of stocks.**

SCIENTIFIC and COMMON NAMES of Some of the More Abundant Fish Species

Salmon

Chinook (*Oncorhynchus tshawytscha*)
 Coho (*Oncorhynchus kisutch*)
 Pink (*Oncorhynchus gorbusha*)
 Chum (*Oncorhynchus keta*)
 Sockeye (*Oncorhynchus nerka*)

Trout

Steelhead (*Salmo gairdneri*)*
 Rainbow (*Salmo gairdneri*)*
 Cutthroat (coastal) (*Salmo clarki*)*
 Brown (*Salmo trutta*)
 Golden (*Salmo aquabonita*)*
 Atlantic (*Salmo salar*)

Char

Brook trout (*Salvelinus fontinalis*)
 Dolly Varden (*Salvelinus malma*)
 Lake trout (*Salvelinus namaycush*)

Bass

Striped bass (*Morone saxatilis*)
 White bass (*Roccus chrysops*)
 Largemouth bass (*Micropterus salmoides*)
 Smallmouth bass (*Micropterus dolomieu*)
 Spotted bass (*Micropterus punctualatus*)

Bullhead

Yellow bullhead (*Ictalurus natalis*)
 Brown bullhead (*Ictalurus nebulosus*)
 Black bullhead (*Ictalurus melas*)

Catfish

Channel catfish (*Ictalurus punctatus*)
 White catfish (*Ictalurus catus*)

Crappie

Black crappie (*Pomoxis nigromaculatus*)
 White crappie (*Pomoxis annularis*)

Perch

Sacramento perch (*Archoplites interruptus*)
 Yellow perch (*Perca flavescens*)

Sturgeon

Sturgeon (green) (*Acipenser medirostris*)
 Sturgeon (white) (*Acipenser transmontanus*)

Sucker

Bridgelip sucker (*Catostomus columbianus*)
 Large scale sucker (*Catostomus macrocheilus*)
 Mountain sucker (*Catostomus platyrhynchus*)

Miscellaneous

Arctic Grayling (*Thymallus arcticus*)
 Bluegill (*Lepomis macrochirus*)
 Carp (*Cyprinus carpio*)
 Chiselmouth (*Acrocheilus alutaceus*)
 Columbia River Chub (peamouth)
 (*Mylocheilus caurinus*)
 Dace (*Rhinichthys* sp.)
 Pumpkinseed (*Lepomis gibbosus*)
 Roach (*Siphateles bicolor*)
 American shad (*Alosa sapidissima*)
 Redside shiner (*Richardsonius balteatus*)
 Smelt (eulachon) (*Thaleichthys pacificus*)
 Squawfish (*Ptychocheilus oregonensis*)
 Green Sunfish (*Lepomis cyanellus*)
 Whitefish (mountain) (*Prosopium williamsoni*)

* The American Fisheries Society Names of Fishes Committee met in Ann Arbor in October, 1988 and made the decision to change the scientific names of certain species of trout. The common names remain unchanged.

Old Name

Salmo gairdneri
Salmo clarki
Salmo aquabonita

New Name

Oncorhynchus mykiss
Oncorhynchus clarki
Oncorhynchus aquabonita

SCIENTIFIC and COMMON NAMES of Some of the More Abundant Fish Species

Commercial, Game and Resident Species

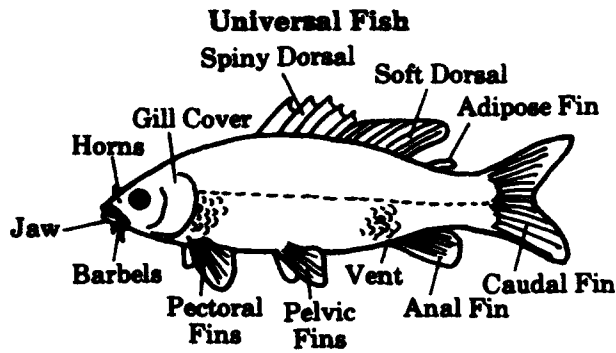

(Length given in inches is representative. There may be regional and local size variations.)

Salmon
(18-36 inches)

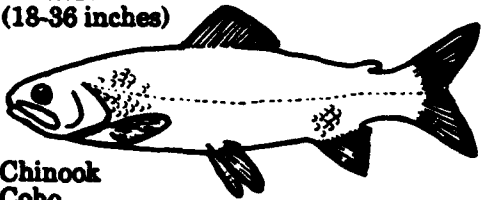

- Chinook
- Coho
- Pink
- Chum
- Sockeye
- Kokanee (landlocked sockeye)

Trout
(6-30 inches)

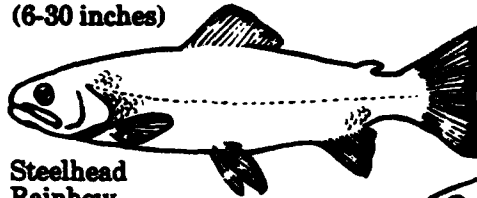

- Steelhead
- Rainbow
- Cutthroat (coastal)
- Brown
- Golden
- Atlantic

Char
(12-18 inches)

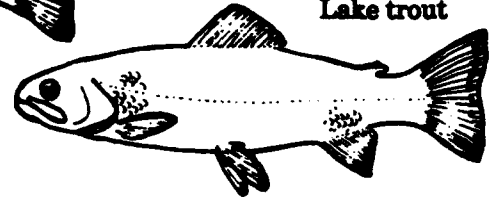

- Brook trout
- Dolly Varden
- Lake trout

Striped Bass
(14-30 inches)

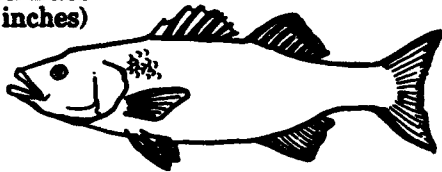

Largemouth Bass
(20-23 inches)

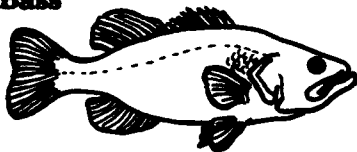

Smallmouth Bass
(10-19 inches)

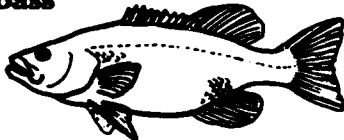

Blue Gill
(7-12 inches)

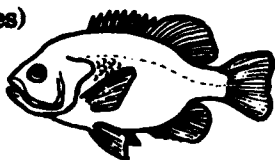

Black Bullhead
(6-8 inches)



Yellow Bullhead
Brown Bullhead
(6-8 inches)

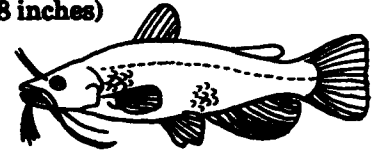

Carp
(15-24 inches)

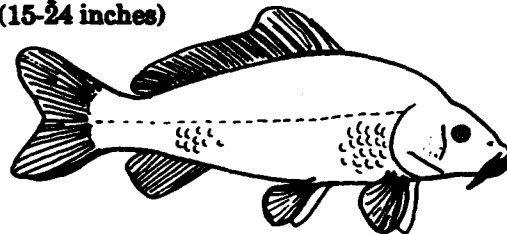

Channel Catfish
(10-16 inches)

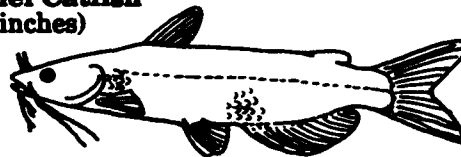

Chiselmouth
(6-7 inches)

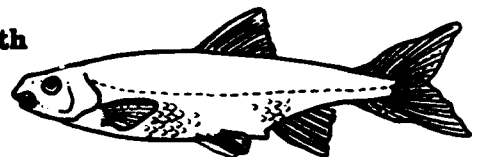

SCIENTIFIC and COMMON NAMES of Some of the More Abundant Fish Species

Columbia River Chub
(4-12 inches)

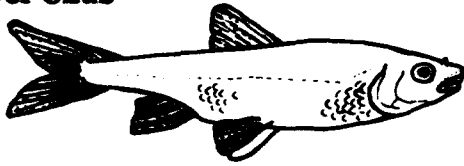

Redside Shiner
(2.3-3 inches)

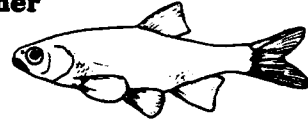

Black Crappie
(7-12 inches)

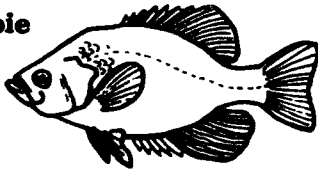

Smelt
(8-10 inches)

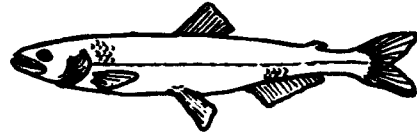

White Crappie
(7-12 inches)

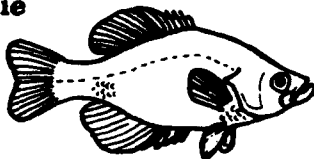

Squawfish
(24-36 inches)

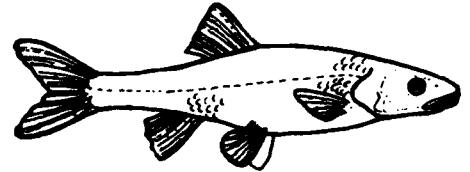

Dace
(2.3-3 inches)

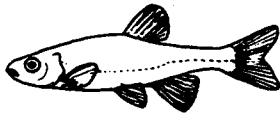

Green Sturgeon
(60-84 inches)



Sacramento Perch
(3.5-9 inches)

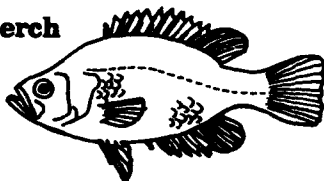

White Sturgeon
(60-156 inches)

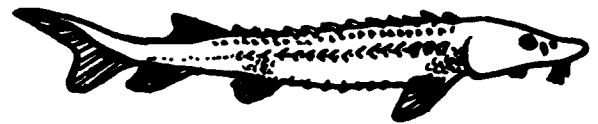

Yellow Perch
(5-12 inches)

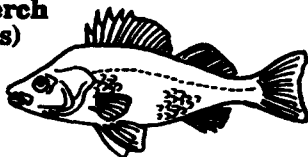

Bridgelip Sucker
(8-12 inches)

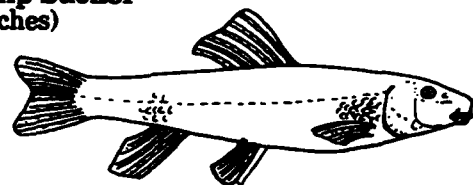

Pumpkinseed
(7-9 inches)



Roach
(3-5 inches)



Green Sunfish
(4-8 inches)



American Shad
(10-13 inches)

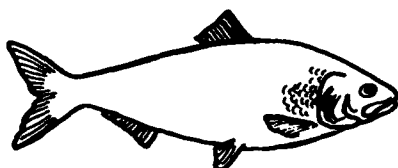

Whitefish
(17-22 inches)

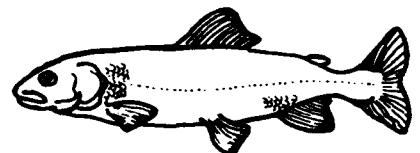

SCIENTIFIC and COMMON NAMES of Some of the More Abundant Fish Species

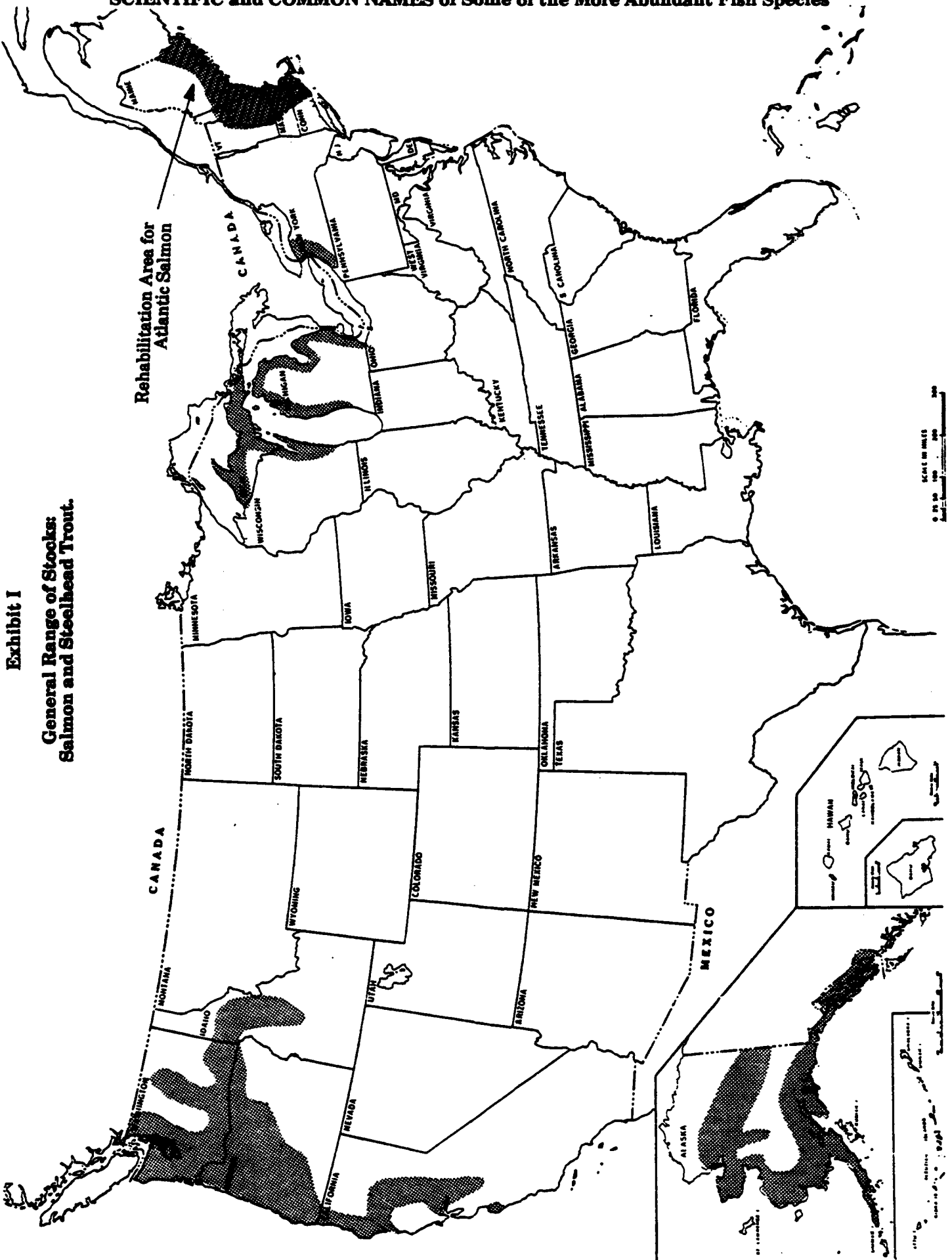
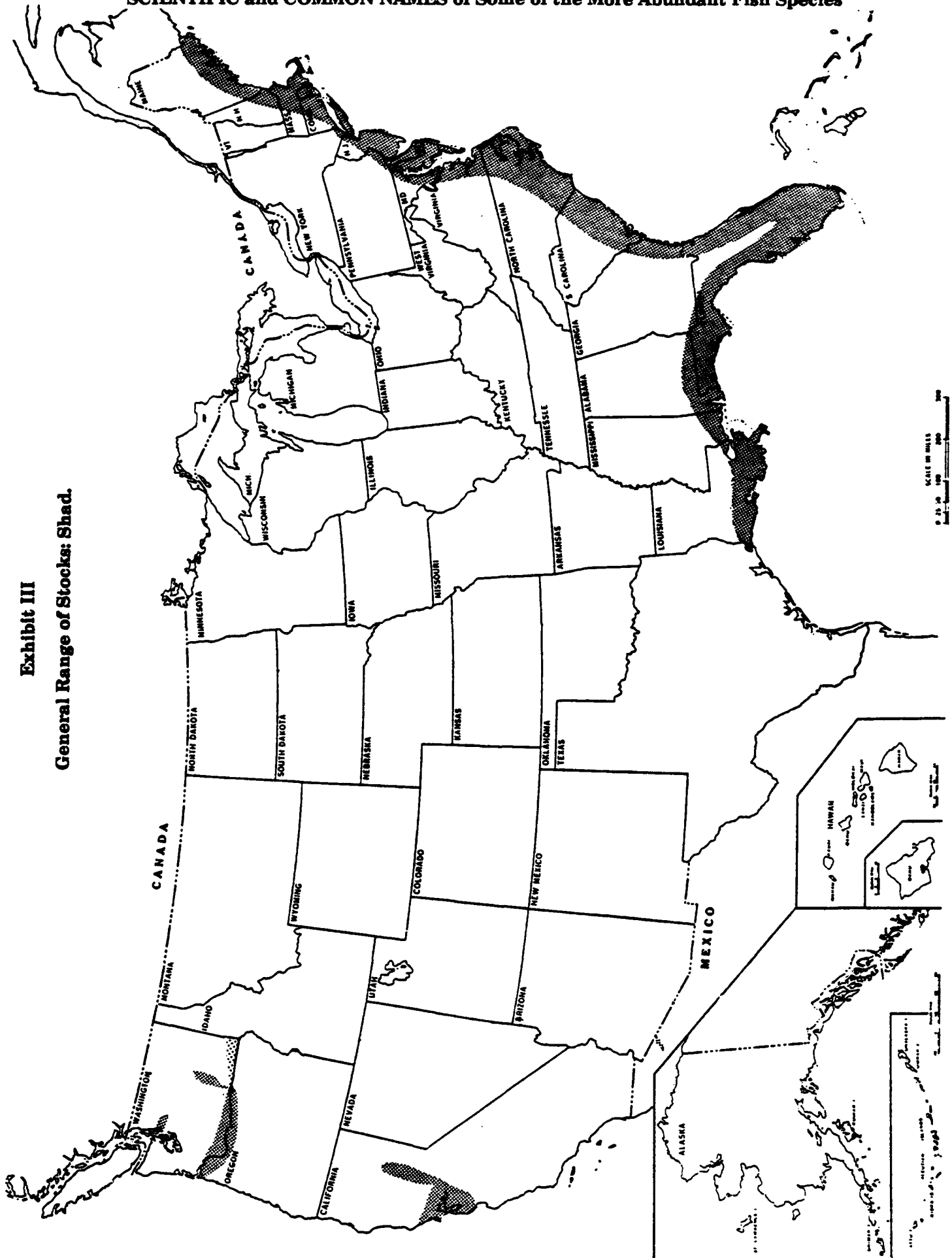

Exhibit I
General Range of Stocks:
Salmon and Steelhead Trout.

SCIENTIFIC and COMMON NAMES of Some of the More Abundant Fish Species

Exhibit III

General Range of Stocks: Shad.



SCIENTIFIC and COMMON NAMES of Some of the More Abundant Fish Species

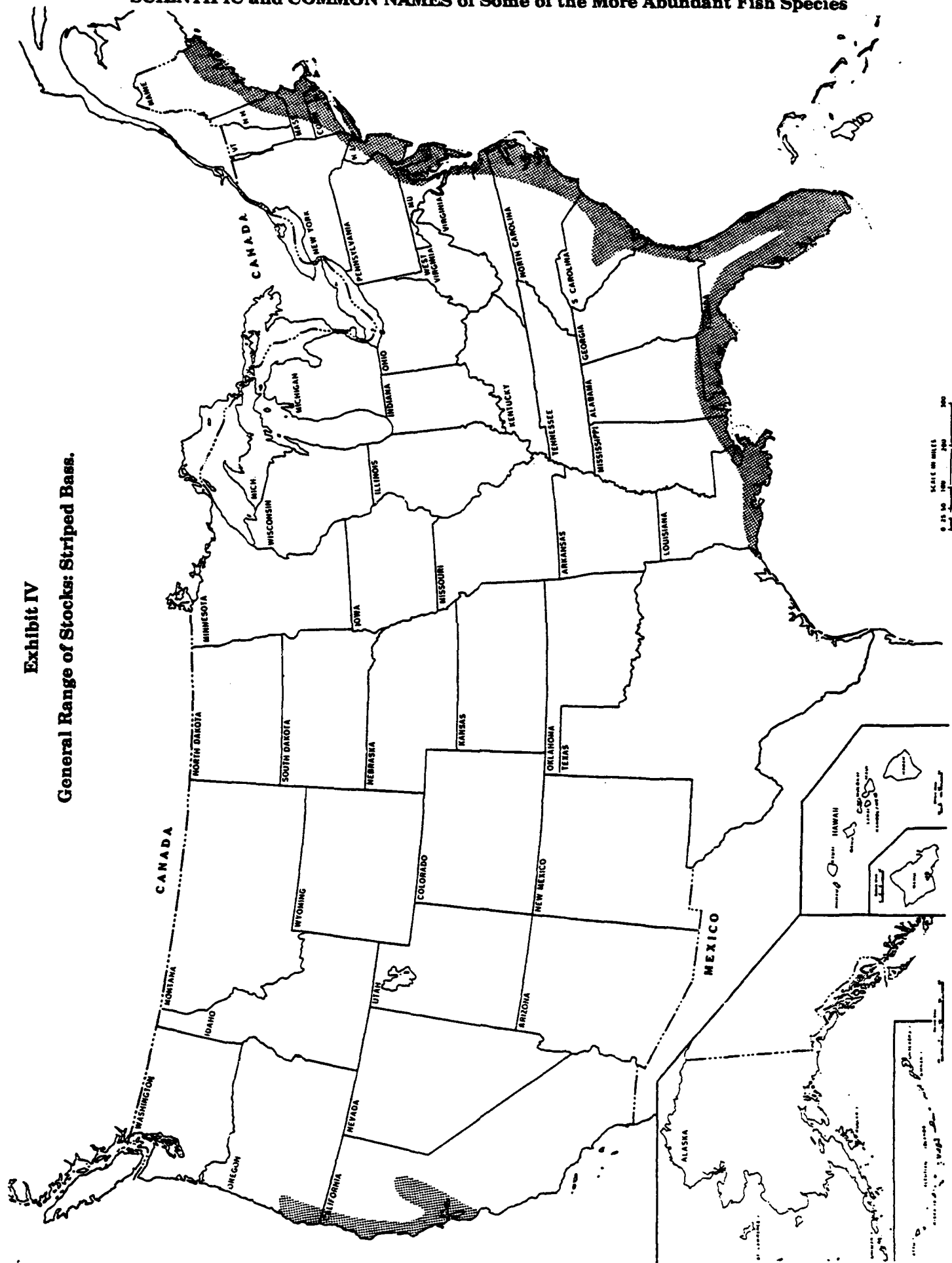
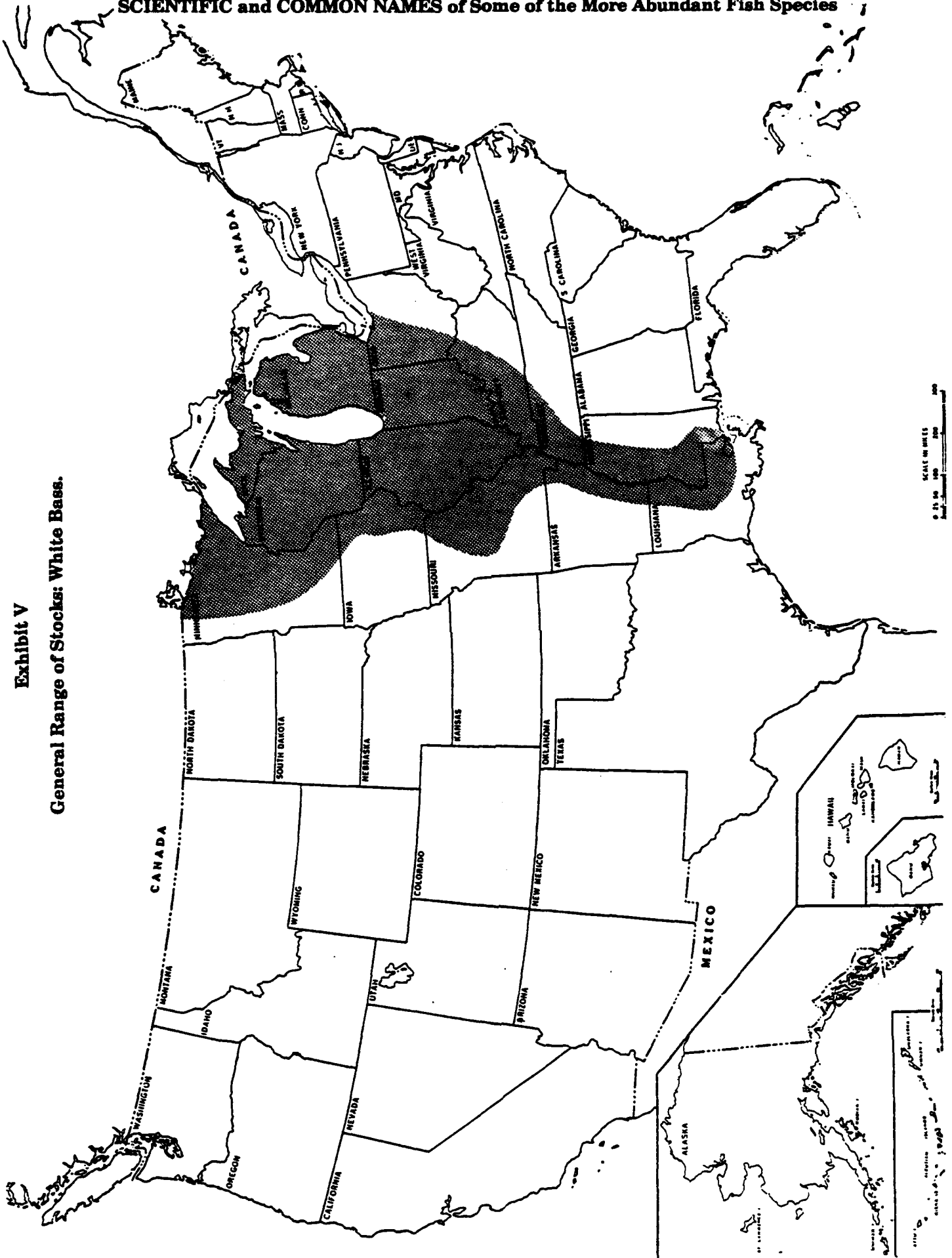

Exhibit IV

General Range of Stocks: Striped Bass.

SCIENTIFIC and COMMON NAMES of Some of the More Abundant Fish Species

Exhibit V
General Range of Stocks: White Bass.



SCIENTIFIC and COMMON NAMES of Some of the More Abundant Fish Species

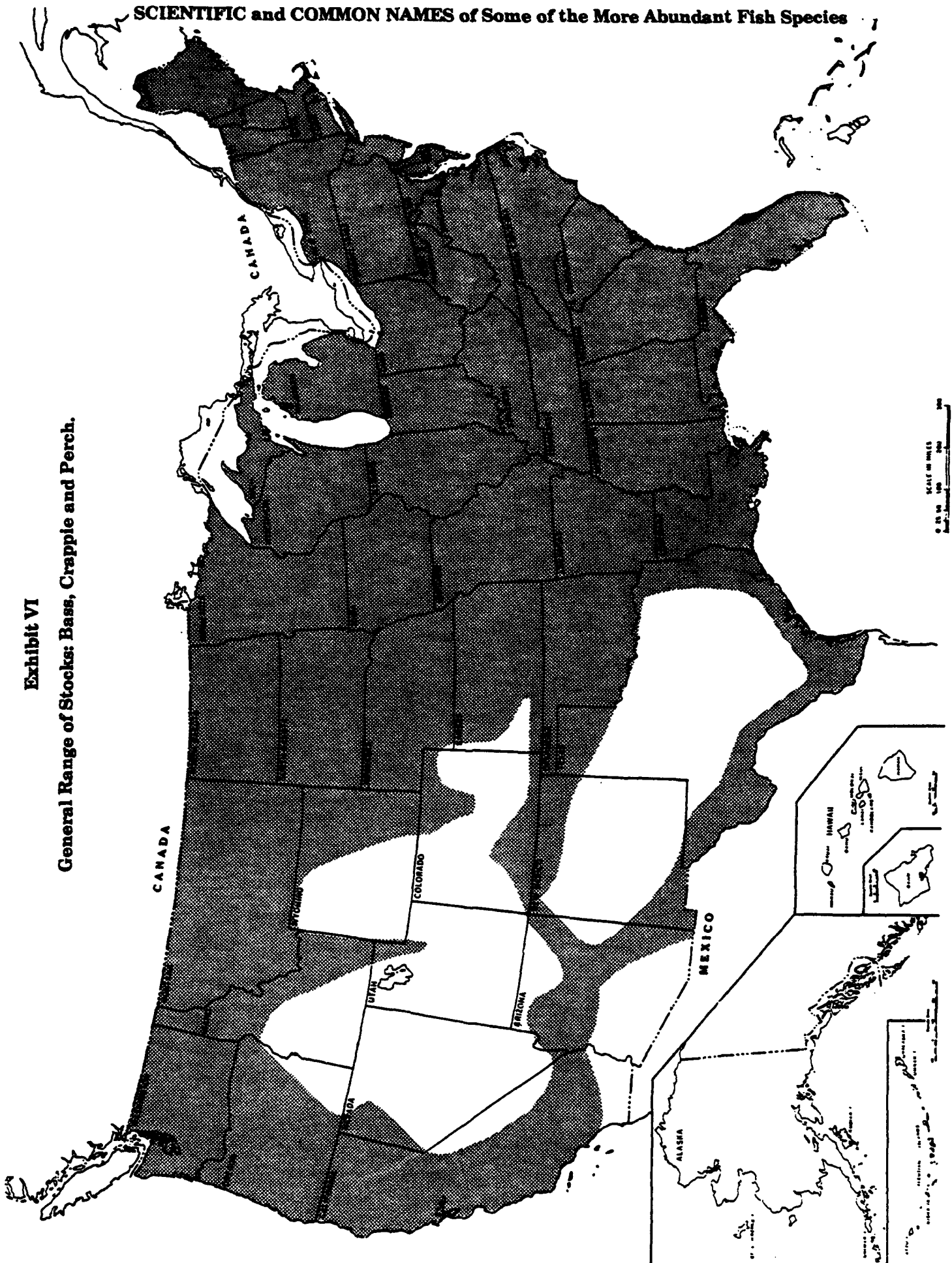

Exhibit VI

General Range of Stocks: Bass, Crappie and Perch.

SCIENTIFIC and COMMON NAMES of Some of the More Abundant Fish Species

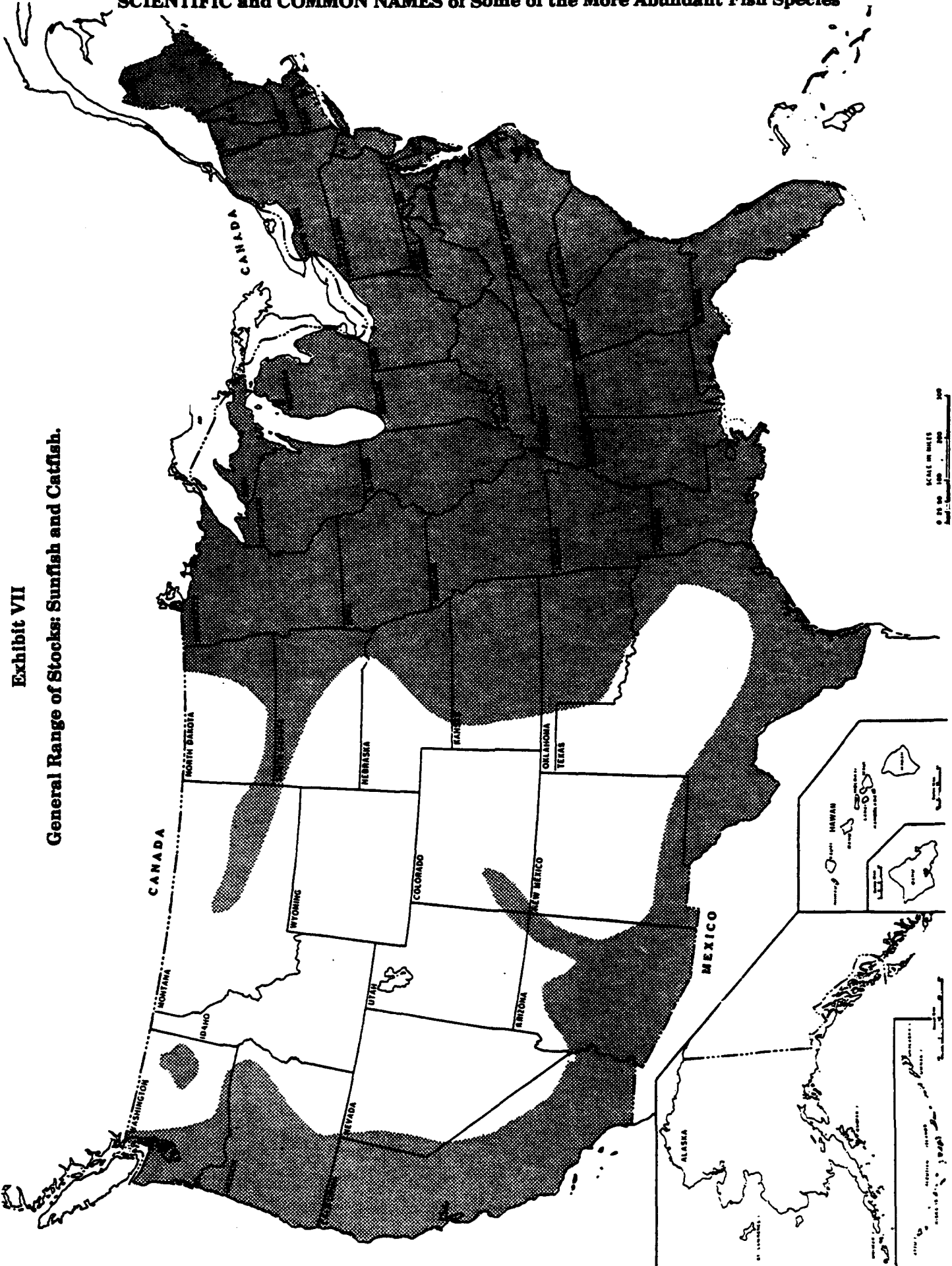
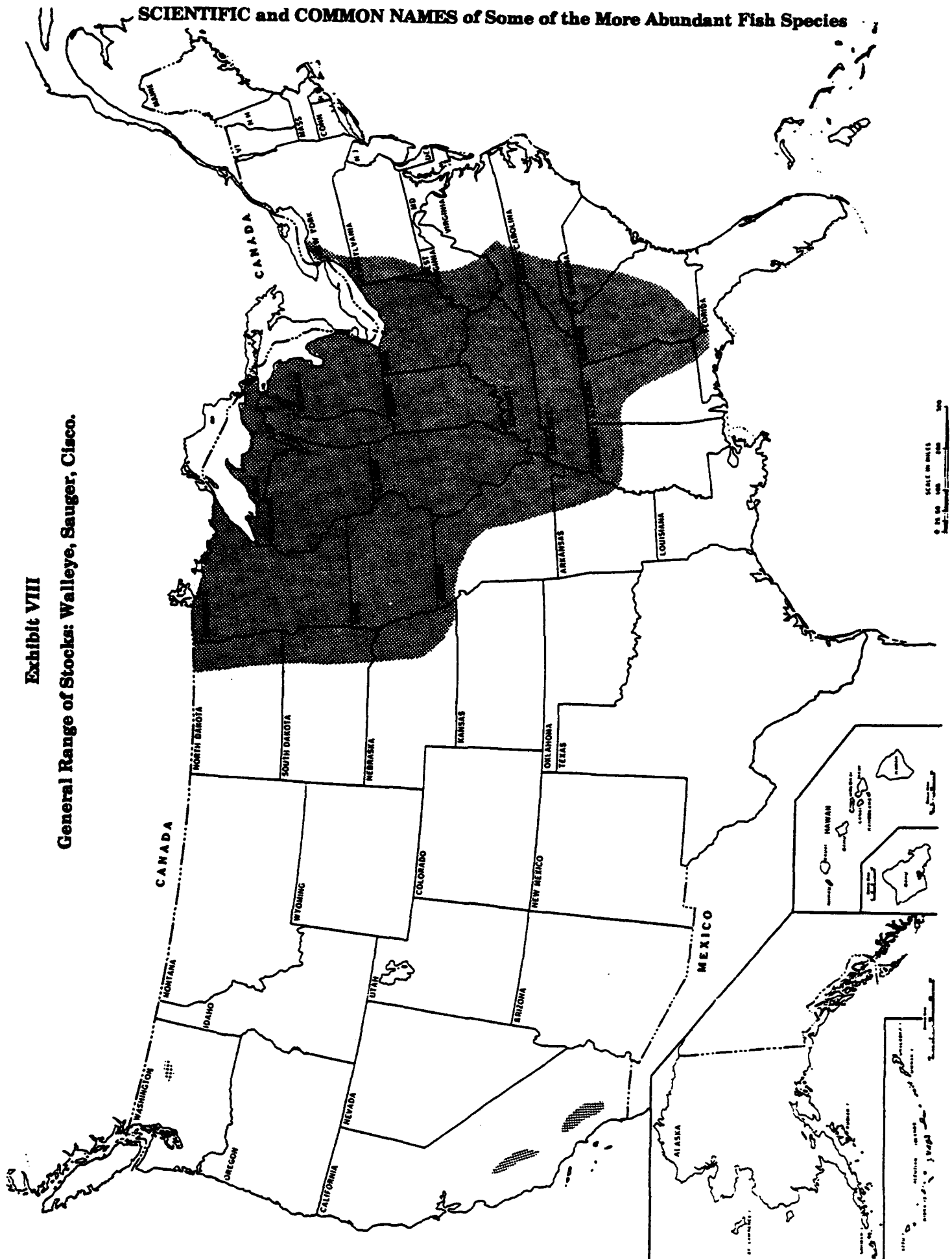

Exhibit VII
General Range of Stocks: Sunfish and Catfish.

SCIENTIFIC and COMMON NAMES of Some of the More Abundant Fish Species

Exhibit VIII
General Range of Stocks: Walleye, Sauger, Cisco.



SCIENTIFIC and COMMON NAMES of Some of the More Abundant Fish Species

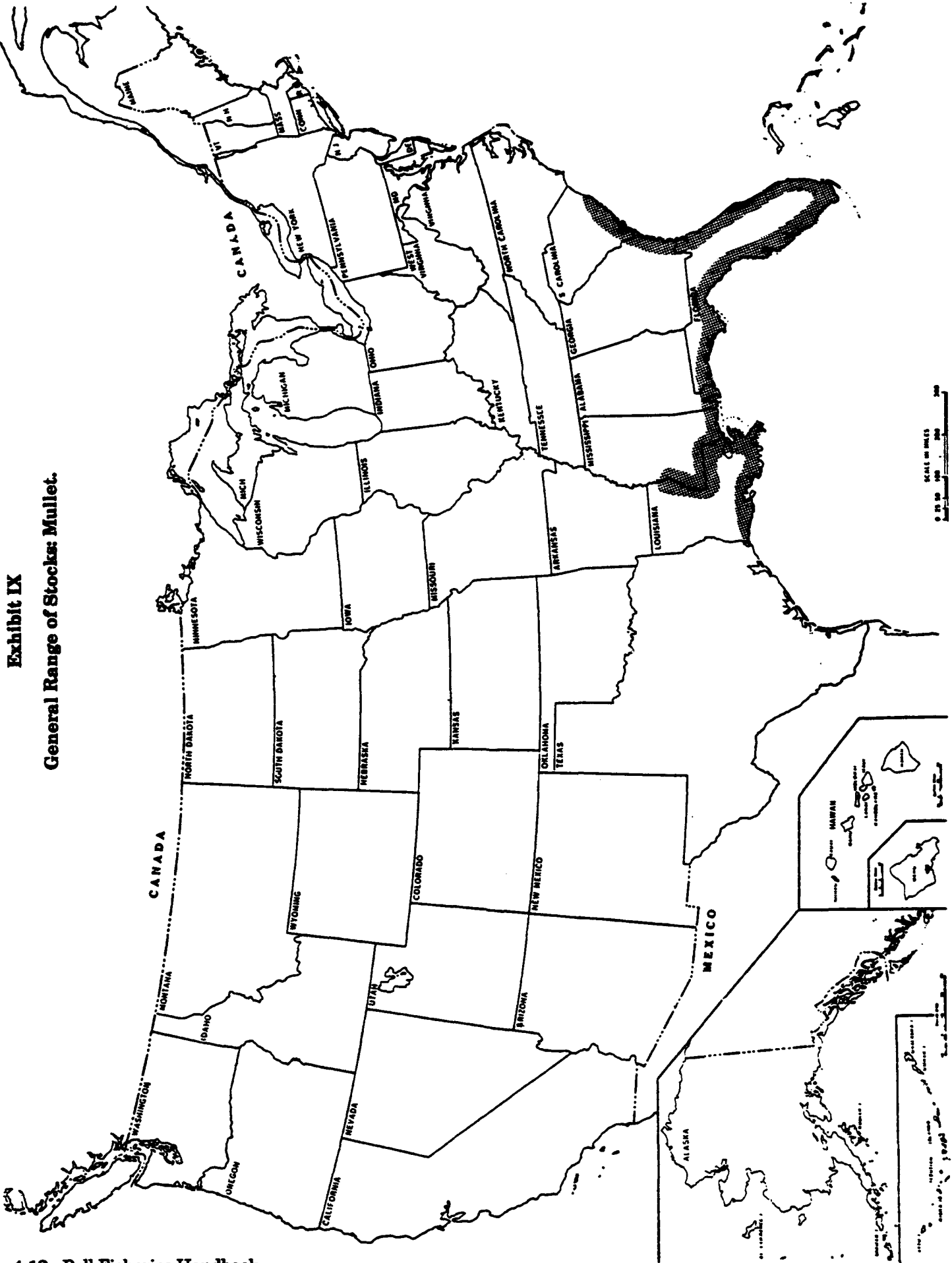

Exhibit IX
General Range of Stocks: Mullet.

Chapter 5

Useful Factors in Life History of Most Common Species

Chinook salmon present in large rivers throughout year.

Sex ratio may be unbalanced.

Returning times of male and females may be different.

Fishing pressure may change sex ratio.

Jacks.

Males live longer and may re-mate.

Occurrence and spawning characteristics of salmonid and related species.

Number of eggs vary.

Hatching time measured in degree days, with number required affected by normal ambient temperatures of region.

Energy requirements for salmonids.

Egg sizes.

Method for determining brood year.

Useful Factors in Life History of Most Common Species in Western United States.

Biological Information on Some Common Species in Continental United States.

A. Pacific Salmon Adults.
Average Length in Inches. Average Weight in Pounds.

B. Length/Weight Relationship for Adults of Major Species in the Study Area.

USEFUL FACTORS in LIFE HISTORY of MOST COMMON SPECIES

In using the tables, it must be recognized that there are variables not shown. The tables are intended to cover only those factors that affect to some degree the design of fish facilities. They do not depict the full range of factors needed for the management of the species.

In large rivers it has been shown that chinook salmon are generally present throughout the year.

In anadromous species the sex ratio of returning fish is assumed to be closely balanced; however, there are known variations. It is not uncommon to find up to 20 percent precocious males in runs in major streams. When considering a specific site, such factors can have an important bearing on the numbers to be handled.

Not infrequently, more normal sized males than females appear in the early part of a run, although the sex ratio may be closely balanced by the end of a season. Early and late segments of runs are subjected to the most adverse natural conditions that may diminish the effectiveness of these spawners. Sex ratios within various streams may be unbalanced by fishing pressure of differential gear efficiencies.

Jacks of the various species are generally considered precocious males that mature one to two years in advance of the normal cyclic time. Occasionally a few early-maturing females have been noted. The cause of precociousness is not fully understood. The literature attributes population pressures and artificial propagation techniques as possible causes.

Under normal spawning conditions the fish are paired, although a male will mate more than once. Males usually outlive females and, in general, can be said to live slightly longer in fresh water than females.

Time for the completion of the spawning act may vary from three to seven days. This is an important item in determining spawning bed sizes.

Redds must not be dried or exposed to stagnant water. Eggs should not be disturbed during the tender period, after they are water hardened and before they are eyed. (See Chapter 7, "Spawning Criteria.")

The number of eggs carried within the females varies with size and species and may not be 100 percent viable. The literature discloses that eggs may be retained and not extruded before death. Not all of the eggs in a skein ripen simultaneously. Fry emerge somewhat in the order of the time of depositing in the redd, accounting for peaks of downstream migration.

Hatching time is a function of temperature: a degree-day is one degree above 32 F. for a 24-hour period. With considerable variation, approximately 900 degree-days are

required for salmon hatching and an equal number for the absorption of the yolk sac, which gives approximately 1,800 degree-days. In contrast to the salmon hatching period, incubation of trout eggs requires approximately 720 degree-days.

Because of the variation, these figures should be used only as an approximation of the length of time that either spend in a spawning bed or a hatching facility.

Although the energy utilization is not thoroughly described, it is useful for comparative purposes. It could be expected in the anadromous stocks, which cease feeding upon entering fresh water, that the male uses over 60 percent of its stored energy for body maintenance and the female uses less than 60 percent at normal temperature levels to time of death. The sex products of the female account for 16 to 18 percent of the body energy, as opposed to 5 to 6 percent in the male. It could be expected that the female uses double the body energy in nest building (3 to 5 percent) as does the male. Therefore, as noted above, the males, living longer, would require more energy for body maintenance.

Egg size is a function of size or age of females. Larger, older females produce larger eggs. Egg sizes given generally refer to green eggs; however, the sizes of water-hardened eggs represent space room required in artificial propagation and are approximated in the tables here, as they vary widely.

Brood years were defined by the Pacific Marine Fisheries Commission in 1957 as follows:

'Brood year' refers to the calendar year in which the bulk of eggs is deposited. Time of egg deposition by a given species is determined by its habits over most of its range in Western North America.

For example:

1. Use as brood year the calendar year of spawning for pink, sockeye, and chinook salmon and for cutthroat and wild rainbow trout.
2. Use as brood year the earlier of the two calendar years of spawning for chum and silver salmon.
3. Use as brood year the later of the two calendar years of spawning for steelhead and fall spawning rainbow trout.

Atlantic salmon are now being introduced in the Great Lakes and, by pen rearing, on the Atlantic and Pacific coasts. See Steelhead, Chapter 5, for approximate life history.

See Chapter 4, "Scientific and Common Names of Some of the More Abundant Fish Species," Exhibits 1 - 9 for general range of species. See also Chapter 21, "Fish Diseases," Chapter 12, "Silt and Turbidity," Chapter 7, "Spawning Criteria," and Chapter 10, "Water Quality."

USEFUL FACTORS in LIFE HISTORY of MOST COMMON SPECIES

Most Common Species in Western United States

Occurrence	Sport, Commercial, Predaceous, Forage, Nuisance	Age at Maturity	Weight (Range)	Av. No. of Eggs (Range)	Time in F.W. (Rearing)	Time in Ocean
Fall Chinook Salmon						
Main Columbia R., Snake R., & tribs.	S,C	3-5 yrs.	15-40 lb. (av. less than 20 lb.)	6,000 (av. size, 11 mm.)	Up to 1 year	2-5 yrs.
Large streams	S,C	3-5 yrs.	15-20 lb.	5,000	Dec.-June	2-5 yrs.
Medium streams	S,C	3-5 yrs.	15-20 lb.	5,000	Dec.-June	2-5 yrs.
Small streams	S,C	3-5 yrs.	15-20 lb.	5,000	Dec.-June	2-5 yrs.
Coastal Wash., medium streams	S,C	3-5 yrs.	15-20 lb.	5,000	3-5 mos.	2-5 yrs.
Coastal Wash., small streams	S,C	3-5 yrs.	15-20 lb.	5,000	3-5 mos.	2-5 yrs.
Sacramento R. (fall)	S,C	4 yrs.	10-50 lb. (av. 20 lb.)	5,000	3 mos.	3+ yrs.
Sacramento R. (winter)	S	4 yrs.	10-30 lb. (av. 15 lb.)	5,000	3 mos.	3+ yrs.
Sacramento R. (spring)	S	4 yrs.	10-30 lb. (av. 15 lb.)	5,000	2 mos. (Aug.-Sept.)	3+ yrs.
Spring Chinook Salmon						
Columbia R., Snake R., and upper tribs.	S,C	4-6 yrs.	10-20 lb. (av. 15 lb.)	5,000 (av. size, 11 mm.)	1 yr. or longer	2-5 yrs.
Large streams	S,C	4-6 yrs.	10-20 lb. (av. 15 lb.)	5,000	Year around	2-5 yrs.
Coastal Wash., medium streams	S,C	4-6 yrs.	10-20 lb. (av. 15 lb.)	5,000	1 yr. + sea-ward migration	2-5 yrs.
Summer Chinook Salmon						
Columbia R. and upper tribs.	S,C	4-6 yrs.	10-30 lb. (av. 14 lb.)	5,000 (av. size, 11 mm.)	1 yr. or longer	2-5 yrs.

USEFUL FACTORS in LIFE HISTORY of MOST COMMON SPECIES

Time of Adult Migration	Preferred Temperature	Spawning Time	Egg Incubation	Downstream Migration	Remarks - Uses or Effects On Other Fish
				(2-3 in.)	Nest builders
Aug.-Dec.	Spawning, egg incub., 50-55 F., Rearing 53.6-57.2 F.	Sept. thru Jan.	Sept.-Mar.	April-June	
Mid July-late Sept.	"	Mid Sept.-late Oct.	Mid Sept.-early Jan.	April-June	
Early Sept.-late Oct.	"	Mid Sept.-late Oct.	Mid Sept.-early Jan.	April-June	
Mid Sept.-late Oct.	"	Late Sept.-late Oct.	Late Sept.-early Jan.	April-June	
Aug. thru Nov.	"	Sept.-mid Dec.	Sept.-Mar.	Jan.-Aug.	
Late Sept.-thru Nov.	"	Oct.-Jan.	Late Sept.-Mar.	Jan.-Aug.	
Sept. thru Nov.	50-55 F.	Oct.-Nov.	Oct.-Dec.	April-early June	
Dec. thru Mar.	50-55 F.	Late Dec.-May	Jan.-June	Oct.-Dec.	
April-May	50-55 F.	June-July	June-Sept.	Nov.-Dec.	
				(3-5 in.)	Nest builders
Jan. thru May	50-55 F.	Late July-late Sept.		During 2nd spring and summer	
Early Apr.-late July	50-55 F.	Early Aug.-early Oct.	Early Oct.-mid Jan.	Mar., July	
March-early June	50-55 F.	Aug.-mid Oct.	Late Aug.-Jan.	During 2nd spring at 5-6 in.	
					Nest builders
June-mid Aug.	50-55 F.	Sept.-mid Nov.		During 2nd spring	

USEFUL FACTORS in LIFE HISTORY of MOST COMMON SPECIES

Most Common Species in Western United States (Continued)

Occurrence	Sport, Commercial, Predaceous, Forage, Nuisance	Age at Maturity	Weight (Range)	Av. No. of Eggs (Range)	Time in F.W. (Rearing)	Time in Ocean
Coho Salmon						
Large streams	S,C	3 yrs.	5-20 lb. (av. 8 lb.)	3,000-4,000 (av. size, 6.6-7.9mm.)	1 yr. + (year around)	2 yrs.
Medium streams	S,C	3 yrs.	5-20 lb. (av. 8 lb.)	"	Year around	2 yrs.
Small streams	S,C	3 yrs.	5-20 lb. (av. 8 lb.)	"	Year around	2 yrs.
Coastal Wash., medium streams	S,C	3 yrs.	5-20 lb. (av. 8 lb.)	"	1 yr. +	2 yrs.
Coastal Wash., small streams	S,C	3 yrs.	5-20 lb. (av. 8 lb.)	"	1 yr. +	2 yrs.
Lower and middle Columbia R. and tribs.	S,C	3 yrs.	5-20 lb. (av. 8 lb.)	"	1 yr. + (year around)	2 yrs.

Note: Small runs appear in June in certain streams.

Pink Salmon

Large streams	C,S	2 yrs.	3-10 lb. (av. 4 lb.)	1,500-2,700 (av. size, 7 mm.)	Mid Jan- late May	1-1/2 yrs.
Medium streams	C,S	2 yrs.	3-10 lb. (av. 4 lb.)	"	Dec.-Mar.	1-1/2 yrs.
Small streams	C,S	2 yrs.	3-10 lb. (av. 4 lb.)	"	Dec.-Mar.	1-1/2 yrs.
B.C. and S.E. Alaska	C	2 yrs.	3-10 lb. (av. 4 lb.)	"	Feb.-May	1-1/2 yrs.

USEFUL FACTORS in LIFE HISTORY of MOST COMMON SPECIES

Time of Adult Migration	Preferred Temperature	Spawning Time	Egg Incubation	Downstream Migration	Remarks - Uses or Effects On Other Fish
				(3.5-4.5 in.)	Nest builders
Early Oct.-late Dec. (peak in Nov.)	Spawning, egg incub., 50-55 F., Rearing 53.6-57.2 F.	Mid Nov.-early Jan.	Mid Nov.-early Mar.	Mar.-July	
Mid Oct.-mid Jan.	"	Mid Nov.-mid Jan.	Mid Nov.-late Mar.	April-June	
Early Nov.-early Jan.	"	Mid Nov.-early Jan.	Mid Nov.-mid Mar.	April-June	
Sept.-Jan. (peaks Oct. and Nov.)	"	Mid Oct.-Mar. (mainly Nov., Dec., Jan.)	Mid Oct.-May	Mar.-July of 2nd year, (peaks in April, May, June)	
Oct.-Jan. (early and late runs)	"	Nov. thru Feb. (peak late Nov.-mid Jan.)	Oct.-May		
Late Aug.-Feb. (peak in Oct.)	"	Sept.-Mar.	Sept.-April	Mar.-July	
				(1-1.5 in.)	Nest builders
Mid July-late Aug.	50-55 F.	Late Aug.-late Oct.	Late Aug.-mid Oct.	Dec.-May	Mainly commercial catch; small sport fishery; runs occur in Puget Sound only in odd-numbered years.
Mid Sept.-late Oct.	50-55 F.	Late Sept.-late Oct.	Late Sept.-early Jan.	Feb.-May	
Mid Sept.-late Oct.	50-55 F.	Late Sept.-late Oct.	Late Sept.-late Jan.	Feb.-May	
Sept.-Oct.	50-55 F.	Late Sept.-late Oct.	Late Sept.-late Feb.	April-May	

USEFUL FACTORS in LIFE HISTORY of MOST COMMON SPECIES

Most Common Species in Western United States (Continued)

Occurrence	Sport, Commercial, Predaceous, Forage, Nuisance	Age at Maturity	Weight (Range)	Av. No. of Eggs (Range)	Time in F.W. (Rearing)	Time in Ocean
Chum Salmon						
Large streams	C	3-4 yrs.	8-12 lb. (av. 10 lb.)	3,000 (av. size, 7-8.7 mm.)	Dec.-May	2-1/2 - 3-1/2 yrs.
Medium streams	C	3-4 yrs.	8-12 lb. (av. 10 lb.)	"	Feb.-May	2-1/2 - 3-1/2 yrs.
Small streams	C	3-4 yrs.	8-12 lb. (av. 10 lb.)	"	Feb.-May	2-1/2 - 3-1/2 yrs.
Coastal Wash., medium streams	C	3-4 yrs.	8-12 lb. (av. 10 lb.)	"	1 mo. +	2-1/2 - 3-1/2 yrs.
Coastal Wash., small streams	C	3-4 yrs.	8-12 lb. (av. 10 lb.)	"	1 mo. (approx.)	2-1/2 - 3-1/2 yrs.
Sockeye Salmon						
Columbia R. to Alaska, in some large streams that provide lake habitat	C	3-5 yrs.	3-8 lb. (av. 6 lb.) larger in Alaska.	3,500 (av. size, 5.5-6 mm.)	1-3 yrs.	1-4 yrs.
Kokanee						
Calif., Oreg., Wash., and B.C. in large, cool lakes and reservoirs	S,F	2-7 yrs. (mostly 3-5 yrs.)	1/8-1 lb. (8-18 in., av. 12 in.)	400-500 for fish 11-12" length	Life	

USEFUL FACTORS in LIFE HISTORY of MOST COMMON SPECIES

Time of Adult Migration	Preferred Temperature	Spawning Time	Egg Incubation	Downstream Migration	Remarks - Uses or Effects On Other Fish
				(1.5-2 in.)	Nest builders
Early Sept.- late Dec.	50-55 F.	Mid Sept.- early Jan.	Mid Sept.- early Mar.	Dec.-May	Runs of chum salmon have declined greatly in recent years throughout the range.
Mid Nov.- mid Dec.	50-55 F.	Early Dec.- mid Jan.	Early Dec.- mid Mar.	Feb.-May	In southern Puget Sound and Hood Canal many medium and small size streams have chum runs with timing similar to pink salmon.
Mid Nov.- mid Jan.	50-55 F.	Early Dec.- mid Jan.	Early Dec.- mid Mar.	Mar.-May	
Oct.-early Dec. (peak in late Oct. and Nov.)	50-55 F.	Mid Oct. thru Dec. (peak in Nov.)	Mid Oct.- Mar.	Feb., Mar. and April	
Mid Oct.- early Nov.	50-55 F.	Late Oct.- mid Dec. (peak in Nov.)	Mid Oct.- Mar.	Feb., Mar., and April	
				(3.5-5 in.)	Nest builders
Some river systems as Fraser and Skeena have 2 peak periods (early runs in late July-early Aug.; late runs in Sept.-Oct.)	50-55 F.	Aug.-Nov.	80-140 days depending on temp.; fry emergence in April-May.	April-June (sea-ward)	Fry enter lakes where they remain one to three years before migrating to the ocean.
					Nest builders
Late July- Dec.	50 F., Spawn at 44-54 F., on falling temp.	Aug.-Jan., depending on water temp. and race of fish. Most spawn in late fall; often 2 strains planted; early run, Aug.-Oct. late run, Oct.-Feb.	Aug.-Feb.	Sept.-Mar.	Formerly limited to lakes with residual sockeye populations; later successfully introduced into many inland lakes and reservoirs; often easily caught; good sport fish, provides forage for large trout in some areas, spawning occurs in tribs. to lakes or around lake shore. Primarily plankton feeders.

USEFUL FACTORS in LIFE HISTORY of MOST COMMON SPECIES

Most Common Species in Western United States (Continued)

Occurrence	Sport, Commercial, Predaceous, Forage, Nuisance	Age at Maturity	Weight (Range)	Av. No. of Eggs (Range)	Time in F.W. (Rearing)	Time in Ocean
Steelhead						
Coastal streams and river systems, northern Calif. to Alaska				Egg sizes vary widely with size of female. (Consider 4-6 mm.)		
Summer Run						
Wash. streams	S	3-6 yrs.	5-30 lb.	5,000	1-3 yrs. (av. 2 yrs.)	1-4 yrs.
Columbia R. "A" Group	S	3-4 yrs.	4-12 lb. (av. 5-6 lb.)	2,500	1-2 yrs.	2-3 yrs.
"B" Group	S and incidental commercial catch.	5-6 yrs.	8-20 lb. (av. 9 lb.)	3,500	1-2 yrs.	3-4 yrs.
Winter Run						
Wash. streams	S	3-6 yrs.	5-28 lb. (av. 8 lb.)	3,500	1-3 yrs. (av. 2 yrs.)	1-4 yrs.
Columbia R.	S and incidental commercial catch	3-6 yrs.	6-20 lb. (av. 8 lb.)	3,500	1-2 yrs. (av. 2 yrs.)	1-4 yrs.
Fall Run						
Sacramento R.	S	2-3 yrs.	1-12 lb. (av. 4 lb.)	1,500	1 yr.	1-2 yrs.
Spring Run						
Columbia R.	S and incidental commercial catch	3-5 yrs.	5-20 lb.	2,500	1-2 yrs.	2-3 yrs.
Rainbow Trout						
Throughout Pacific slope; widely distributed thru hatcheries into other regions; Baja Calif. to Bristol Bay, Alaska, abundant.	S	3-4 yrs.	1/4-42 lb. (av. 1/2 lb.)	1,500 (av. size, 3.1-6.9 mm.)	Life	

USEFUL FACTORS in LIFE HISTORY of MOST COMMON SPECIES

Time of Adult Migration	Preferred Temperature	Spawning Time	Egg Incubation	Downstream Migration	Remarks - Uses or Effects On Other Fish
				(6-8 in.)	Nest builders
April-Nov.	50-55 F.	Feb.-June	Feb.-July	Mar.-June	Sport caught
June-early Aug.	50-55 F.	Feb.-March	Feb.-April	Mar.-June	Mainly sport caught
Aug. thru Oct.	50-55 F.	April-May	April-June	Mar.-June	Sport and commercial catch
Nov.-mid June	50-55 F.	Feb.-June	Feb.-July	Mar.-June	Important sport fishery
Nov. thru May	50-55 F.	Feb. thru May	Feb.-June	Mar.-June	Sport and commercial catch
Early Aug.-Nov.	50-58 F.	Jan.-Mar.	Jan.-April	Next spring as yearlings	Popular sport fishery
Late Feb.-early June	50-55 F.	Late Dec.-Mar.	Late Dec.-May	Spring and summer of following year	Sport and commercial catch
					Nest builders
	50-58 F.	Normally spring; hatchery brood-stocks of fall spawners have been developed.	Normally April-June depending on water temp.		Good sport fish; adaptable to hatchery production and to varied environment, stream spawner; often migrates into lakes for better food supply.

USEFUL FACTORS in LIFE HISTORY of MOST COMMON SPECIES

Most Common Species in Western United States (Continued)

Occurrence	Sport, Commercial, Predaceous, Forage, Nuisance	Age at Maturity	Weight (Range)	Av. No. of Eggs (Range)	Time in F.W. (Rearing)	Time in Ocean
Coastal Cutthroat Trout						
Northern Calif. to Prince William Sound in southeast Alaska	S,P (large fish)	3-4 yrs., sea-run 2-5 yrs.	Resident 1/4-17 lb. sea-run 1/2-4 lb. (av. 1 lb.)	800-1,200	Life or sea-run 1-3 yrs., normal 2 yrs.	Sea-run 1/2-1 yr.
Golden Trout						
Upper Kern R. in Calif.; also hatchery propagated and stocked at high elevations in So. Sierra Nev. mountains.	S	3-4 yrs.	1/4-3 lb. (av. 1/2 lb.)	300-800	Life	
Brown Trout						
Introduced into streams, lakes and reservoirs; Calif. to B.C.	S,P (large fish)	3-4 yrs.	1/4-40 lb. (av. 1-3 lb.)	1,500-2,500 (av. size, 4.05-5.39 mm.)	Life	
Brook Trout (Char)						
Introduced throughout the U.S. west of the Continental Divide; well established in many mountain lakes and streams where it frequently becomes overpopulated and stunted.	S	3-4 yrs.	1/8-5 lb. (av. 1/4-1/2 lb.)	500-2,500 (av. size, 4.1-5.5 mm.)	Life	
Dolly Varden (Char)						
Native to Pacific slope from McCloud R., Calif. to Kamchatka and west to Japan; widely distributed in both lakes and streams. Sea-runs occur in some areas, particularly in B.C. and Alaska with fish of large size.	S,P	4-6 yrs.	1/4-20 lb. (av. 1/2-3 lb.)	1,500-3,500 (av. size, 5-6 mm.)	Life, (sea-run 2-3 yrs.)	Sea-run. Migrate from ocean to lakes each fall.

USEFUL FACTORS in LIFE HISTORY of MOST COMMON SPECIES

Time of Adult Migration	Preferred Temperature	Spawning Time	Egg Incubation	Downstream Migration	Remarks - Uses or Effects On Other Fish
					Nest builders
Sea-run July-Dec.	50 F.	Resident Feb.-May; sea-run Dec.-June	Resident Feb.-June; June, Dec.-July	Sea-run Mar.-June	Native to Pacific slope; spawns in small, cool, well-aerated streams. Mostly wild stock; not easily held for hatchery production.
June-late Aug.	50 F.	June-late Aug.	20 days at 58 F.	None	Occur only in small streams and lakes at high altitudes of Sierra Nevada. Very highly colored. No golden trout eggs shipped from Calif.
					Nest builders
	55-60 F.	Fall and early winter	Sept.-Dec., depending on conditions.		Tolerates warmer water than most trout; the only trout with both black and red spots; cannibalistic; many reach large size; unusually wary and often hard to catch.
					Nest builders
	50-55 F.	Fall	Sept.-Dec., depending on water temp.		Spawns successfully in fall in lakes and streams at higher elevations. Prefers cool water. Has light colored spots against darker body color, dorsal wavy reticulation, white-edged ventral and anal fins, small scales.
					Nest builders
Mid Aug.-early Nov. (ocean to lake)	50-55 F.	Sept.-Nov.	Sept.-Mar. depending on water temp.; Most hatch in Mar., 4-5 mo. after fertilization.	Sea-run spring and early summer, mainly May and June as 4-5 in. smolts	Not highly regarded as sport fish; prefer deep-water lakes; considered predaceous on eggs and young of salmon and trout; long-lived, about 8 years; few spawn more than twice; spawn in parent stream; winter in lakes.

USEFUL FACTORS in LIFE HISTORY of MOST COMMON SPECIES

Most Common Species in Western United States (Continued)

Occurrence	Sport, Commercial, Predaceous, Forage, Nuisance	Age at Maturity	Weight (Range)	Av. No. of Eggs (Range)	Time in F.W. (Rearing)	Time in Ocean
Lake Trout or Mackinaw (Char)						
Introduced from Great Lakes Area into a few large, deep, cold-water lakes of the Pacific slope from Calif. north and in some inland mountain areas. Native to many large lakes in interior B.C. and Alaska.	S,P	4-5 yrs.	1-80 lb. (usually 5-20 lb.)	2,000-6,000	Life	
Arctic Grayling						
North Canada, Alaska and Mont.	S	3-4 yrs.	1.5 lb. (in 7th yr.)	4,000-10,000 (av. size, 3.7 mm.)	Life	
Rocky Mountain Whitefish						
East slope of the Sierra Nevada in Calif. and Nev., west slope of the Continental Divide in mountain streams and lakes of Mont., Idaho, Utah, Oreg., Wash., B.C., including some interior east slope river systems in B.C.	S	3-4 yrs.	1/8-4 lb. (av. 1/2 lb. wt. and 11 in. length)	2,500	Life	
White Sturgeon						
From Monterey Bay, Calif. to Alaska, in major river systems.	S,C	Females, 12-15 yrs.	5-1800 lb., female weighs 40 lb. at 12 yrs. age (av.) and 4 ft. in length.	50,000- 5 million	Varies -some migrate, some remain in F.W.	Varies
Green Sturgeon						
Southern Calif. to Alaska; usually in brackish or salt water in the estuaries or near the ocean entrance of major river systems.	C	12-15 yrs.	5-350 lb.	50,000- 2 million	Seldom in F.W.	Mainly in salt or brackish water

USEFUL FACTORS in LIFE HISTORY of MOST COMMON SPECIES

Time of Adult Migration	Preferred Temperature	Spawning Time	Egg Incubation	Downstream Migration	Remarks - Uses or Effects On Other Fish
	45-50 F.	Fall	Sept.-Mar. depending on water temp.		Nest builders Largest of the charrs; spawn in lakes in rocky ledges without building redd; found in cold, deep water; very predaceous; not easily caught; sport value is chiefly in frequent large size. Hybrid from female lake trout and male brook trout, called "splake" is artificially propagated and stocked in B.C.; long-lived (up to 20 yrs.)
May-June	48 F.	May-June	May-July	June and Sept.- Oct.	Nest builders Slightly adhesive eggs.
	45-50 F.	Fall (Oct.- Nov.) spawn from 42 F. down to 32 F. on falling temp.	Oct. thru March; 5 mo. at 35 F. (hatch mainly in March at 40-42 F.)		Small sucker-like mouth, adipose fin; prefer clear, cold water; mainly a bottom feeder; competes with trout and salmon; eggs released freely -- no nest building; some limited winter sport fishery value.
Downstream in summer and fall; upstream in spring	Mod. to cool water; adaptable to wide temp. range.	Spring and summer	1-2 weeks, depending on temp.	Summer	Small commercial and sport fisheries; roe is valued for caviar; fish are bottom feeders, long-lived, fish over 80 yrs. of age recorded. Mainly a winter fishery.
Slight migration	Ocean temp.	Spring and summer	1-2 weeks	Slight	Smaller than white sturgeon, and of inferior quality as food; less common than the white sturgeon.

USEFUL FACTORS in LIFE HISTORY of MOST COMMON SPECIES

Most Common Species in Western United States (Continued)

Occurrence	Sport, Commercial, Predaceous, Forage, Nuisance	Age at Maturity	Weight (Range) ¹	Av. No. of Eggs (Range)	Time in F.W. (Rearing)	Time in Ocean
Columbia River Smelt (<i>eulachon</i>)						
Northern Calif. to northwest Alaska in some major river systems.	S,C	2-3 yrs.	2 oz (under 12 inches in length at maturity)	25,000 (7,000-60,000)	Slight-drift to ocean soon after hatching.	Usually 3 yrs.
American Shad						
Calif. to Alaska, mainly between the Sacramento R. and Columbia R. In Columbia R. spawning mainly off Washougal reef and from Bonneville to John Day dams.	S,C	Female-6 yrs., Male-5 yrs.	2-6 lb. (av. 3 lb.)	30,000 (25,000-156,000) 2.5-3.5 mm. (skein)	2-3 mos.	5-6 yrs.
Striped Bass						
Exotic sp. spread north from Sacramento R. delta and San Francisco Bay but not numerous north of Umpqua R. Landlocked in some large Calif. reservoirs.	S,P	Female-5 yrs., Male-2 yrs.	1-1/2-80 lb. (av. 8 lb.)	900,000 (9 lb. fish) (av. size, 1.28-1.36 mm) (Swells 2-1/2 times in 12 hrs.)	Varies; some stay in fresh and brackish water; many migrate to ocean in fall at 2 yrs. of age.	Varies, usually less than 1 yr.
Largemouth Bass						
Warmwater lakes and reservoirs, Calif. to B.C.	S,P	1-2 yrs. (9-10 inches).	1/2-10 lb. (av. 2-3 lb.)	5,000-8,000	Life	
Smallmouth Bass						
Scattered warm-water streams, lakes and reservoirs; Calif. to B.C. Not common in northwest.	S,P	2-3 yrs.	1/2-5 lb. (av. 1-2 lb.)	2,000-5,000	Life	
White Bass						
Introduced into Calif. from Mississippi R. drainage; stocked in Nacimiento reservoir.	S,C,P	2-4 yrs.	1/2-3 lb.	200,000-900,000 (av. 500,000)	Life	

USEFUL FACTORS in LIFE HISTORY of MOST COMMON SPECIES

Time of Adult Migration	Preferred Temperature	Spawning Time	Egg Incubation	Downstream Migration	Remarks - Uses or Effects On Other Fish
					Adhesive eggs
Late Dec.-Mar.	45-47 F.	Jan.-Mar.	3 weeks at 47 F.	Feb.-Mar. (fry carried by stream currents to ocean soon after hatching)	Adults die after spawning; spawn in major trib. over fine sand to which eggs adhere. Caught by hand dip-netting; popular sport and food fish during short spawning migration period.
					Demersal eggs
Upstream, Mid May-July (peak in June)	Prefer moderate temp.,	July	3-6 days depending on temp.	Fall	Exotic sp. spread north from Sacramento R.; eggs released freely into water; some repeat spawning but many die after spawning; roe is valued; not an important fresh food fish; some filleted and smoked; good sport fish.
					Demersal eggs
Upstream annually in April-June for spawning	60-65 F.	April-June (peak in May)	60 hrs. at 64 F.	Late summer and fall	Eggs released freely into water and carried by currents during incubation; predaceous on small fish; excellent sport and food fish.
					Nest builders
	70-75 F.	Spring, water temp. above 60 F.	5 days at 66 F., 2 days at 72 F.	No	Important sport fish; very predaceous and cannibalistic.
					Nest builders
	60-70 F.	Spring, water temp. above 60 F.	3-3/4 days at 67 F.; 3-1/2 days at 71 F.; 2-1/2 days at 78 F.	No	Good sport fish in some sluggish streams and impoundments.
Upstream annually April-June	55-60 F.	April-June	20 days at 60 F.	Return to deep water after spawning	Mainly in lakes and large, shallow reservoirs; also thrive in large rivers. Require abundant forage fish, as gizzard or threadfin shad. Female lays demersal adhesive eggs near surface that sink and adhere to rocks and vegetation.

USEFUL FACTORS in LIFE HISTORY of MOST COMMON SPECIES

Most Common Species in Western United States (Continued)

Occurrence	Sport, Commercial, Predaceous, Forage, Nuisance	Age at Maturity	Weight (Range)	Av. No. of Eggs (Range)	Time in F.W. (Rearing)	Time in Ocean
White Crappie						
Warmwater lakes, reservoirs and river sloughs, Calif. to B.C.	S,P N when over-population occurs	2-3 yrs.	1/3-4 lb.	2,000-14,000	Life	
Black Crappie						
Warmwater lakes, reservoirs and river sloughs, Calif. to B.C.	S,P N when over-population occurs.	2-3 yrs.	1/3-4 lb.	20,000-60,000	Life	
Bluegill						
Warmwater ponds, lakes, reservoirs and sluggish streams.	S,F N when over-population occurs.	1 year plus.	1/8-1/2 lb.	3,000 (av. size, 1.04 mm.)	Life	
Pumpkinseed						
Moderately warm ponds, lakes, reservoirs and sluggish streams having abundant aquatic vegetation, Calif. to B.C.	S,F, N when over-population occurs.	1 year plus.	1/8-1/2 lb.	1,500	Life	
Green Sunfish						
Warmwater lakes, reservoirs and sluggish streams, Calif. to Wash.	S,F,P, N when over-population occurs.	1 year plus.	1/8-1/2 lb.	1,500	Life	
Sacramento Perch						
Calif. and Nev., sloughs and sluggish river channels, clear lakes in Calif., Pyramid and Walker Lakes in Nev.	S,P	1-2 yrs.	1/4-3 lb.	84,000	Life	

USEFUL FACTORS in LIFE HISTORY of MOST COMMON SPECIES

Time of Adult Migration	Preferred Temperature	Spawning Time	Egg Incubation	Downstream Migration	Remarks - Uses or Effects On Other Fish
	64-68 F. spawning	Mar.-July			Nest builders Adaptable to turbid water where they predominate over black crappie.
	75 F. growth, 58-64 F. spawning.	Mar.-July			Nest builders Predominate over white crappie in clear waters.
	60-80 F. for growth, above 68 F. for spawning.	April-Sept., peak May-June	32 hrs. at 72-74 F.	No	Nest builders Good forage fish; very prolific; good pond sport fish. Maturity is based on size rather than age.
	60-70 F., above 68 F. for spawning.	April-Sept., peak May-June	3 days at 82 F.		Nest builders Adaptable to cooler water and more aquatic vegetation than bluegill.
	Spawn above 60 F., 60-70 F.	May-Aug., peak in June			Nest builders Adaptable to cooler water than other sunfish; often compete with trout in reservoirs; hybridizes readily with other sunfish.
	71-75 F.	May-Aug.			California native species; no longer abundant due to egg predation by exotic species; not widely distributed; stocking usually not successful; not a nest builder; eggs slightly adhesive.

USEFUL FACTORS in LIFE HISTORY of MOST COMMON SPECIES

Most Common Species in Western United States (Continued)

Occurrence	Sport, Commercial, Predaceous, Forage, Nuisance	Age at Maturity	Weight (Range)	Av. No. of Eggs (Range)	Time in F.W. (Rearing)	Time in Ocean
Channel Catfish						
Warmwater lakes, reservoirs and streams; Calif. to Wash.	S	5-8 yrs.	1/4-13-1/2 lb.	4,000-40,000 (av. size, 3.2 mm.)	Life	
White Catfish						
Warmwater lakes, reservoirs and large streams in Calif.; widely distributed; abundant in Sacramento R., San Joaquin R. delta.	S,C,P	3-4 yrs.	1/4-3-1/2 lb.	2,000-4,000	Life, (fresh to slightly brackish water)	
Yellow Bullhead						
Warmwater lakes, reservoirs and sluggish streams; Colorado R. in Calif., scattered areas in Oreg. and Wash.	S	3 yrs.	1/4-2-1/2 lb.	2,000-12,000	Life	
Brown Bullhead						
Warmwater ponds, lakes, reservoirs and sluggish streams; Calif. to B.C., abundant.	S, N when they overpopulate and become stunted.	3 yrs.	1/4-3 lb.	2,000-12,000	Life	
Black Bullhead						
Warmwater ponds, lakes, reservoirs and sluggish streams; Calif. to B.C.; abundant.	S, N when they overpopulate and become stunted in small lakes and ponds.	3 yrs.	1/4-3 lb.	2,000-12,000	Life	

USEFUL FACTORS in LIFE HISTORY of MOST COMMON SPECIES

Time of Adult Migration	Preferred Temperature	Spawning Time	Egg Incubation	Downstream Migration	Remarks - Uses or Effects On Other Fish
	80 F., Spawn at 70-85 F.	May-July	9-10 days at 60-65 F., 5-6 days at 77 F.		Nest builders Excellent sport and food fish; slow growth and stunting occurs in turbid waters.
	70-75 F., Spawn above 70 F.	June-July	6-7 days at 80 F.		Nest builders Important commercial and sport fish in Calif., prefer clear, open water without dense aquatic vegetation.
	70-75 F., Spawn at 69 F. and above.	Late spring and early summer	5 days at 77 F., 7 days at 69 F.		Nest builders Has rounded caudal fin and white chin barbels; prefers clear water and abundant aquatic vegetation.
	70-80 F., spawn at 69 F. and above.	Late spring and early summer	5 days at 77 F., 7 days at 69 F.		Nest builders Has square tail and dark chin barbels; brown mottled sides, pectoral fins with barbed spine; prefers warm water.
	70-80 F., spawn at 60 F. and above.	April-June	5 days at 77 F., 7 days at 69 F.		Nest builders Has square tail and dark chin barbels; dark brown sides are not mottled, pectoral spines not barbed, body short and stouter than brown bullhead; tolerant to high temperature, turbid water and many pollutants.

USEFUL FACTORS in LIFE HISTORY of MOST COMMON SPECIES

Most Common Species in Western United States (Continued)

Occurrence	Sport, Commercial, Predaceous, Forage, Nuisance	Age at Maturity	Weight (Range)	Av. No. of Eggs (Range)	Time in F.W. (Rearing)	Time in Ocean
Yellow Perch						
Lakes, reservoirs and sluggish streams of moderate temperature; Calif. to B.C.; abundant.	S, N when they overpopulate and become stunted; often compete with trout. Larger fish are pre-daceous.	1-2 yrs.	1/8-3 lb. (av. 1/4 lb.)	5,000-50,000	Life	
Carp						
Lakes, reservoirs, ponds, and sluggish streams of warm to moderate temperature having abundant vegetation and aquatic nutrients; Calif. to B.C., in fresh and brackish water; abundant.	S,C, N when they over-populate.	Male- 1-2 yrs., Female- 1-3 yrs.	1/4-60 lb. (av. 2-6 lb.)	1/2 million- 1 million (av. size, 1.5 mm.)	Life	
Squawfish						
Lakes, reservoirs and coastal streams, Oreg., Wash. and B.C.; Columbia R., Fraser R. and Skeena R. systems; in warm to moderate water temperature.	P,N	5-6 yrs.	1/4-5 lb.	5,000-20,000	Life	
Chiselmouth						
Lakes, reservoirs and streams of moderate temperature in the Columbia and Fraser R. systems and eastern Oreg.	N				Life	

USEFUL FACTORS in LIFE HISTORY of MOST COMMON SPECIES

Time of Adult Migration	Preferred Temperature	Spawning Time	Egg Incubation	Downstream Migration	Remarks - Uses or Effects On Other Fish
	50-60 F., spawn at 45-55 F.	Early spring	3-4 weeks at 45-55 F.		Adhesive eggs Adaptable to a wide range of water temperature; may limit trout population in some areas; easily caught.
	68 F., spawn at 60-68 F.	Spring and summer	4 days at 71 F.		Adhesive eggs Adaptable to a wide temperature range and to turbid, polluted, and waters of low dissolved oxygen; fast-growing in fertile waters; mainly vegetarian; destroy aquatic vegetation and degrade aquatic environment.
	60-70 F.	May-June	7 days at 65 F.		Extremely predaceous on young salmonids; high rate of reproduction; competes for food and space with desirable species. A closely related species occurs in Calif.
					Mainly vegetarian; competes for space and food with desirable species; a fine scaled minnow; mouth on ventral side of horny-plated head; av. size 9-10 inches.

USEFUL FACTORS in LIFE HISTORY of MOST COMMON SPECIES

Most Common Species in Western United States (Continued)

Occurrence	Sport, Commercial, Predaceous, Forage, Nuisance	Age at Maturity	Weight (Range)	Av. No. of Eggs (Range)	Time in F.W. (Rearing)	Time in Ocean
Columbia River Chub or Peamouth						
Lakes, reservoirs and coastal rivers of Oreg., Wash. and B.C., abundant.	P,N				Life	
Roach or Tui Chub						
Lakes and reservoirs of Columbia, Klamath and Sacramento R. systems, eastern Sierra Mts. in Calif. and Nev.; abundant.	F,N when they over- populate.	2-3 yrs.	1/8-1/2 lb.	5,000-15,000	Life	
Largescale Sucker						
Lakes, reservoirs and streams of the coasts of Oreg., Wash. and B.C.; abundant.	N when over- population occurs.	Male-5 yrs., Female- 6 yrs.	1/4-5 lb. (av. 1-2 lb.)	10,000- 20,000	Life	
Bridgelip or Columbia Small- Scaled Sucker						
Klamath, Columbia and Fraser R. systems, usually in running water; abundant.	N when over- population occurs.	5-6 yrs.	1/4-5 lb. (av. 1-2 lb.)	10,000- 20,000	Life	

USEFUL FACTORS in LIFE HISTORY of MOST COMMON SPECIES

Time of Adult Migration	Preferred Temperature	Spawning Time	Egg Incubation	Downstream Migration	Remarks - Uses or Effects On Other Fish
		May-June			Will tolerate saltwater; tail deeply forked, small barbel at corner of small mouth; competes for food and space with salmonids; predaceous on salmon eggs; spawn in both lakes and streams.
	Spawn at 55-60 F.	Spring			Several sub-species; slow growing; very prolific; often eliminate trout by competition and overcrowding; provide forage for bass and trout for 2 years.
	50-60 F.	April-May	2 weeks at 55 F.		Very prolific; compete for food and overcrowd desirable species.
	50-60 F.	Late spring			Competes with more desirable species.

USEFUL FACTORS in LIFE HISTORY of MOST COMMON SPECIES

Most Common Species in Western United States (Continued)

Occurrence	Sport, Commercial, Predaceous, Forage, Nuisance	Age at Maturity	Weight (Range)	Av. No. of Eggs (Range)	Time in F.W. (Rearing)	Time in Ocean
Redside Shiner						
Sluggish coastal streams, ponds, lakes and reservoirs in Calif., Oreg., Wash. and B.C.; abundant.	F, N when over-population occurs.	2-3 yrs.	1-3 oz.		Life	
Dace						
Small streams and along shore areas of lakes and reservoirs, widely distributed from Mexico to Alaska, coastal and inland, over a wide range of water temperatures; mainly bottom dwellers, usually with rock cover.	F		All small, 1/4-2 oz.	Few	Life	

USEFUL FACTORS in LIFE HISTORY of MOST COMMON SPECIES

Time of Adult Migration	Preferred Temperature	Spawning Time	Egg Incubation	Downstream Migration	Remarks - Uses or Effects On Other Fish
-------------------------	-----------------------	---------------	----------------	----------------------	---

50-60 F.

May-Aug.

Very prolific; their forage value usually is more than offset by harmful effects of overcrowding and competition with young salmonids for food.

Wide range, spawn at 53 F.

Spring-early summer

Several species; small (under 6 inches) minnows; may compete with fingerling salmonids for food; solitary (non-schooling), not an important forage fish.

USEFUL FACTORS in LIFE HISTORY of MOST COMMON SPECIES

Biological Information on Species in Continental United States

Fish Species (Common and Scientific Names)	Spawning and Egg Incubation	Size and Number of Eggs	Larvae Size	Other Pertinent Information
Gizzard shad <i>Dorosoma cepedianum</i>	Spawning occurs at temperatures of 63 to 73 F. (17-23 C.) in spring or early summer over a variety of substrates ranging from boulders and gravel to beds of silt and sand. Eggs hatch in 95 hours at 62 F. (16.7 C.) or in approx. 36 hours at 80 F. (26.7 C.).	Diameters of mature eggs in ovaries range from 0.45 to 0.55 mm. Fertilized eggs after fixation were 0.75 mm. Fecundity ranges from 22,405 to 543,912, averaging 379,000 eggs.	Average hatching length of yolk sac larvae is 3.25 mm, with body depth estimated at 0.2 mm. Larvae body shape is long and slender (10.8 mm TL).	Eggs, although demersal, often drift with the current. As they are adhesive, they attach themselves to any object they contact. After the 20-mm stage of growth, the gizzard shad's shape begins to change to the adult form. It is one of the few native species that can subsist solely on vegetative material.
Paddlefish <i>Polydon syathula</i>	Upstream spawning migration starts when water temperature reaches 50 F. (10 C.), river is lowering and currents are weakening. Spawning occurs over large gravel bars in rapidly-flowing water. Eggs hatch in 7 days or less at 62.5-70 F. (18-21 C.).	Fertilized egg diameters range from 2.7 to 4.0 mm, averaging 3.0 mm. Average fecundity determined from spawning two fish was 35,000.	Median fry lengths range from 8.0 to 9.5 mm, averaging 8.2 mm.	Unfertilized eggs are nonadhesive. Fertilized eggs form a sticky coating, causing them to adhere to anything with which they come in contact. Sac larvae exhibit continuous erratic swimming, from bottom to surface.
Longnose gar <i>Lepisosteus osseus</i>	Spawning occurs in shallow waters of lake and large streams (over vegetation) in late spring or early summer. There is evidence of upstream spawning migrations during spring freshets. Group spawning believed to take place. Six to 8 days for egg incubation.	Egg diameters range from 2.1 to 3.2 mm. Fecundity for 30.2 to 53.9-inch (76.7-137.0 mm) females was 4,273 to 59,422, with an average of 27,830.	Approx. 8 mm.	Eggs are adhesive and scattered randomly at spawning, becoming attached to vegetation. Sac fry can swim but are relatively inactive, hanging vertically for long periods, attached by their adhesive structure to objects in the water. Yolk sac is absorbed in 7 days. Young grow rapidly, possibly six times as fast as young of other North American freshwater species.

USEFUL FACTORS in LIFE HISTORY of MOST COMMON SPECIES

Biological Information on Species in Continental United States (Continued)

Fish Species (Common and Scientific Names)	Spawning and Egg Incubation	Size and Number of Eggs	Larvae Size	Other Pertinent Information
Rainbow smelt <i>Osmerus mordax</i>	Spawning migration to rivers and streams begins in spring. Eggs hatch in 2-3 weeks, depending on temperature.	Average egg diameter was 0.9 to 1.0 mm. Fecundity for 5.0- to 8.2-inch (127-209 mm) females ranged from 8,500 to 69,000 (demersal and adhesive).	5 mm long at hatching.	Some live their entire lives in freshwater lakes, but normally are anadromous, returning to freshwater rivers to spawn. They are sensitive to light and are often found along the bottom during daylight.
Silvery minnow <i>Hybognathus nuchalis</i>	Spawning occurs in late April to early May when water temperatures are 55.4-68.9 F. (13.0-20.5 C.). Fish spawn in daylight, broadcasting the eggs over decaying vegetation in water 2-6 inches deep.	Egg diameter is 1.10 mm. Fecundity ranged from 2,000 in a 2-1/2 inch (60 mm) female to 6,600 in a 3-1/2 inch (90 mm) female.	Newly-hatched larvae are 6 mm in length.	Prior to spawning, adults migrate from the lakes or rivers to slow-moving, lower reaches of tributary streams or well-vegetated lagoons. Eggs are nonadhesive. Yolk sac larvae stay near the bottom while larvae rise to the surface and concentrate in small schools usually among emergent vegetation.
Bridle shiner <i>Notropis bifrenatus</i>	Spawning occurs from late May to mid-July in New Hampshire and from early May to August in New York State.	Diameters of eggs range from 0.8 mm-1.5 mm.	Yolk sac larvae length is 4.2 mm.	Eggs in ovary mature progressively during the spawning period. This is considered an excellent forage fish because of its small size and relatively weak swimming ability.
Spottail shiner <i>Notropis hudsonius</i>	Spawning occurs inshore during the spring and early summer. In Lake Erie, fish spawn at depths of 3-4 feet.	Average egg diameter is 0.8 mm. Fecundity of yearlings ranged from 100-1,400 eggs and of 2-year-olds ranged from 1,300-2,600 eggs (demersal).	Putative yolk sac larvae is 5 mm in length.	Often the most abundant minnow or northern lakes.

USEFUL FACTORS in LIFE HISTORY of MOST COMMON SPECIES

Biological Information on Species in Continental United States (Continued)

Fish Species (Common and Scientific Names)	Spawning and Egg Incubation	Size and Number of Eggs	Larvae Size	Other Pertinent Information
Bigmouth buffalo <i>Ictiobus cyprinellus</i>	Spawning occurs from mid-May to early June and peaks at water temperatures of 60-65 F. (15.5-18.3 C.). Fish move out of lakes and large rivers to spawn in small tributaries, marshes or flooded lake margins. Spring freshets and flooding seem to be necessary to initiate spawning activity. Eggs hatch in approx. 2 weeks.	Diameters of preserved eggs ranged from 1.2-1.8 mm. Fecundity of 26.2-inch (665 mm) female was 750,000.		Eggs are adhesive and attach themselves to vegetation after being scattered at spawning.
Pygmy whitefish <i>Prosopium coulteri</i>	Spawning is assumed to take place in shallow water of streams or lakes during late fall through early winter.	In Naknek River, Alaska, diameter of mature eggs in the ovaries was 2.4 mm, and 2.0 mm in Lake Superior. A 5.1-inch (130 mm) female in Lake Superior averaged 440 eggs while same-sized female from Naknek River averaged 580 eggs.		
Threespine stickleback <i>Gasterosteus aculeatus</i>	Spawning generally occurs in June or July, but breeding continues throughout the summer (April-September, inclusive). Male constructs a nest of twigs and other debris on the bottom, usually in a sandy, shallow area. Females lay from 50-200 eggs during spawning, but often spawn more than once in a season. Hatching occurs in 7 days at 66.2 F. (19 C.).	Egg diameters range from 1.5-1.7 mm.	Newly-hatched larvae are 4.2-4.5 mm long.	Nearly circumpolar in distribution. The barrel-shaped, hollow nest is held together by a mucilaginous kidney secretion. Eggs are adhesive and are laid in small clusters inside the nest.

USEFUL FACTORS in LIFE HISTORY of MOST COMMON SPECIES

Biological Information on Species in Continental United States (Continued)

Fish Species (Common and Scientific Names)	Spawning and Egg Incubation	Size and Number of Eggs	Larvae Size	Other Pertinent Information
Northern pike <i>Esox lucius</i>	Spawning occurs in the spring as soon as the ice melts when water temperatures are 40-52 F. (4.4-11 C.). Spawning generally occurs during daylight over weedy marshes, floodplains of rivers and bays of larger lakes. Eggs usually hatch in 12-14 days. At 64-68 F. (17.8-20 C.) eggs hatched in 4-5 days.	Egg diameters range from 2.5-3.0 mm. Average fecundity is 32,000 eggs.	6-8 mm long at hatching.	Pike occur throughout the northern hemisphere. Eggs are demersal and initially adhesive, forming clumps that break apart in 5 days. Newly-hatched fry attach to vegetation by adhesive glands for 6-10 days, subsisting on yolk material. Growth is rapid in young; 1-month fish are 1-3/4 inches (43 mm) and are 6 inches (152 mm) by the end of summer.
Alewife <i>Alosa Psuedoharengus</i>	Time of spawning ranges from April to mid-July. Spawning occurs in lakes or streams above the influence of salt water, at night and over sandy or gravelly bottoms in pairs or groups of three. Eggs hatch in 6 days at 60 F. (15.6 C.) or in 3 days at 72 F. (22.2 C.).	Average diameter of unfertilized eggs is 0.9 mm. Freshwater female's fecundity ranges from 10,000 to 12,000. Salt water female's fecundity ranges from 60,000 to 100,000.		Adults are noted to negotiate rapids and fishways better than American shad and to migrate further upstream. Alewives move inshore at night and offshore during daylight hours. Eggs are broadcast at random, are demersal and are essentially non-adhesive. Adults move to deep water after spawning where they remain throughout winter. Annual mortality in the Great Lakes is probably caused by fish's inability to adjust to rapidly-changing temperatures.
Muskellunge <i>Esox masquinongy</i>	Spawning occurs in April-May when water temperatures are 49-59 F. (9.4-14 C.) with optimum of 55 F. (12.8 C.) during the day in weedy, flooded areas in water 15-20 inches deep. Eggs hatch in 8-14 days at temperatures of 53-63 F. (11.7-17.2 C.).	Diameters of fertilized eggs range from 2.5-3.5 mm. Fecundity ranges from 6,000 to 265,000 averaging 120,000.	9.5-10.3 mm long at hatching.	Young reach 6 inches (152 mm) in 10 weeks and are 10-12 inches (254-305 mm) by November of their first year.

USEFUL FACTORS in LIFE HISTORY of MOST COMMON SPECIES
Biological Information on Species in Continental United States (Continued)

Fish Species (Common and Scientific Names)	Spawning and Egg Incubation	Size and Number of Eggs	Larvae Size	Other Pertinent Information
Utah chub <i>Gila atraria</i>	Spawning occurs mainly during late June or July in Montana when water temperatures are above 53 F. (12 C.). Spawning occurs in 2 feet (60 cm) of water over various bottom types, but most eggs were recovered from sand and gravel bottoms. Eggs hatch within 2 weeks.	Egg size is 1.04-1.17 mm. Average fecundity is 40,750.	1.69-2.67 mm long.	Eggs are adhesive and demersal.
Cisco <i>Coregonus artedii</i>	Spawn in the winter at temperatures at approx. 39.0-41.0 F. (4.0-5.0 C.) with a peak number of fish spawning at 37.9 F. (3.3 C.). In inland lakes, fish spawn over almost any kind of substrate, but often over a gravel or stony substrate in shallow water, 3-10 feet deep. In the Great Lakes, spawning may occur in shallow water, at midwater depths of 30-40 feet below the surface and near the bottom in the water 210 feet deep. Hatching occurs at spring ice breakup, 92 days incubation at 42 F. (5.6 C.), 106 days at 41 F. (5 C.)	Fecundity ranges from 6,000 to 29,000. Egg diameter ranges from 1.8-2.1 mm (eggs taken from the body cavities of partly-spent Lake Erie females).		
Golden redhorse <i>Moxostoma erythrurum</i>	Spawning occurs over riffles in the main stream of a river in springtime when waters reach 59-60 F. (15-15.5 C.). Eggs are broadcast over the stream bottom.	Diameters of mature eggs from ovaries were 2.2-2.6 mm, with an average diameter of 2.4 mm. 11.5-15.7-inch (292-399 mm) females average egg number ranged from 6,100-25,350, with estimates to 35,000.		

USEFUL FACTORS in LIFE HISTORY of MOST COMMON SPECIES

A Pacific Salmon Adults Average Length in Inches Average Weight in Pounds

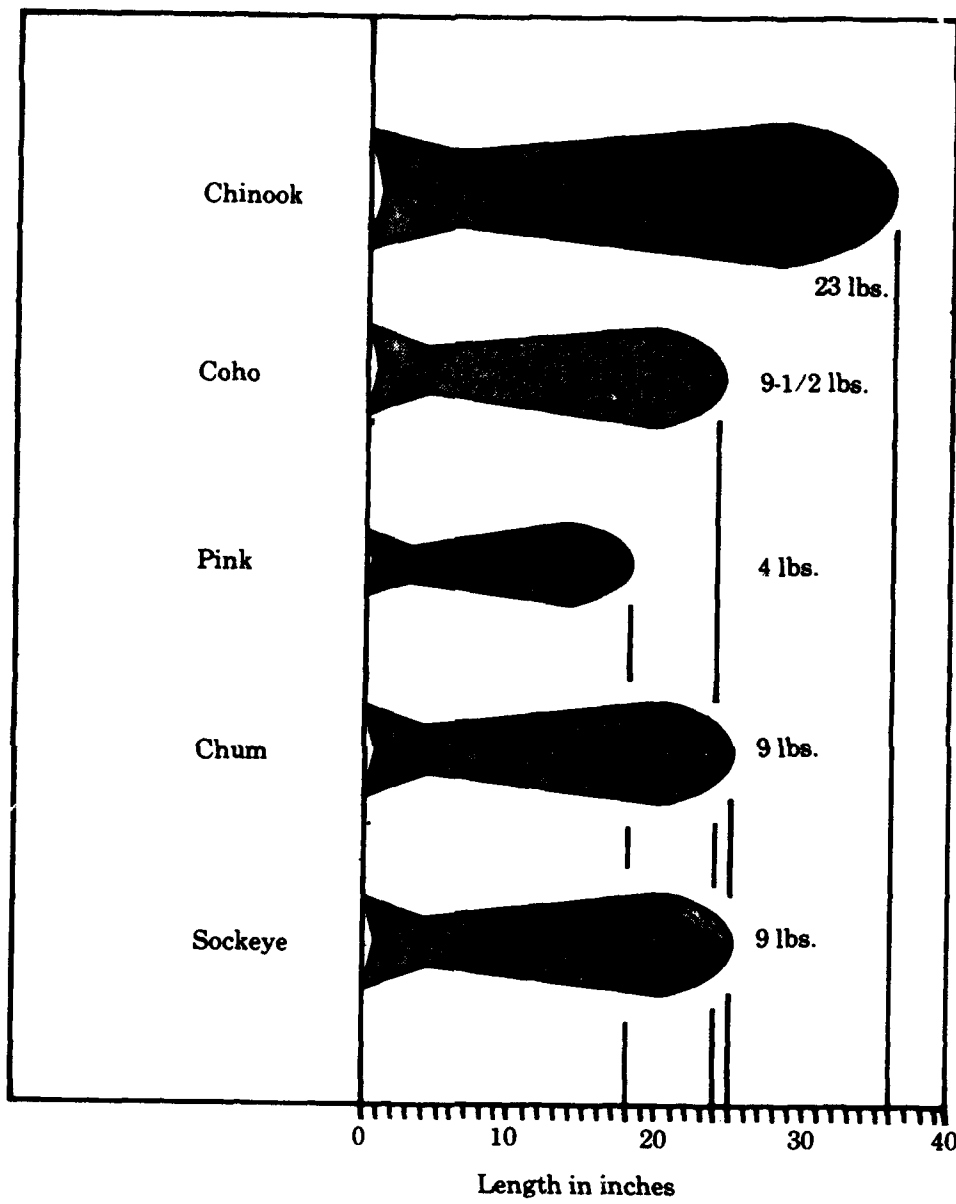

USEFUL FACTORS in LIFE HISTORY of MOST COMMON SPECIES

B
Length/Weight Relationship
 for Adults of Major species in the Study Area

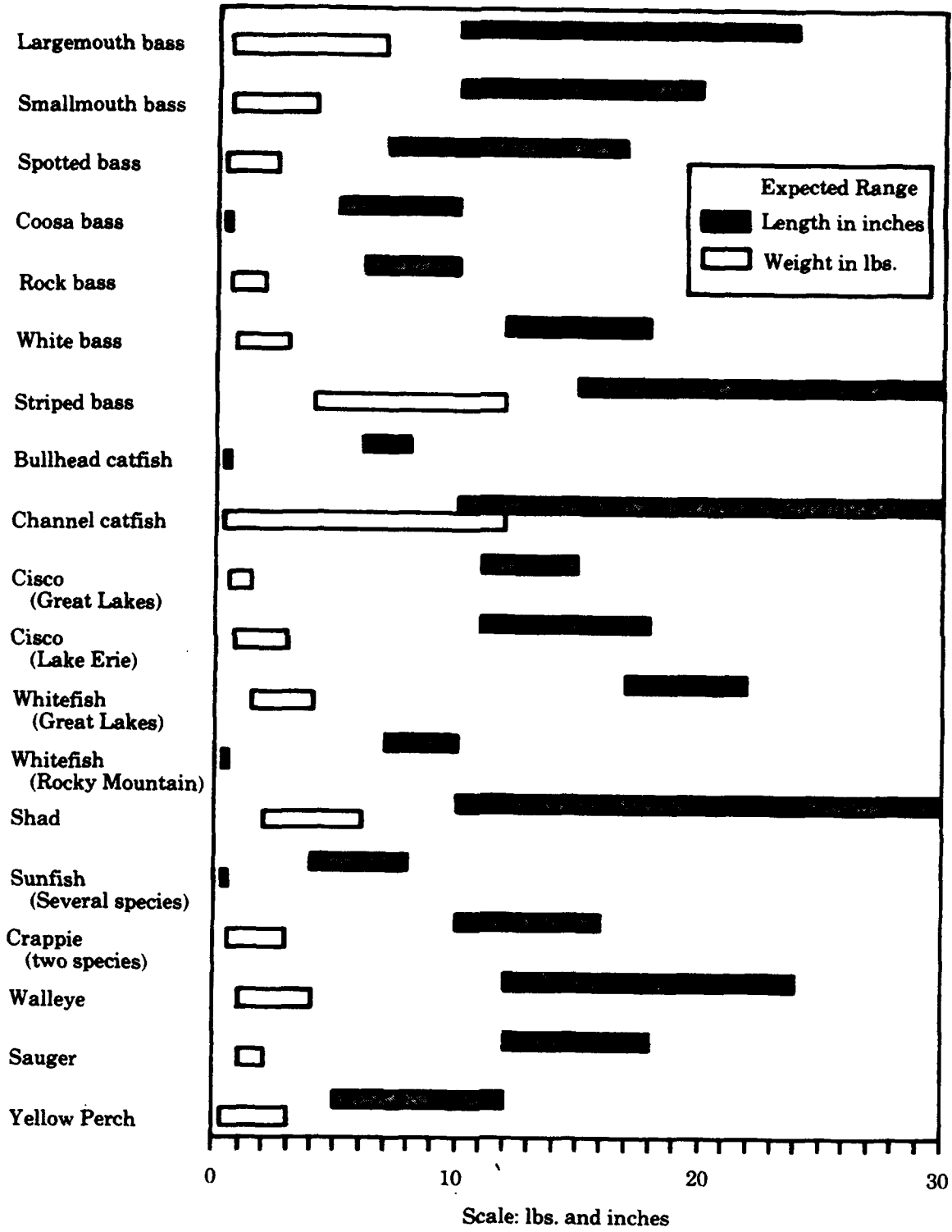

Chapter 6

Swimming Speeds of Adult and Juvenile Fish

Importance of cruising, sustained and darting swimming speeds to fish facility structures.

Amount of energy loss in transfer of muscular energy to propulsion.

Forces working against fish movement.

Effects of exhaustive exercise.

Ratio of sustained speed to darting speed and cruising speed to darting speed.

Attractive velocities at obstructions and fishways.

Effects of velocity gradients.

Method of determining the time fish can maintain various speeds.

Velocities to be used in designing upstream facilities.

Pulsing velocities and turbulence effects.

Swimming speeds affected by oxygen and other functions of fish.

Effect of temperature on swimming effort.

Visual reference and effect of darkness and light.

Pollution effects.

A. Relative Swimming Speeds of Adult Fish.

B. Relative Swimming Speeds of Young Fish.

C. Relative Swimming Speeds (Mackenzie River and Alaska data).

D. Swimming Speed of Sockeye Fry at Chilko Lake.

E. Maximum Sustained Cruising of Sockeye and Coho Underyearlings in Relation to Temperature.

References Reviewed.

SWIMMING SPEEDS OF ADULT AND JUVENILE FISH

In the development of fish facility structures, three aspects of swimming speeds are of concern.

1. Cruising - a speed that can be maintained for long periods of time (hours).
2. Sustained - a speed that can be maintained for minutes.
3. Darting - a single effort, not sustainable.

Exhibit A and B show the relative swimming speeds of selected adult and juvenile species. Exhibit C shows swimming speeds for MacKenzie River fish. Exhibit D shows the swimming effort of sockeye salmon fry at Chilko Lake.

Fish normally employ cruising speed for movement (as in migration), sustained speed for passage through difficult areas, and darting speed for feeding or escape purposes. Each speed requires a different level of muscular energy, and it may be assumed that there is a 15 per cent loss in the transfer of muscular energy to propulsion.

The force on the fish may be considered equivalent to that associated with any object, either moving within water or stationary in moving water. Energy involved may be computed by the following equation.

$$F = C_d A W \frac{V^2}{2g}$$

where F = force (in pounds)

C_d = drag coefficient = .2 (salmon)

Area = cross sectional area in square feet

W = weight of water (62.4 pounds per cubic foot)

V = summation of velocities in feet per second

g = gravity (32.2 feet per second per second)

Thus, force through a distance gives foot-pounds and can be converted to British thermal units or calories.

As energy requirements are related to the square of the apparent velocity, the reason why fish tire rapidly as the velocity increases is evident from the above formula. The build-up of lactic acid as a result of unusual activity can be fatal. A number of investigators have indicated that fish may recuperate rapidly after exhaustive exercise. Conversely, it has been noted that up to 2 hours are required for fish to recover and assume normal movement after tiring exercise.

An early investigator (Reference No. 36) used the weight of the fish to establish a ratio of sustained speed to darting speed of approximately .5 to .7. This has been borne out by recent investigations in which lengths of fish were used as a measure.

The data indicate that a fish's cruising speed level may be 15 to 20 per cent of its darting speed level. This is further supported by data from experiments on jumping fish by computing the velocities at which the fish leave the surface by using the following formula and comparing the results with the results of the swimming tests.

$$V = \sqrt{2gh}$$

where V = initial velocity in feet per second (at water surface)

g = gravity (32.2 feet per second per second)

h = height in feet of jump above water surface

Investigations have shown that fish are able to sense low levels of velocity and may orient themselves to a velocity of 0.16 fps and may sense changes of 0.328 fps (Reference 48). They, hence, may seek and find the most favorable areas, which makes it difficult to use average velocities in determining the effects of swimming speeds. It is suggested that normal distribution curves be utilized for this purpose.

Adults frequently seek higher velocities at obstructions, which may be utilized to attract them to fishway entrances. Such velocities should be well under the darting speed of the species and sizes involved but may exceed their cruising speed.

Swimming speeds are affected by available oxygen and swimming effort may be reduced by 60 per cent at oxygen levels of one-third saturation. Oxygen levels also affect other functions of fish.

Temperatures at either end of the optimum range for any species affects swimming effort. A graphic presentation (Exhibit E) has been prepared from Reference 16 and shows that a reduction of swimming effort of 50 per cent may occur as a result of adverse temperatures.

In dealing with problems at specific sites where swimming speed is important, such as the protection of juveniles ahead of protective screening or the guidance of fish (both adult and juvenile), the effects of temperature and oxygen must be evaluated.

As fish sense changes in velocity, they may avoid moving from one gradient to another, particularly from a lower to a higher gradient. When guiding or directing fish, smooth transitions and accelerations are desirable in order to prevent them from stopping, hesitating or refusing to enter a particular area.

It is assumed that fish use visual references in their movement and, therefore, behave differently in darkness than in light. Stimuli other than velocity may guide the fish's movement within established levels of cruising and sustained speed. Downstream migrating fish may lock into a velocity and be swept along at speeds that are well in excess of their cruising speeds.

In a series of tests (Reference 49) it was shown that fish tested passed through an endless pipe system more rapidly when the system was lighted. With opposing velocities of 2 to 2.5 fps, the best swimming performance was obtained.

An increase of 23 per cent in passage time was found when the system was in darkness, and the maximum distance attained by the sockeye tested was about 1 mile under light and 0.26 mile under darkness. The ground speed of the fish was under 2 fps.

In the design of upstream facilities, velocities must be kept well below the darting speeds for general passage.

SWIMMING SPEEDS OF ADULT AND JUVENILE FISH

A means of determining the time that fish are capable of maintaining various speeds is given below:

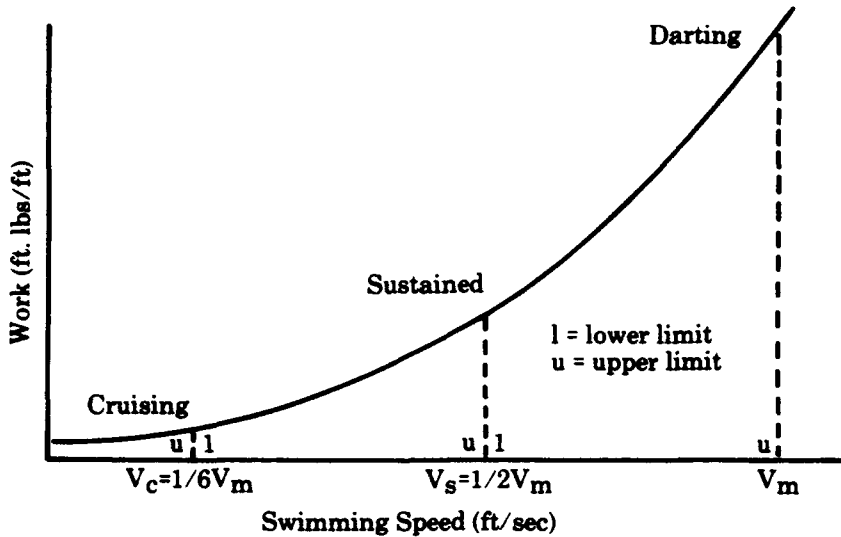

$$k = \frac{C_d A 62.4 \text{ lbs.}}{2g} \quad \text{assuming } C_d \text{ does not vary throughout the swimming ranges.}$$

A = Cross sectional area in square feet.

V_m = Maximum swimming velocity in feet per second.

D (Swimming Distance) = VT

Work = kV^2D or kV^3T

The maximum time that darting can be maintained is estimated at 5 to 10 seconds, thus the time that maximum sustained speeds can be maintained is shown by the relationship

$$kV_s^3T_s = kV_m^3T_m$$

where $kV_m^3T_m$ = maximum energy factor at optimum temperature.

Velocities should not be averaged as the energy factor varies with the square of instantaneous velocity. Pulsing velocities can increase the instantaneous energy requirements by four times throughout the darting speed range. This may account for the variations in performance time found in the tests on swimming speeds. Because of turbulence and pulsing, a maximum darting time of 7-1/2 seconds is a suggested value. As fish are capable of swimming for hours at the upper ranges of their cruising speeds, it is assumed that no oxygen deficiency occurs at this level. Above this level, fish apparently are not capable of passing water over their gills at the rate necessary to obtain this increased oxygen required for the additional energy expenditure.

In addition to the effects of oxygen and temperature, swimming performance is also adversely affected by various pollutants. Selected references are included to indicate the source material for those pollutants that are of major concern.

SWIMMING SPEEDS OF ADULT AND JUVENILE FISH

A Relative Swimming Speeds of Adult Fish

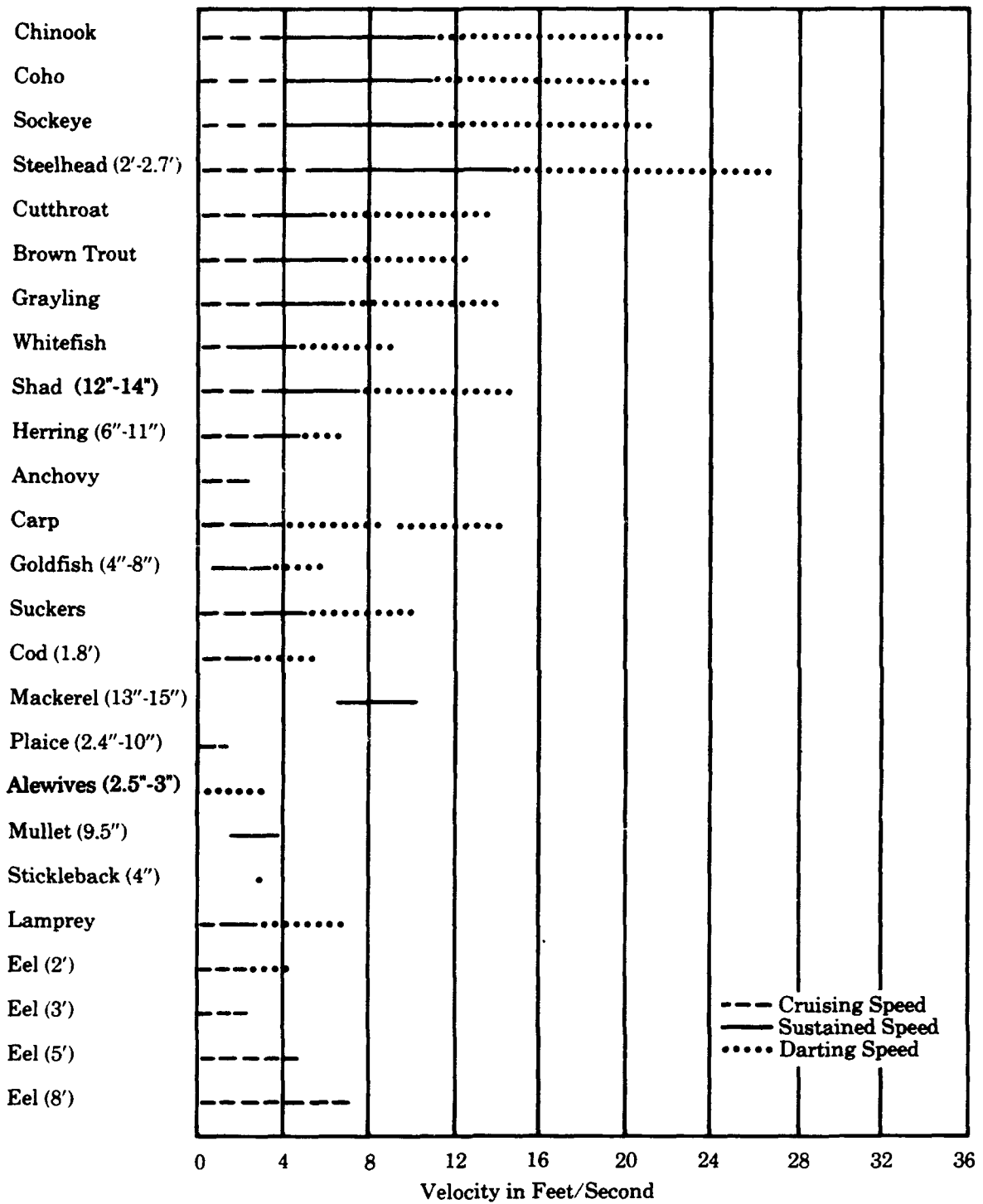

SWIMMING SPEEDS OF ADULT AND JUVENILE FISH

**B
Relative Swimming Speeds of Young Fish**

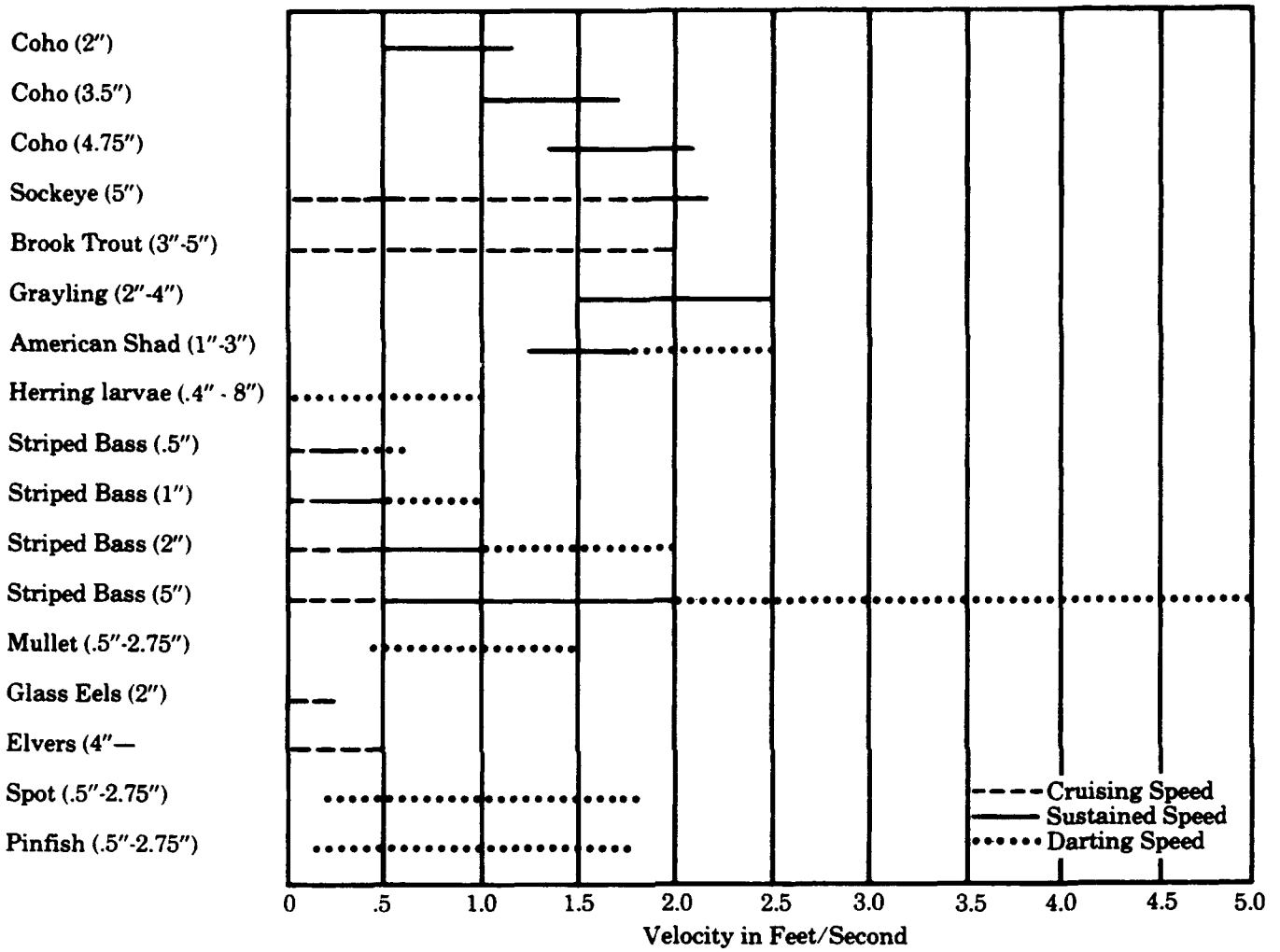

SWIMMING SPEEDS OF ADULT AND JUVENILE FISH

C Relative Swimming Speeds

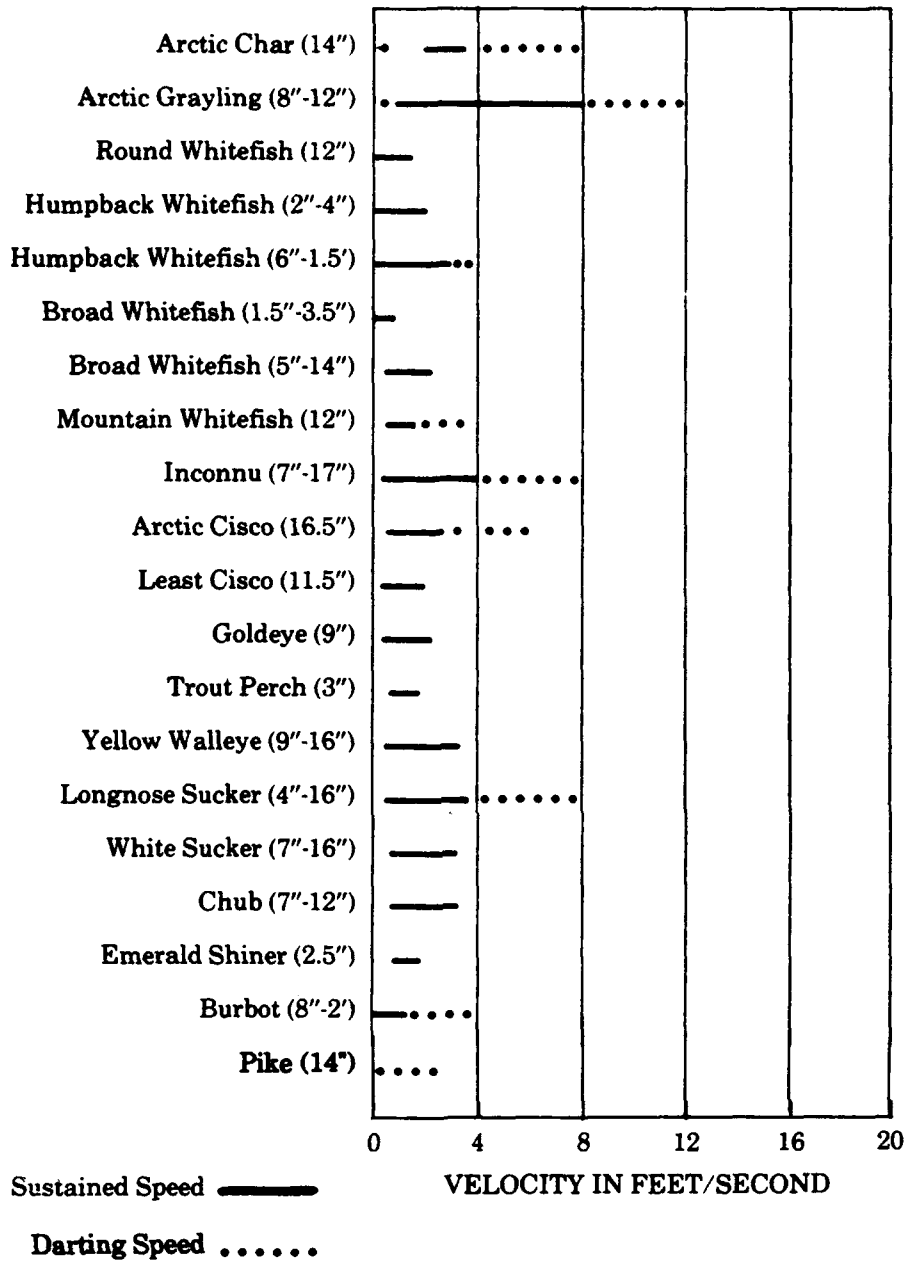

MacKenzie River data used for sustained speed.

Alaska data used to extend swimming speed to darting level.

SWIMMING SPEEDS OF ADULT AND JUVENILE FISH

D
Swimming Speed of
Sockeye Fry at Chilko Lake

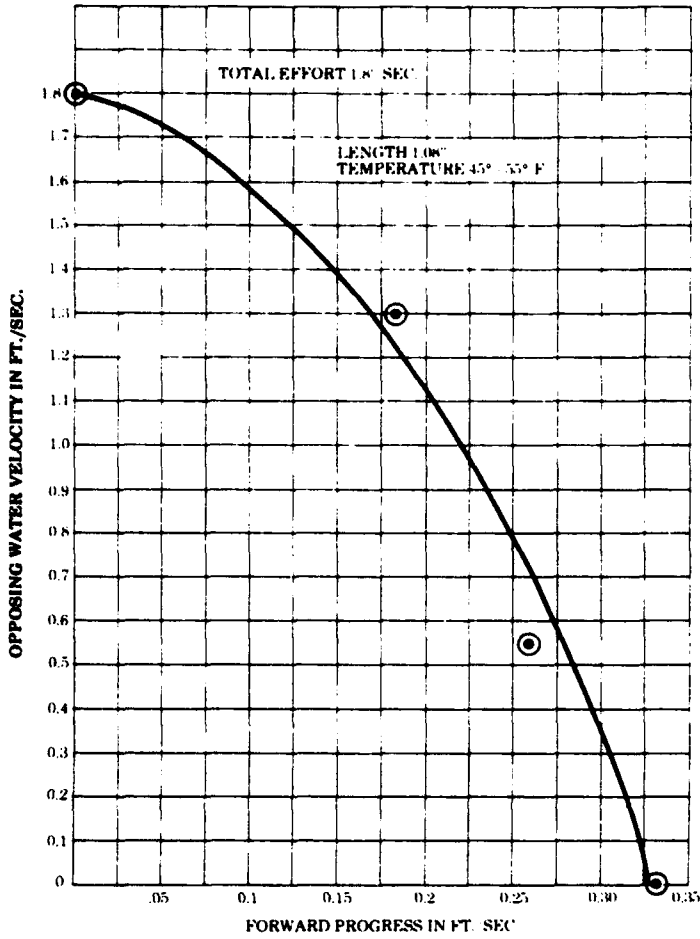

E
Maximum Sustained Cruising of
Sockeye and Coho Underyearlings
in Relation to Temperature

from Brett, 1958

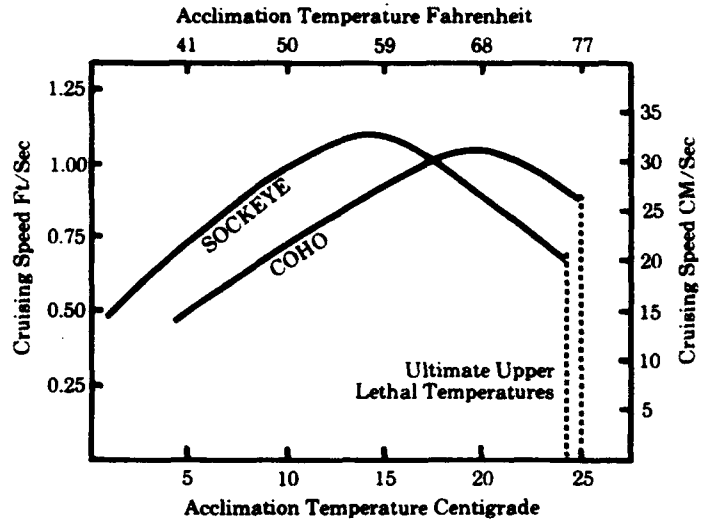

For 1 F. change approximately .026 fps is lost from the maximum point.

The point of maximum efficiency shifts throughout the fish's temperature range, based on adjustment to latitude of residence.

SWIMMING SPEEDS OF ADULT AND JUVENILE FISH

References Reviewed

1. Black, Edgar C., "Energy stores and metabolism in relation to muscular activity in fishes." In H.R. Macmillan Lectures in Fisheries, "The Investigation of Fish-Power Problems," pp. 51-67. Symposium held at the University of British Columbia, April 29-30, 1957, edited by P.A. Larkin. University of British Columbia, Institute of Fisheries, Vancouver. 1958.
2. U.S. Army Corps of Engineers, North Pacific Division, "Progress report on fisheries-engineering research program." Portland, Oregon. November, 1956.
3. U.S. Army Corps of Engineers, North Pacific Division, "Progress report on fisheries-engineering research program." Portland, Oregon. July, 1960.
4. Weaver, Charles R., "Observations on the swimming ability of adult American shad (*Alosa sapidissima*)." Transactions of the American Fisheries Society, 94(4):382-385. October, 1965.
5. Williams, I.V., "Implication of water quality and salinity in the survival of Fraser River sockeye smolts." International Pacific Salmon Fisheries Commission, Progress Report No. 22. New Westminster, B.C. 1969.
6. Calkins, Thomas P., "The effect of fin removal on the swimming ability of young silver salmon." Fisheries Research Institute, circular 109, College of Fisheries, University of Washington, Seattle. November 1959.
7. Canada Department of Fisheries and International Pacific Salmon Fisheries Commission, "A report of the fish facilities and fisheries problems related to the Fraser and Thompson River dam site investigations." Prepared in collaboration with the British Columbia Game Commission. Vancouver, B.C. November, 1955.
8. Idler, D.R., and W.A. Clemens, "The energy expenditures of Fraser River sockeye salmon during the spawning migration to Chilko and Stuart Lakes." International Pacific Salmon Fisheries Commission, Progress Report No. 6 New Westminster, B.C. 1959.
9. Dunstan, William, "Variations in the depot fats of Columbia River sockeye." In "Progress Report - Puget Sound Stream Studies," by W.E. Bostick, W.A. Dunstan, and W.H. Rees. Unpublished. Washington Department of Fisheries, Olympia. 1956.
10. Miller, Richard B., and Frances Miller, "Diet, glycogen reserves and resistance to fatigue in hatchery rainbow trout." Part II. Fisheries Research Board of Canada, Journal, 19(3):365-375. May, 1962.
11. Fields, Paul E., Ronald J. Adkins, and Gary L. Finger, "The swimming ability of immature silver salmon (*Oncorhynchus kisutch*) measured in an experimental flume." University of Washington, School of Fisheries, Technical Report No. 9. Seattle. 1954.
12. Wales, J.H., "Swimming speed of the western sucker (*Catostomus occidentalis* Ayres)." California Fish and Game, 36(4):433-434. October, 1950.
13. Parson, Green "How far and fast can salmon travel?" Salmon and Trout Magazine, No. 135:146-153. May, 1952.
14. Bainbridge, Richerd, "The speed of swimming fish as related to size and to the frequency and amplitude of the tail beat." Journal of Experimental Biology, 35(1):109-133. March, 1958.
15. Paulik, Gerald J., and Allan C. DeLacy, "Changes in the swimming ability of Columbia River sockeye salmon during upstram migration." College of Fisheries, Technical Report 46, University of Washington, Seattle. 1958.
16. Brett, J.R., M. Hollands, and D.F. Alderdice, "The effect of temperature on the cruising speed of young sockeye and coho salmon." Fisheries Research Board of Canada, Journal 15(4):587-605. July. 1958.
17. Connor, Anne R., Carl H. Elling, Edgar C. Black, Gerald B. Collins, Joseph R. Gauley, and Edward Trevor-Smith, "Changes in glycogen and lactate levels in migrating salmonid fishes ascending experimental 'endless' fishways." Fisheries Research Board of Canada, Journal 21(2):255-290. March, 1964.
18. Paulik, G.J., A.C. DeLacy, and E.F. Stacy, "The effect of rest on the swimming performance of fatigued adult silver salmon." School of Fisheries, Technical Report 31, University of Washington, Seattle. 1957.
19. Clancy, Dan W., "The effect of tagging with Petersen disc tags on the swimming ability of fingerling steelhead trout (*Salmo gairdneri*)." Fisheries Research Board of Canada, Journal, 20(4):899-908. July, 1963.
20. Brett, J.R., "The relation of size to the rate of oxygen consumption and sustained swimming speed of sockeye salmon (*Oncorhynchus nerka*)." Fisheries Research Board of Canada, Journal, 22(6):1491-1501. November, 1965.
21. Paulik, G.J., and A.C. DeLacy, "Swimming abilities of upstream migrant silver salmon, sockeye salmon and steelhead at several water velocities." School of Fisheries, Technical Report 44, University of Washington, Seattle. 1957.
22. Thomas, Allan E., and Roger E. Burrow, "A device for stamina measurement of fingerling salmonids." U.S. Fish and Wildlife Service, Research Report, No. 67. 1964.
23. Pretious, E.S., L.R. Kersey, and G.P. Contractor, "Fish protection and power development on the Fraser River." The Fraser River Hydro and Fisheries Research Project, University of British Columbia, Vancouver. February, 1957.
24. Collins, Gerald B., "Proposed research on fishway problems." Proposal submitted to the U.S. Army Corps of Engineers by the U.S. Fish and Wildlife Service.

SWIMMING SPEEDS OF ADULT AND JUVENILE FISH

References Reviewed (Continued)

25. Davis, Gerald E., Jack Foster, Charles E. Warren, and Peter Doudoroff, "The influence of oxygen concentration on the swimming performance of juvenile Pacific salmon at various temperatures." *Transactions of the American Fisheries Societies*, 92(2):111-124. April, 1963.
26. Felton, Samuel P., "Measurement of creative and inorganic phosphate in exercised and unexercised three-year-old hatchery steelhead trout." Unpublished report. School of Fisheries, Technical Report No. 29, University of Washington, Seattle. December, 1956.
27. Haley, Richard, "Maximum swimming speeds of fishes." In "Inland Fisheries Management," edited by Alex Calhoun, pp. 150-152. California Department of Fish and Game, Sacramento. 1966.
28. MacKinnon, Dixon, and William S. Hoar, "Responses of coho and chum salmon fry to current." *Fisheries Research Board of Canada, Journal*, 10(8):523-538. November, 1953.
29. Kerr, James E., "Studies on fish preservation at the Contra Costa steam plant of the Pacific Gas and Electric Company." California Department of Fish and Game, Fish Bulletin, No. 92. 1953.
30. Gray, James, "How fishes swim." *Scientific American*, 197(2):48-65. August, 1957.
31. Nakatani, Roy E., "Changes in the inorganic phosphate and lactate levels in blood plasma and muscle tissue of adult steelhead trout after strenuous swimming." Unpublished report. School of Fisheries, Technical Report 30, University of Washington, Seattle. May, 1957.
32. Orsi, James J., "Dissolved oxygen requirements of fish and invertebrates." In California Department of Fish and Game and the Department of Water Resources, "Delta Fish and Wildlife Protection Study," Report No. 6, pp. 48-68, Chapter IV. June, 1967.
33. Nakatani, Roy E., "Changes in the inorganic phosphate levels in muscle tissue of yearling steelhead trout after exercise." Unpublished report. School of Fisheries, Technical Report 28, University of Washington, Seattle. October, 1956.
34. Black, Edgar C., Anne Robertson Connor, Kwok-Cheung Lam, and Wing-gay Chiu, "Changes in glycogen, pyruvate and lactate in rainbow trout (*Salmo gairdneri*) during and following muscular activity." *Fisheries Research Board of Canada, Journal*, 19(3):409-436. May, 1962.
35. *The Progressive Fish-Culturist*, 27(3):157. July, 1965. (News note on swimming speeds.)
36. Nemenyi, Paul, "An annotated bibliography of fishways: covering also related aspects of fish migration, fish protection and water utilization." University of Iowa, *Studies in Engineering, Bulletin* 23. 1941.
37. Blaxter, J.H.S., "Swimming speeds of fish." *FAO Fish. Rep.* 62, Vol. 2, pp. 69-100. 1969.
38. Brett, J.R., "Swimming performance of sockeye salmon in relation to fatigue time and temperature." *Fisheries Research Board of Canada, Journal*, 24(8):1731-1741. 1967.
39. Jones, David R., Owen S. Bamford and Joe W. Kiceniuk, "An evaluation of the swimming performance of several fish species from the Mackenzie River." Department of Zoology, University of British Columbia, Vancouver, Canada, for the Department of the Environment, Fisheries and Marine Service, Central Region, Winnipeg, Manitoba. 69 pp. 1976.
40. Jones, D.R., J.W. Kiceniuk, and O.S. Bamford, "Evaluation of the swimming performance of several fish species from the Mackenzie River." *Fisheries Research Board of Canada, Journal*, 31:1641-1647. 1974.
41. Glova, G.J., and J.E. McInerny, "Critical swimming speeds of coho salmon (*Oncorhynchus kisutch*) fry to smolt stages in relation to salinity and temperature." *Fisheries Research Board of Canada, Journal*, 34:151-154. 1977.
42. Kotkas, Enn, "Studies of the swimming speeds of some anadromous fishes found below Conowingo Dam, Susquehanna River, Maryland." *Ichthyological Associates, Holtwood, Pa. For Conowingo Reservoir-Muddy Run Fish Studies Progress Report* 6, 22 pp. 1970.
43. Fisher, Frank W., "Swimming ability of juvenile American shad (*Alosa sapidissima*)." California Department of Fish and Game, Anadromous Fisheries Branch, Administrative Report No. 76-9, 6p. August, 1976.
44. Ware, D.M., "Growth, metabolism, and optimal swimming speed of a pelagic fish." *Fisheries Research Board of Canada, Journal*, 32:33-41. 1975.
45. Howard, T.E., "Swimming performance of juvenile coho salmon (*Oncorhynchus kisutch*) exposed to bleached draft mill effluent." *Fisheries Research Board of Canada, Journal*, 32:789-793. 1975.
46. Webb, P.W., "Hydrodynamics and energetics of fish propulsion." *Fisheries Research Board of Canada, Journal*, 190:159, p. 1975.
47. Rulifson, Roger A., "Temperature and water velocity effects on the swimming performances of young of the year striped mullet (*Mugil cephalus*), spot (*Leiostomus xanthurus*), and pinfish (*Legodon rhomboides*)." *Fisheries Research Board of Canada, Journal*, 34:2316-2322. 1977.
48. Jones, F.R. Harden, "Fish migration." *Fisheries Laboratory, Lowestoft. St. Martin's Press, New York.* 1968.

SWIMMING SPEEDS OF ADULT AND JUVENILE FISH

References Reviewed (Continued)

49. Laevastu, Taivo, and Ilmo Hala, "Fisheries oceanography--New ocean environmental services." Fishing News (Books) Ltd., London, England. 1970.
50. MacPhee, Craig, and Fred J. Watts, "Swimming performance of Arctic grayling in highway culverts." University of Idaho. Progress Report for U.S. Fish and Wildlife Service. Contract No. 14-16-0001-5207. January, 1975.
51. Wagner, Charles, "Species common to the Hudson River." Personal communication.
52. Peterson, R.H., "Influence of fenitrothion on swimming velocities of brook trout (*Salvelinus fontinalis*)." Fisheries Research Board of Canada, Journal, 31:1757-1762. 1974.
53. Brett, J.R., and N.R. Glass, "Metabolic rates and critical swimming speeds of sockeye salmon (*Oncorhynchus nerka*) in relation to size and temperature." Fisheries Research Board of Canada, Journal, 30:379-387. 1973.
54. Brett, J.R., "Energy expenditure of sockeye salmon, *Oncorhynchus nerka*, during sustained performance." Fisheries Research Board of Canada, Journal, 30:1799-1809. 1973.
55. Smith, Lynwood S., and Lili T. Carpenter, "Salmonid fry swimming stamina data for diversion screen criteria." Fisheries Institute, University of Washington. Final report for Washington State Department of Fisheries and Washington State Department of Game, December, 1987.
56. Oseid, Donavon, and Lloyd L. Smith, Jr., "Swimming endurance and resistance to copper and malathion of bluegills treated by long-term expose to sublethal levels of hydrogen sulfide." Transactions of the American Fisheries Society, 4:620-625. 1972.
57. MacLeod, John Cameron, and Lloyd L. Smith, Jr., "Effect of pulpwood fiber on oxygen consumption and swimming endurance of the fathead minnow, *Pimephales promelas*." Transactions of the American Fisheries Society, 95:711-84. 1966.
58. Webb, P.W., and J.R. Brett, "Effects of sublethal concentrations of sodium pentachlorophenate on growth rate, food conversion efficiency, and swimming performance in underyearling sockeye salmon (*Oncorhynchus nerka*)." Fisheries Research Board of Canada, Journal, 30:499-507. 1973.
59. Waiwood, K.G., and F.W.H. Beamish, "Effects of copper, pH and hardness on the critical swimming performance of rainbow trout (*Salmo gairdneri* Richardson)." Water Research 12:611-619. Pergamon Press, Ltd. 1978.
60. Kent, Joseph C., Allan DeLacy, Takao Hirota and Billy Batts, "Flow visualization and drag about a swimming fish." Fisheries Research Institute, University of Washington. U.S. Naval Ordnance Test Station, China Lake, California. Contract No. N123(60530)20579A. 1961.
61. Alexander, R. McNeill, "Animal mechanics." University of Washington Press, Seattle. 1968. 346 pp.
62. Russell, George R., "Hydraulics." Henry Holt and Company, Inc., New York. Fifth ed. 1952. 468 pp.

Chapter 7

Spawning Criteria

Three types of spawning habits described: nest building, demersal eggs and adhesive eggs.

Oxygen requirements of eggs for development.

Effects of changes in water levels and velocities.

Size and shape of redds (including a sketch).

Temperature.

Energy utilization (Table 2).

Methods to obtain flow and width of a stream.

Effect of stream slope.

Effect of release of stored water.

Stranding of young fish by flows rapidly changed downward.

A. Method of Application of Optimum Criteria to a Particular Study Section.

B. Spawning Characteristic Curves, Typical Stream.

C. Redd Size Increases as Spawning Action Proceeds.

D. Hydraulic Geometry Exponents.

Four graphs (1, 2, 3 & 4) showing stream geometry.

References Reviewed.

SPAWNING CRITERIA

The general requirement is an environment in which the adults are able to spawn with a minimum of molestation.

The spawning habits of the most common species may be separated into three types:

1. Nest builders, including salmon, trout, char, catfish and most species of bass.
2. The group that produces demersal or free-floating eggs and larvae which develop rapidly in the current. (Well-known examples of this type are the striped bass and the American shad.)
3. The species that reproduce by means of adhesive eggs that attach themselves to aquatic plants or submerged rocks after extrusion. (Common examples of this type are the Sacramento perch, Columbia River smelt or *eulachon*, the surf smelts and other members of the family *Osmeridae*, and many of the minnow (*Cyprinidae*) and perch (*Percidae*) families.

The latter two types of reproduction (free-floating demersal eggs and adhesive eggs) are both subject to high losses from predation and environmental variations. Consequently, large numbers of eggs and larvae must be produced in order that a few may develop to maturity.

Salmon and trout are gravel nest builders and, while shad eggs are demersal and smelt eggs are adhesive, all of these species require clean gravel or sand for successful spawning. Much of the general information is briefed in Chapter 5, "Useful Factors in the Life History of the Most Common Species."

All deposited eggs require oxygen for development. Eggs deposited in stream beds are supplied with oxygen from percolated water, eggs deposited in lake areas are supplied with oxygen by surface currents or by the adult fish fanning, and eggs deposited in the volume of a stream are supplied with oxygen by the moving water. It follows, therefore, that these conditions for supplying oxygen must be maintained during the hatching period.

Variations in water levels and velocities may occur by naturally changing flows or lake levels. In streams in which the flow is regulated, the effects of such regulation require additional measurement. Stability in lake levels managed for water use, or half lakes resulting from the construction of dams for power development, storage, or flood control may create adverse conditions during critical spawning and hatching periods.

The operating curves of regulated lakes or half lakes should be used to determine the stability of the lake level during critical periods. Such operating curves are available, as they are developed as part of a project. From such curves, the magnitude of any change in lake level and discharges can be obtained. All such lakes or half lakes are subject to natural variations caused by the rate of inflow versus the rate of use. All such data should be obtained and evaluated for the potential of maintaining, or possibly increasing, production of lake-dwelling fish.

The eggs from fish that use side embayments in rivers for spawning are subject to natural water level changes and, in stream areas below regulating reservoirs, are subject to potentially hourly or daily changes. The effect of either type of change can be determined from field studies, and may be required for project licensing. Fish that use a stream bed to spawn are subject to natural variations or to changes resulting from water releases (up and down).

Stream examinations are usually conducted to evaluate level variations for both depth and velocity.

In general, salmon and trout spawn in the same type of stream areas with depth factors somewhat commensurate with the weight of the fish. Trout select areas ranging from 6 inches to 2.5 feet in depth; salmon spawn between ranges of 9 inches and 4 feet.

See Chapter 27, "Artificial Spawning Grounds."

The redds vary in size as shown in the following table:

Table 1

Species	Reference	Approx. Average Wt.-lbs.	Average Area of Redd-sq. yds.	Area recommended per spawning pair - sq. yds. (includes defense area)
Chinook a. summer & fall run	Burner	25	6.1	24
b. spring run	"	15	3.9	16
Coho	"	9	3.4	14
Chums	"	10	2.7	11
Sockeye	"	3	2.1	8
Chinook (spring run)	Chambers et al		13	
Pinks	Hourston & MacKinnon	5	0.7	0.7
Trout	Stuart	1(?)	0.3	2

C.H. Clay, Design of fishways and other fish facilities. Canada Department of Fisheries, Ottawa. 1961.

SPAWNING CRITERIA

Generally, the velocity at the bed of the stream (over the spawning bed) is less than the sustained speed of the adult fish. See Chapter 6, "Swimming Speeds of Adult and Juvenile Fish," which gives velocities ranging between 1.5 and 3 fps.

During the spawning act a defense area against encroachment is enforced by the spawning pair. The size of this area is shown on Table 1. In the best spawning areas, superimposition of redds by later spawners may occur. The eggs are laid in clusters at depths of 6 to 10 inches and covered by gravel. A square foot of good spawning bed contains from 125 to 200 eggs. False redds may be dug and abandoned; pink salmon particularly are noted for this phenomenon.

The number of fish that may use a spawning area because of an unusually large run or diminished spawning areas may result in spawn being deposited in undesirable locations, such as in the periphery of a stream area which may become dried at lower stages. If fish are denied access to proper spawning grounds, females may die unspawned or the eggs may be deformed.

As temperature is a major factor in success of spawning, the limitations shown in Chapter 11, "Temperature-Effects on Fish," are necessary for reproduction. During their tender stage, eggs are particularly sensitive to adverse temperature changes or movement.

The physical measurements of spawning grounds have been taken from a number of sources and represent hundreds of measurements of desirable spawning reaches of river. Velocities, depths and flows must match the timing or runs and temperature requirements. Absence of one of these factors is sufficient to negate the effectiveness of others.

Exhibits A and B depict one method of evaluating the area of the stream bed utilized by fish for spawning. As velocity and depth are both limiting factors, they both must be within the optimum range. Similar techniques have been developed by other agencies and are equally useful. (See also 12.4.)

Anadromous salmonids, which do not feed from their time of entry into fresh water, live on their stored energy. Table 2 shows the general energy utilization, although this varies among species and distances from the stream mouth.

Table 2
Percent Energy Utilization

	Males	Females
Life Maintenance	60-70	50-60
Swimming	10-12	10-12
Nest building activities	1-2	3-5
Gonad and egg development	5-6	16-18
Residual (at death)	8-10	12-15

As noted in the above table, life maintenance requirements account for the greatest expenditure of energy. As fish are cold-blooded animals, the energy utilization is a function of temperature. This relationship is shown in Chapter 11, "Temperature - Effects on Fish." If the

temperature is elevated during migration or spawning, the body requirements for life maintenance may exhaust the available supply of energy and result in early death prior to spawning. It has been noted that a sudden drop in temperature will cause all spawning activity to cease, which can result in lowered nest building activity and reduced production.

A means of computing energy requirements for swimming is shown in Chapter 6, "Swimming Speeds of Adult and Juvenile Fish."

The energy requirements for gonad and egg development can be computed from the weight of the sex products.

The energy requirement shown for nest building is an approximation, computed from the swimming activities.

To assist in a preliminary evaluation of changes in a natural stream channel by flow variations, a preliminary estimate of the effects of such changes may be obtained by utilizing the relationships of flow to depth, flow to velocity and flow to wetted stream width. Flow in cubic feet of water per second (Q), raised to a power and multiplied by a multiplier, may be used to determine surface width, average velocity and average depth.

Width may be obtained by using a multiplier (a) times the flow, raised to a power (b). The average velocity may be obtained by using a multiplier (k) times the flow, raised to a power (m). The average depth may be obtained by using a multiplier (c) times the flow, raised to a power (f). The multipliers, when multiplied together, should equal one. The powers used when added together should equal one.

Stream slope is a major factor, within which slope are various reaches that may be greater or less than the overall stream slope, i.e. a pool and riffle type of stream. The pavement of the stream bed surface is related to the maximum column velocities during flood stages. As gravel bed size is related to pavement size, steep streams or steep riffle slopes may not be usable to spawning fish because of the large-sized pavement rocks needed to maintain a stable stream bed. As the rise approaches 100 feet to the mile, the availability of suitable bed conditions become restricted.

The influence of slope has a significant effect on two of the spawning criteria, velocity and depth. The overall slope of a stream may be used, but preferably a reach slope, that is the area involved, should be used. A pool and riffle river is an example of reach slopes versus the general river slopes.

In trout areas, there may be limited spawning in sheltered areas below large boulders. Food needed by the emerging fry is also limited in steep streams. (See Chapter 8, "Food Producing Areas.")

Stream bed stability or gravel sizes, as related to column velocities, are shown by table in Chapter 32, "Channel Changes."

Exhibit C indicates the advance of the spawning bed as the nest building continues. The eggs are laid in clusters and subsequently are covered with gravel. The shaping of the redd by digging results in percolation of water through the beds. The nest building tends to clean the gravel and the beds become spongy.

SPAWNING CRITERIA

To understand the geometry of a stream, the interrelationships of flow, width and depth for the widely varying flows throughout a water year must be known. If there are available USGS runoff data, these relationships can be obtained for any specific stream so measured. The average daily flow may be determined from the annual runoff in acre feet for a specific stream. For purposes of initial evaluation, if relationships can be established for a basin they may be used in evaluating tributary streams.

In evaluating tributary streams, a number of representative reaches should be examined. Most streams have increasing flow through their length as water enters the stream. There are exceptions: Streams from a productive water source passing through arid or semi-arid areas may lose water by evaporation and seepage. Occasionally, there are streams that lose water in their delta areas by excessive seepage. While diversions of water for any purpose will reduce the flow, return flows from irrigated areas may augment the flows, with a lag time between the water application and its return. It may be expected that river gradients flatten as they approach the mouths or deltas.

Utilizing the relationships for Washington streams, it is possible to determine changes in width, depth and velocity for critical flows. One hundred, fifty-four streams in western Washington and 61 streams in eastern Washington were examined to determine the relationship of average minimum flow to mean flow and mean flow to average maximum flow. The following values were obtained: from minimum to mean in western Washington, 9.78, and in eastern Washington, 9.95; from mean to average maximum in western Washington, 10.92, and in eastern Washington, 7.72.

Streams may have different sets of power factors to be used with flow. See Exhibit D, Hydraulic Geometry Exponents, which has been prepared to show a method that may be used to determine the changes in width, depth, and average, column and bottom velocity at reach slope. It gives the power factors that may be used for a general stream and for specific reaches, with shapes shown. It is suggested that for obtaining width, depth and velocity changes in a reach, exponents 0.3, 0.4 and 0.3 be used, as they cover the bed shapes shown, the last shape being a walled channel.

Under natural conditions of stream flow, major changes brought about by storms, or in some cases melting snow, may take hours or days to alter their flow relationship. Spawning fish may respond to such changes by retreating from the redds at peak flows to areas of low velocity and then returning to the original redd site as the flows drop, until spawning is completed.

The release of stored water may reach its peak change in a matter of a few hours; then cut off, retreat and reverse the increased changes. Such changes may occur more than once a day. These changed flows may interfere with spawning by causing the fish to retreat for shelter.

The methods that have been described for determining the effects of flow changes may be used to depict the severity of these changes, although field studies may be needed to evaluate the calculated changes.

Stranding of young fish or the drying of redds can also result if the flows are rapidly changed downward. The methods shown here can be used for evaluation of such potential effects. Again, field studies may be required specifically to determine the slopes of bars, on which pools may form and young be stranded.

Procedures can be followed by using the hydraulic geometry of the stream to show the effects of width, depth and velocity at various flow levels.

Dimensionless curves showing distribution of velocities over the depth of flow d in Graph 1 were calculated using the logarithmic velocity profile theory. V is the local depth-averaged velocity. According to this theory, the velocity u at distance y above the bottom is equal to V at $y/d = 0.37$. USGS stream gaging practice assumed $u = V$ at $y/d = 0.4$. At $y/d = 0.05$, the bottom velocity is approximately $0.6 V$. Also, V is approximately 0.8 times the maximum velocity.

The dimensionless profiles of depth-averaged velocities shown in Graph 2 are based on velocities calculated at various distances X from the water edge for the three representative channel cross-sections shown. \bar{V} is the overall average velocity, Q/A , for the cross-section. Near the bank, the local velocity can be approximated as about $1/6$ of the maximum velocity, which occurs at the channel centerline.

Graph 3 shows three slopes for velocity, depth and width related to changing flows.

Graph 4 shows the changes in width, depth and velocity related to changing slopes with the same roughness factor and bed shapes.

See Chapter 32, "Channel Changes," for formulae for developing average cross sectional velocities in a stream.

See also Chapter 27, "Artificial Spawning Channels."

SPAWNING CRITERIA

A

Method of Application of Optimum Criteria to a Particular Study Section

Washington State Department of Fisheries,

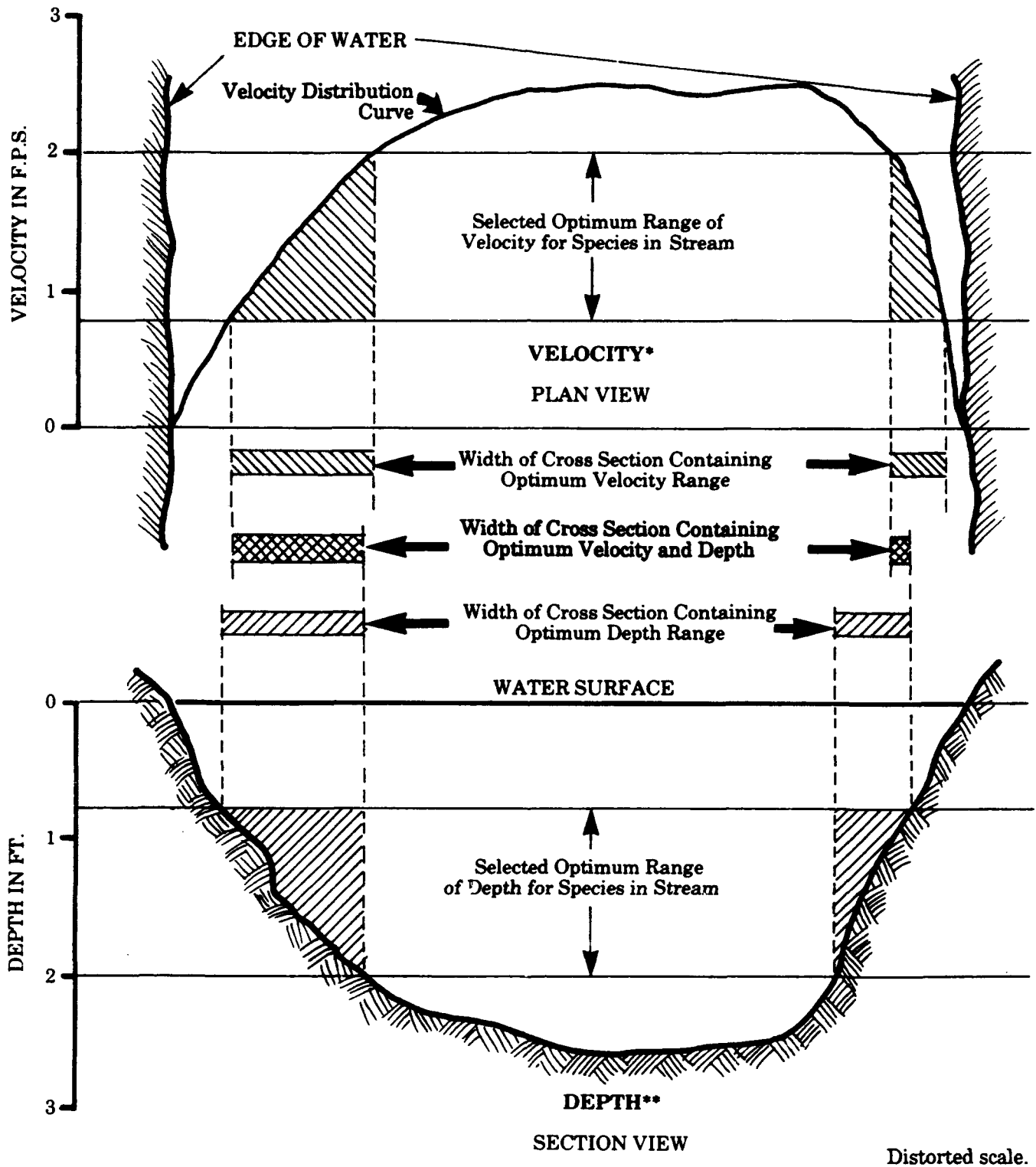

Distorted scale.

*Fish Velocity - Taken at Spawning Depth, ie. 0.4 ft Above Bottom.

**Depth Exaggerated for Clarity on this Diagram.

SPAWNING CRITERIA

B

Spawning Characteristic Curves, Typical Stream

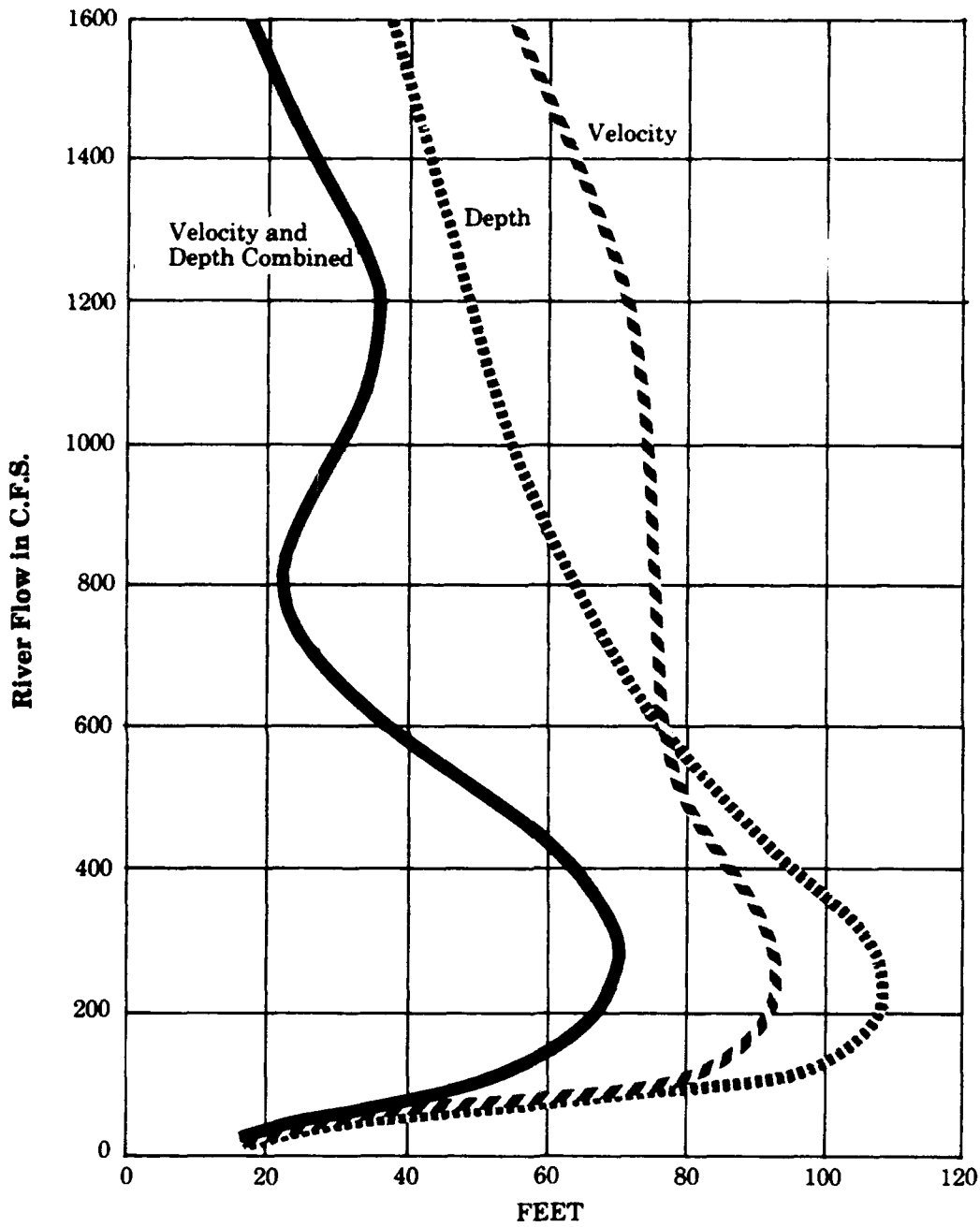

Width of Section Having Optimum Spawning Conditions

Washington State Department of Fisheries

SPAWNING CRITERIA

C

**Redd Size Increases
As Spawning Action Proceeds**

After Clifford J. Burner

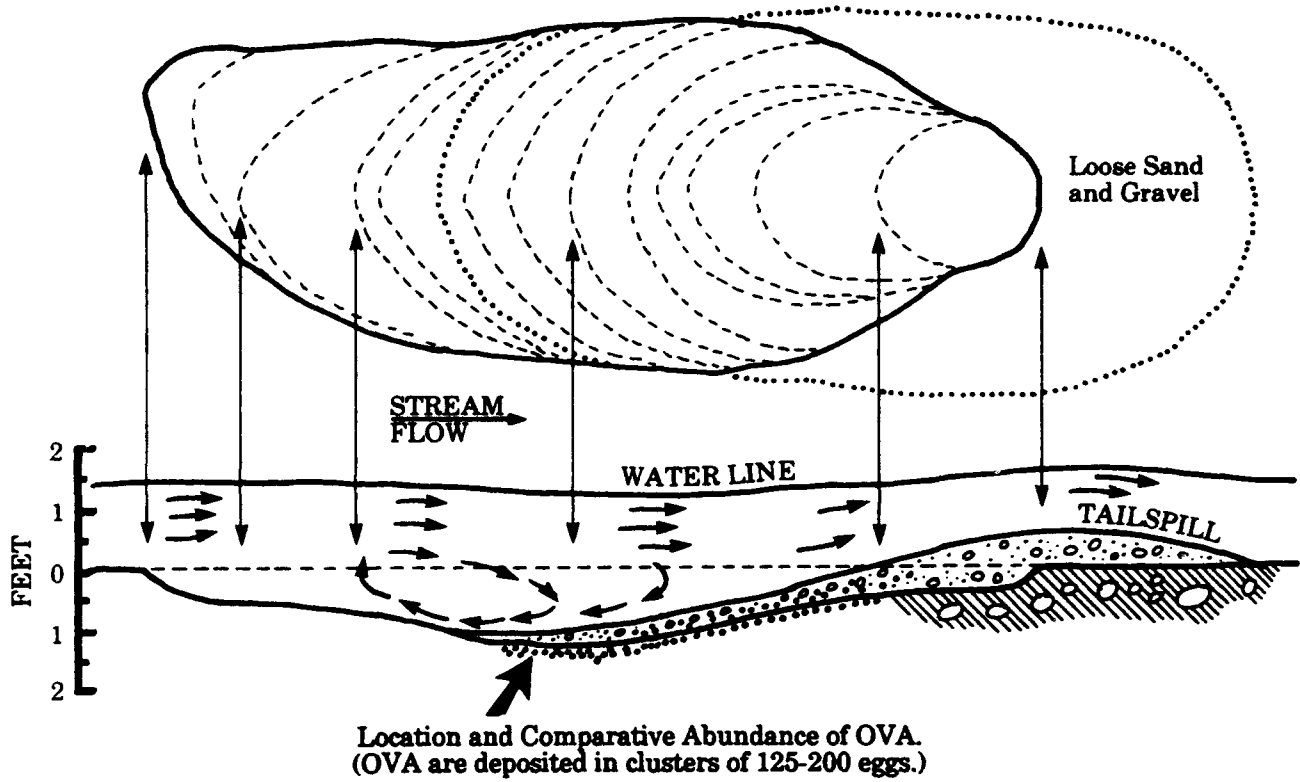

See Page 12.4.

SPAWNING CRITERIA

D

Hydraulic Geometry Exponents

$$Q = WdV$$

$$= aQ^b cQ^f kQ^m$$

Reference	Width b	Depth f	Velocity m
Leopold & Mattock at a station	.26	.40	.34
Leopold & Mattock Parker Downstream variation along a basin, based on mean annual Q	.5	.4	.1
Bell Handbook 1980 General stream	.6	.3	.1

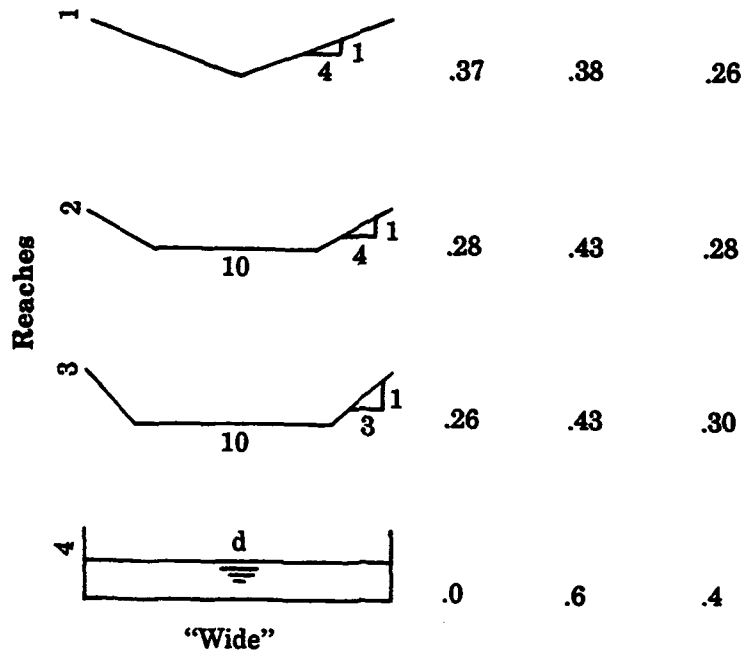

$$R = d \text{ (depth)}$$

$$R = \text{Hydraulic radius} \frac{\text{Area}}{\text{Wetted perimeter}}$$

by R.E. Nece

SPAWNING CRITERIA

Graph 1

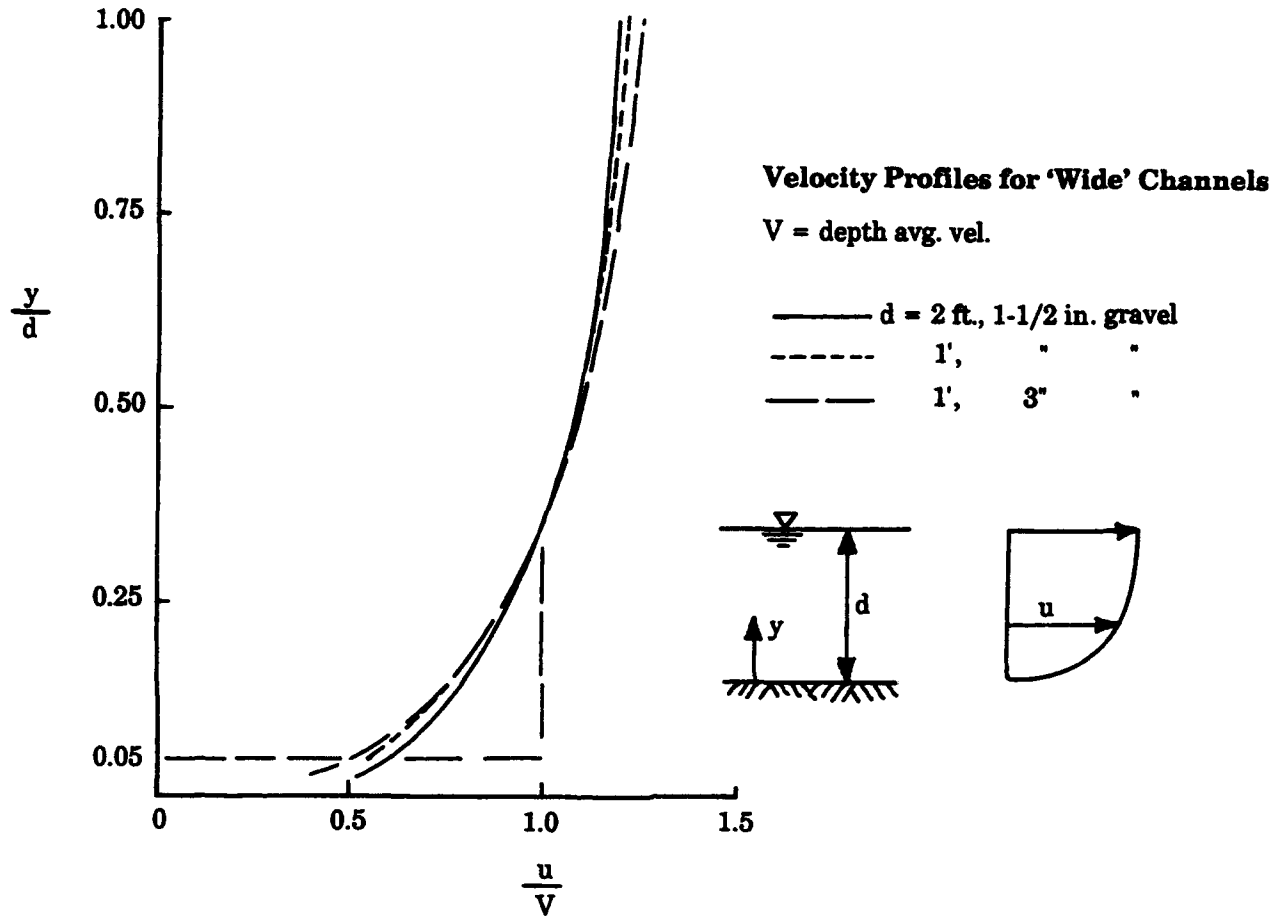

Logarithmic Velocity Profiles

Ref: H. Rouse, "Engineering Hydraulics"

By R.E.N.

SPAWNING CRITERIA

Graph 2

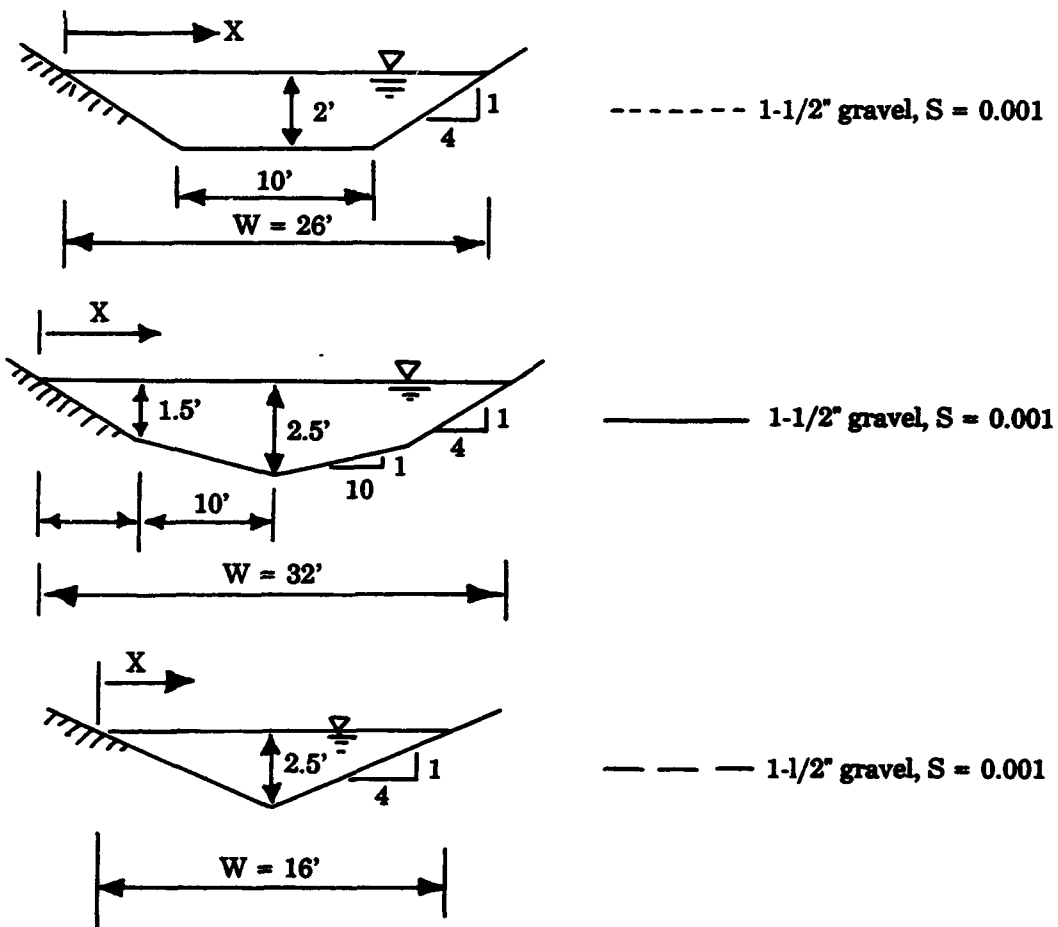
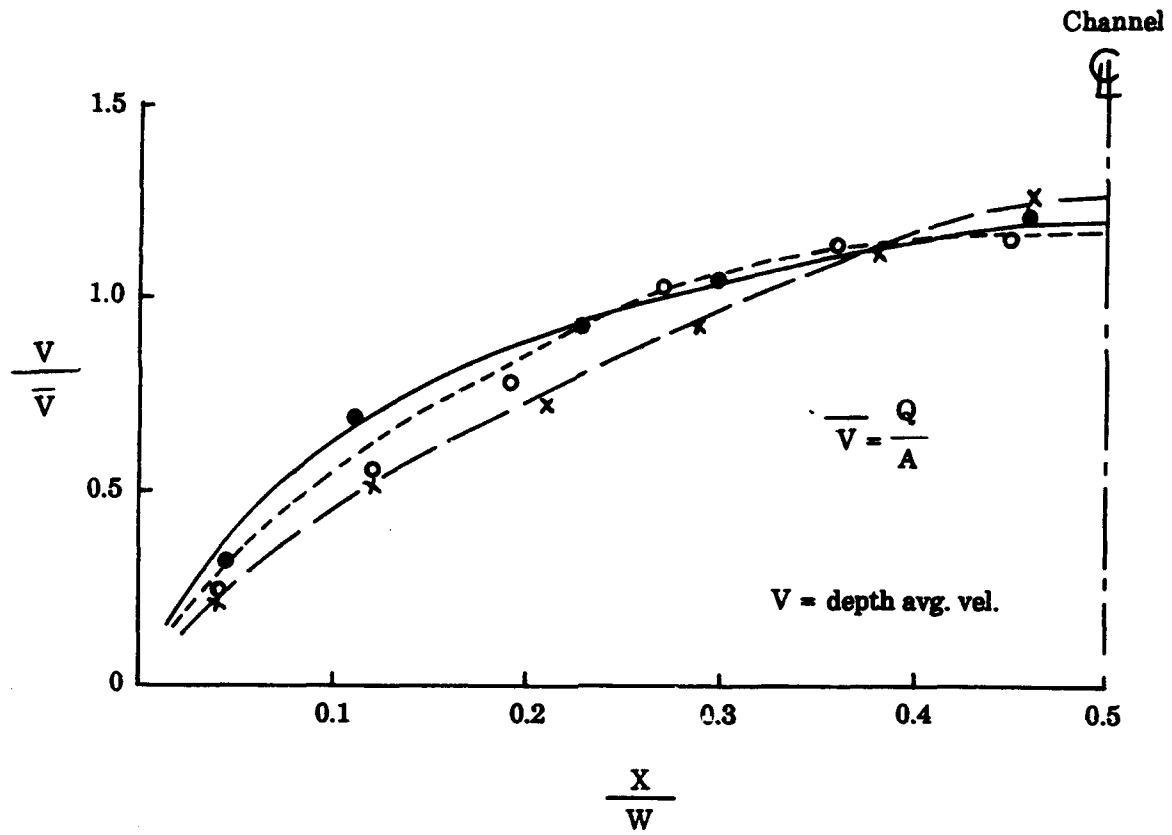

By R.E.N.

SPAWNING CRITERIA

Graph 3

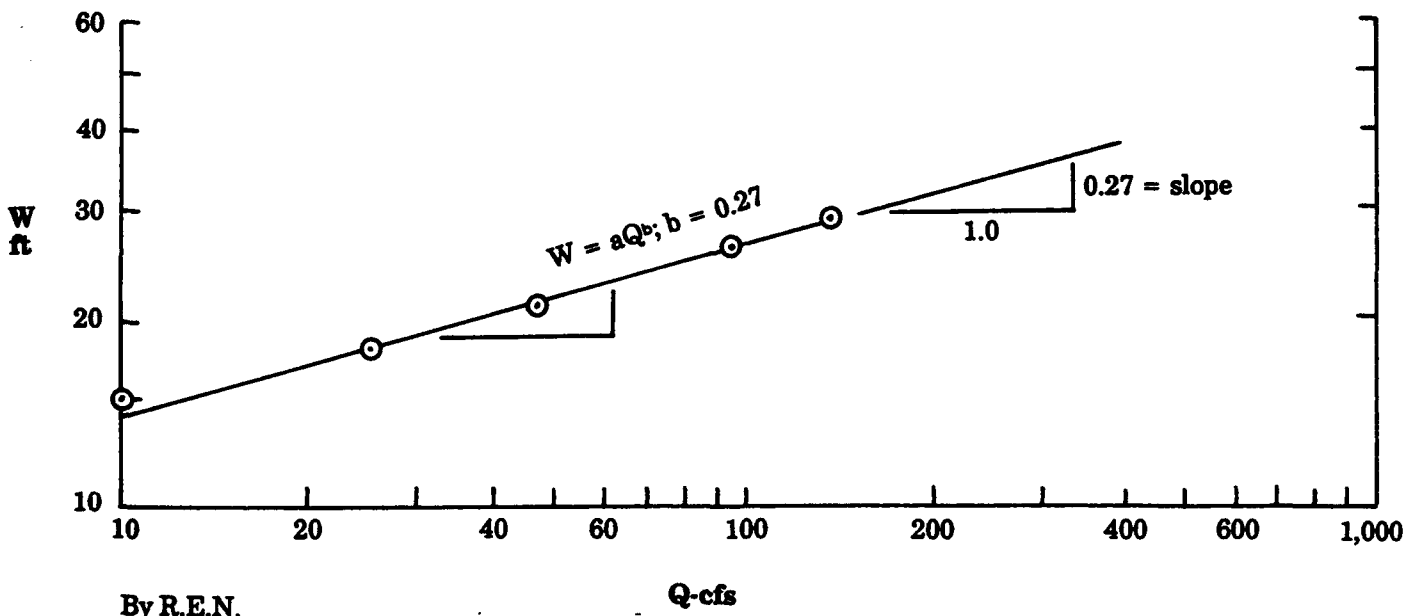
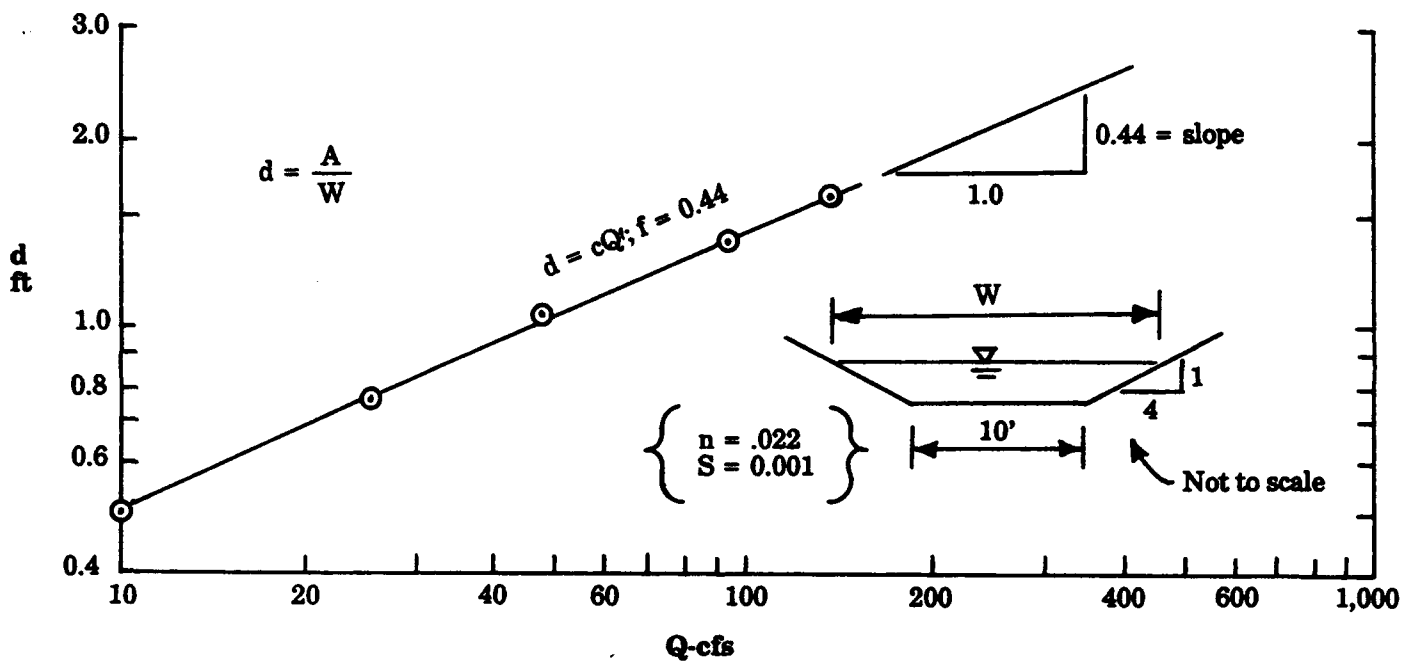
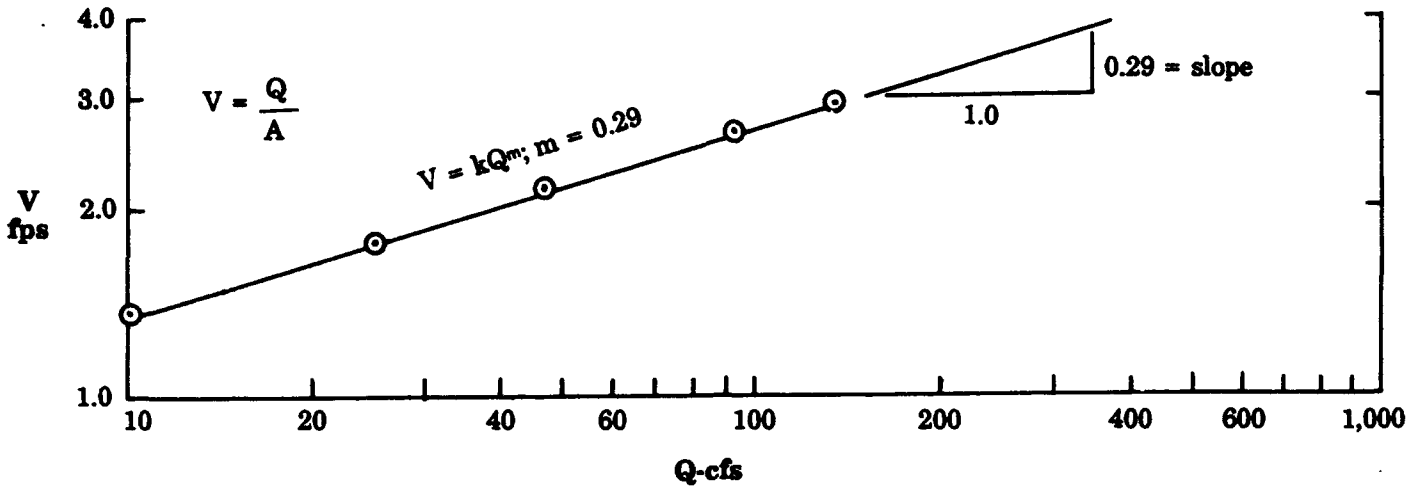

By R.E.N.

SPAWNING CRITERIA

Graph 4

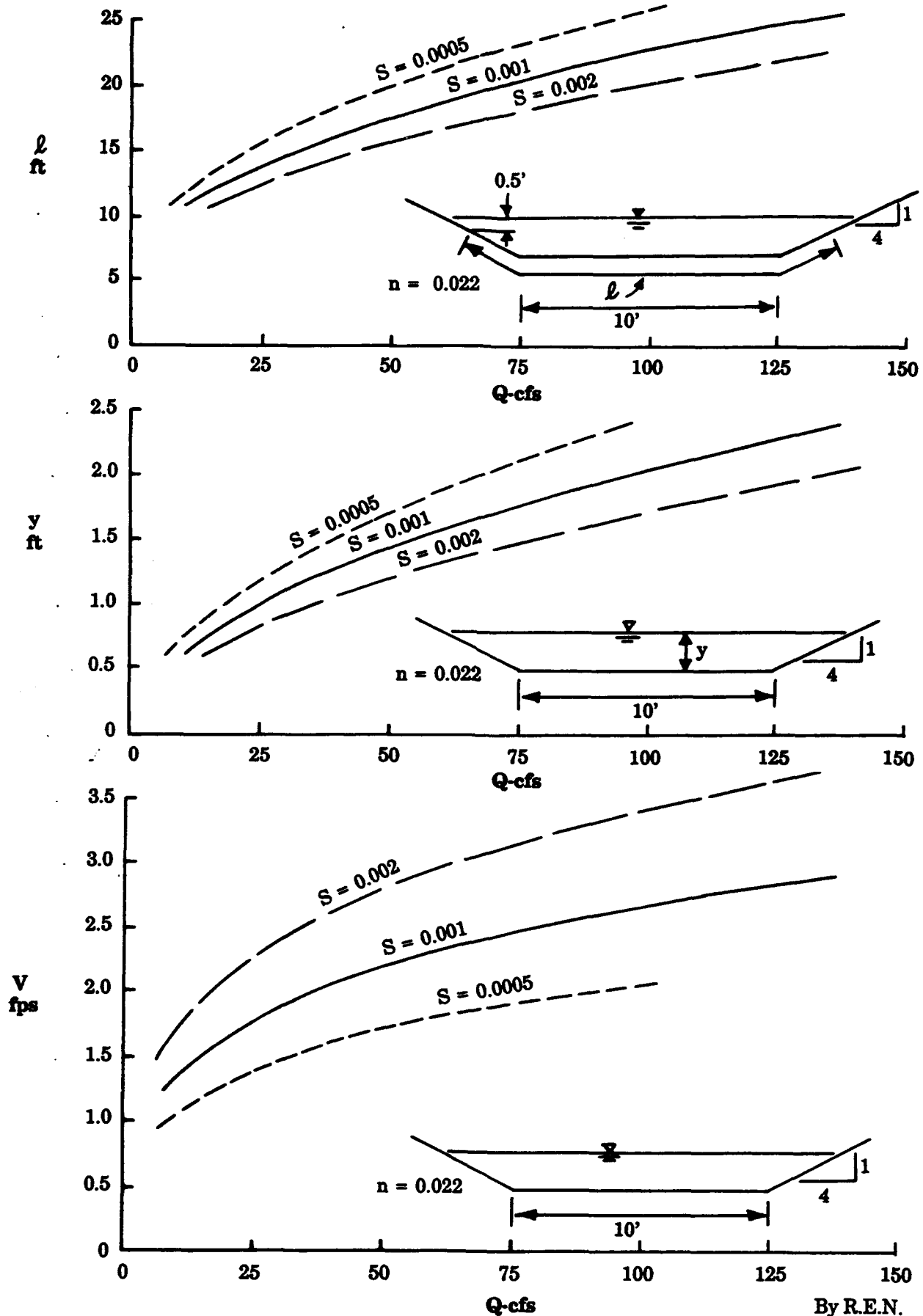

By R.E.N.

SPAWNING CRITERIA

References Reviewed

1. Chambers, John S., George H. Allen, and Richard T. Pressey, "Research relating to study of spawning grounds in natural areas." Washington Department of Fisheries, Unpublished Annual report to U.S. Army Corps of Engineers, Contract No. DA 35026-Eng-20572.
2. Stockley, Clinton, "New methods of artificially planting salmon eggs." *The Progressive Fish-Culturist*, 16(3): 137-138. July, 1954.
3. Hobbs, Derisley, "Natural reproduction of Quinnot salmon, brown and rainbow trout." New Zealand Marine Department, Fisheries Bulletin No. 6. Wellington. 1937.
4. Pressey, Richard T., John S. Chambers, and George H. Allen, "Research relating to study of spawning grounds in natural areas." Washington State Department of Fisheries, Unpublished Progress reports, Feb. 1, 1954 through July, 1955, to U.S. Army Corps of Engineers, Contract No. DA 35026-Eng-20572. Olympia. 1955.
5. Chambers, John S., R.T. Pressey, J.R. Donaldson, and W.R. McKinley, "Research relating to study of spawning grounds in natural areas." Washington State Department of Fisheries, Unpublished Annual Report to U.S. Army Corps of Engineers, Contract No. DA 35026-Eng-20572. Olympia. 1954.
6. McNeil, William J., and Warren H. Ahnell, "Success of pink salmon spawning and relative to size of spawning bed materials." U.S. Fish and Wildlife Service, Special Scientific Report - Fisheries No. 469. Washington, D.C. January, 1964.
7. Stout, Wendell H., "Stream surveys and fish relocation feasibility studies." Unpublished. Oregon State Game Commission, Portland. 1957.
8. Olson, P.A., and R.F. Foster, "Temperature tolerance of eggs and young of Columbia River chinook salmon." *Transactions of the American Fisheries Society*, 85: 203-207. 1955.
9. Allen, George H., and John S. Chambers, "Research relating to study of spawning grounds in natural areas: notes on silver and chum salmon in Burns and Spaight Creeks, Fall, 1954 and Winter, 1955." Washington State Department of Fisheries. Unpublished. Supplemental progress report of U.S. Army Corps of Engineers, Contract No. DA 35026-Eng-20572. July 15, 1955.
10. Mottley, C., "Loss of weight by rainbow trout at spawning time." *Transactions of the American Fisheries Society*, 67:207-210. 1937.
11. Briggs, John C., "The behavior and reproduction of salmonoid fishes in a small coastal stream." California Department of Fish and Game, Fish Bulletin 94:31-37. 1953.
12. Pressey, Richard T., John S. Chambers, and George H. Allen, "Research relating to study of spawning grounds in natural areas." Washington State Department of Fisheries, Unpublished Progress report, February 1, to March 1, 1955, to U.S. Army Corps of Engineers, Contract No. DA 35026-Eng-20572. Olympia. 1955.
13. Chapman, Wilbert McLeod, "The spawning of chinook salmon in the main Columbia River." *Copeia*, No. 3:168-170. October 15, 1943.
14. Pyefinch, K.A. and D.H. Mills, "Observations on the movements of Atlantic salmon (*Salmo salar* L.) in the River Conon and the River Meig, Ross-shire I." Scotland Department of Agriculture and Fisheries, Freshwater and Salmon Fisheries Research, No. 31. 1963.
15. Chambers, John S. "Propagation of fall chinook salmon in McNary Dam experimental spawning channel." Washington State Department of Fisheries, Unpublished Summary report (1957 through 1963) to U.S. Army Corps of Engineers, Contract No. DA 45-164-Civeng-65-4. Olympia. 1964.
16. McNeil, William J., "Effect of the spawning bed environment on reproduction of pink and chum salmon." U.S. Fish and Wildlife Service, Fishery Bulletin 65(2): 495-523. Washington, D.C. 1966.
17. Salo, Ernest O. and William H. Bayliff, "Artificial and natural production of silver salmon (*Oncorhynchus kisutch*) at Minter Creek, Washington." Washington State Department of Fisheries, Research Bulletin 4. January, 1958. (revision of the senior author's Ph.D thesis)
18. McNeil, William J., "Environmental factors affecting survival of young salmon in spawning beds and their possible relation to logging." U.S. Fish and Wildlife Service, Bureau of Commercial Fisheries. Manuscript report no. 64-1. Washington, D.C. April, 1964.
19. Sheridan, William L., "Relation of stream temperatures to timing of pink salmon escapements in Southeast Alaska." H.R. MacMillan Lectures in Fisheries - "Symposium on pink salmon," pp. 87-102. University of British Columbia, Vancouver. 1962.
20. Wickett, W.P., "Review of certain environmental factors affecting the production of pink and chum salmon." Fisheries Research Board of Canada, Journal, 15(5):1103-1126. September, 1958.
21. Shapovalov, Leo, "Experiments in hatching steelhead eggs in gravel." California Department of Fish and Game, 23(3):208-214. July, 1937.
22. Coble, Daniel W., "Influence of water exchange and dissolved oxygen in redds on survival of steelhead trout embryos." *Transactions of the American Fisheries Society*, 90(4):469-474. October, 1961.
23. McIrvin, Ronald David, "Fine particle movement through a granular bed." MS thesis. University of Washington, Seattle, Washington. 1965.

SPAWNING CRITERIA

References Reviewed (Continued)

24. Sheridan, William L., "Waterflow through a salmon spawning riffle in Southeastern Alaska." U.S. Fish and Wildlife Service, Special Scientific Report - Fisheries No. 407. Washington, D.C. 1962.
25. McKinley, W.R., "Relative abundance of optimum spawning area in the Lower Cowlitz River for anadromous fish as a function of river discharge." Unpublished report. Washington State Department of Fisheries, Olympia. February, 1956.
26. Terhune, L.D.B., "The Mark VI groundwater standpipe for measuring seepage through salmon spawning gravel." Fisheries Research Board of Canada, Journal, 15(5):1027-1063. September, 1958.
27. Massmann, William H., "Characteristics of spawning areas of shad, *Alosa Sapidissima* (Wilson), in some Virginia streams." Transactions of the American Fisheries Society, 81:78-93. 1952.
28. Vaux, Walter G., "Interchange of stream and intra-gravel water in a salmon spawning riffle." U.S. Fish and Wildlife Service, Special Scientific Report - Fisheries No. 405. Washington, D.C. March, 1962.
29. Hanavan, Mitchell G., and Bernard Einar Skud, "Intertidal spawning of pink salmon." U.S. Fish and Wildlife Service, Fishery bulletin 95. Washington, D.C. 1954.
30. Reimers, Paul E., "Cessation of chinook salmon spawning during a lunar eclipse." Oregon Fish Commission, Research briefs, 13(1):125. June, 1967.
31. Mead, R.W., and W.L. Woodall, "Comparison of sockeye salmon fry produced by hatcheries, artificial channels and natural spawning areas." International Pacific Salmon Fisheries Commission, Progress Report No. 20. New Westminster, B.C. 1968.
32. Burner, C.J., "Characteristics of spawning nests of Columbia River salmon." Fishery Bulletin, 52(61):97-110. Washington, D.C. 1951.
33. Krokhin, E.M., and F.V. Krogius, "Study of the basin of the Bolshaya River and its salmon spawning places." Translated by Dmitri Khrenov (March 1950) from Bulletin of the Pacific Scientific Institute of Fisheries and Oceanography (U.S.S.R.), 9:3-150. 1937.
34. Mattson, Chester R., "Spawning ground studies of Willamette River spring chinook salmon." Oregon Fish Commission, Research briefs, 1(2):21-32. August, 1948.
35. Canada Department of Fisheries, "Puntledge River: the fisheries problems associated with the power development of the Puntledge River, Vancouver Island, B.C." Vancouver, B.C. October, 1958.
36. Oregon State Game Commission, "The fish and wildlife resources of the Upper Willamette Basin, Oregon, and their water requirements." A report by James H. Hutchison, Kenneth E. Thompson, and John D. Fortune, Jr. Federal Aid to Fish Restoration, Progress report, Project F-69-R-5, Job number 1. Portland.
37. James, M.C., "Spawning reactions of small-mouthed bass." Transactions of the American Fisheries Society, 60:62-63. 1930.
38. Canada Department of Fisheries, "A report on the fisheries problems related to the power development of the Cheakamus River system." Vancouver, B.C. March, 1957.
39. Orcutt, Donald R., et al., "Characteristics of steelhead trout redds in Idaho streams." Transactions of the American Fisheries Society, 97(1):42-45. January, 1968.
40. Moffett, James W., and Standord H. Smith, "Biological investigations of the fishery resources of Trinity River, California." U.S. Fish and Wildlife Service, Special Scientific Report - Fisheries No. 12. Washaiangton, D.C. February, 1950.
41. Washington State Water Research Center, "A first estimate of future demands for water in the State of Washington." Report No. 2, volume 1 of its "An initial study of the water resources of the State of Washington." Washington State University, Pullman, Washington. February, 1967.
42. Fulton, Leonard A., "Spawning areas and abundance of Chinook salmon (*Oncorhynchus tshawytscha*) in the Columbia River basin - past and present." U.S. Fish and Wildlife Service, Special Scientific Report - Fisheries No. 571. Washington, D.C. October, 1968.
43. Meekin, Thomas K., "McNary supplemental spawning channel, summary report 1957 through 1966." Washington State Department of Fisheries Research Division, U.S. Army Corps of Engineers, NPD, Contract No. DA45-164-Civeng-65-4. September, 1967.
44. Fraser, J.C., "Regulated stream discharge for fish and other aquatic resources - an annotated bibliography." Food and Agriculture Organization of the United Nations, FAO Fisheries Technical Paper No. 112. September, 1972.
45. Alderdice, D.F., R.A. Bams, and F.P.J. Velson, "Factors affecting deposition, development, and survival of salmonid eggs and alevins." A bibliography, 1965-1975. Fisheries Marine Service Technical Report 743. 1977. 276 pp.
46. Bennett, George W. "Management of artificial lakes and ponds," Reinhold Publishing Corporation, New York. 1962. 283 pp.
47. Russell, George E., "Hydraulics." Fifth Edition. Henry Holt and Company, New York. 1952.

SPAWNING CRITERIA

References Reviewed (Continued)

48. King, Horace Williams, "Handbook of hydraulics." Fourth edition. McGraw-Hill Book Company, Inc. New York. 1954.
49. R. McNeill Alexander, "Animal mechanics." University of Washington Press, Seattle, Washington. 1968.
50. Leopold, Luna B., and Thomas Maddock, Jr., "The hydraulic geometry of stream channels and some physiographic implications." U.S. Geological Survey, Professional Paper No. 252. Washington, D.C. 1953. Reprinted, 1959.
51. Barnes, H.H., "Roughness Characteristics of Natural Channels." U.S.G.S. Water Supply Paper 1849. 1967.
52. Rouse, Hunter (Editor), "Engineering Hydraulics." Proceedings of the Fourth Hydraulics Conference, Iowa Institute of Hydraulic Research. June, 1949. John Wiley & Sons, Inc. New York, 1950.

Chapter 8

Food Producing Areas

General

Assessing food potential for fish production in streams and lakes.

Important physical parameters that affect food production.

Fish are specialized feeders.

Problems associated with using standing food crops as an indicator of an area's potential.

Light level for salmonoid feeding.

Lakes

Newly formed lakes highly productive.

Hydrogen sulfide found in lower layers of newly formed lakes.

Predator removal results in greater planting rate.

Loss of dissolved oxygen below thermocline a problem.

Fish production related in part to latitude, altitude and sun factor.

Comparison of yield as a percent of carrying capacity.

Effect on production rate of north-south temperature gradient.

Streams

Evaluation of food potential of an area.

Silt in normally clear streams lowers production.

Flood flows may reduce production.

Oxygen required for food production; affects feeding and growth rates of salmonids.

Factors affected by temperature.

Velocities for best food production between 1 and 3 fps; depths between .4 and 1 foot.

Effect of gradient on fish production.

Shapes of stream channels.

Energy control in streams.

Effective spawning and food production both limited to flows below annual average.

Sources for historical flow records and slope data.

A. Feeding Rate for Rainbow Trout of Various Sizes at Various Temperatures.

B. Energy Requirements (in K Per Day)* Compared with Oxygen Demands.

C. Food Conversions of Salmonids.

D. Effect of Feeding of Live Minnows to Brook Trout.

E. Daily Feeding Rate of Brook Trout (as Percent of Body Weight--All Meat Diet). Expected Daily Percentage Increase in Weight.

F. Percent Weight Gain of Fall Chinook Fingerlings during a 28-Day Period.

G. Percent Length Gain of Fall Chinook Fingerlings During a 28-Day Period.

H. Food Consumption at Various Temperatures and Sizes (Using Abernathy Soft Pellet 27.5 Percent Protein). Comparison of Abernathy Soft Pellet with Two Other Types of Food.

I. Digestion Time Required by Trout at Various Temperatures. Increase in Metabolic Rate Caused by Temperature Increase.

J. Percent Occurrence of Trout Food in Streams.

K. Gross Distribution of the Aquatic Invertebrate Fauna With Water Velocity, Mean Depth, and Substrate Particle Size.

L. Abundance and Volume of the Four Dominant Orders of Aquatic Insects by Months.

M. Average Standing Crop of Bottom Organism (No./Ft.²/Mo.).

N. Percentage Occurrence of Major Groups of Organisms in 289 Trout Stomachs.

O. Mean Monthly Averages and Trends for Quantity and Type of Material Ingested by Trout.

P. Condition of the Trout (K) in Relation to Utilization and Abundance of Bottom Organisms, Rate of Flow and Stream Temperature.

Q. Oxygen and Growth of Young Coho Salmon.

R. Rearing Characteristic Curve of Typical Stream.

S. Average Annual Escapement (Wild and Hatchery-Reared Fish) and Salmon Production in Selected Streams in the State of Washington.

References Reviewed.

FOOD PRODUCING AREAS

General

In assessing the food potential for the production of fish in fresh water, measurements are necessary in both streams and lakes.

In streams, the physical parameters that require measurement include width, wetted bed area and its roughness (gravel size), cross section, slope, quality, velocity gradient and flow in cubic feet per second. The relationships of pool, flat and riffle frequencies should be measured as variables in food production and energy balancing mechanisms.

In lakes, the measurements required include volume, depth, density gradient, surface area, inflow, discharge and clarity. Within these measured water areas there exists a complex relationship among growth, life maintenance requirements and the cropping of food organisms, all of which are limited by other major physical factors, such as temperature, altitude, dissolved solids and gases, turbidity, thermocline location and pollution.

Fish are specialized feeders to degrees that vary with species and size; however, because of the above parameters, the presence or absence of a specific food may not give a true index of the suitability of an area for fish production. The measurement of standing food crops is also not a true indicator of an area's potential, as the volume of a crop may be limited by the abundance of feeders in relation to the life cycle of the food organisms.

The feeding level of light for salmonids may begin at 0.01 foot candles, with the feeding rate ceasing below this level. Feeding is proportionate to the log of light intensity.

In soft water (below neutral), both plant and fish production are low, whereas in hard water (above neutral alkalinity) food production and fish production are generally high.

A principal concern has been with salmonoid fish whose production in any area reflects the stress of the environment. In order to set optimum water volumes, a more precise delineation than has been made is necessary to determine the relationship between the organisms on which these fish feed and the pounds of fish produced.

Lakes

When considering the pounds of fish present, fish size is important, as a lake supports fewer pounds of growing fish than adult fish.

The age of a lake is important, as it is commonly accepted that during the first three years of its life a newly-formed lake is highly productive, but this is not indicative of a firm level of production as the lake ages.

In some newly formed lakes, hydrogen sulfide has been found in the lower layers. If such water layers were to be diverted, particularly in half-lakes such as power reservoirs, the discharge from a powerhouse could be polluted, causing kills in the river below. The annual overturn may also bring such polluted water to the surface. This phenomenon disappears as the lake ages.

Lakes that are rehabilitated by the removal of predators may be planted at a rate at least four times greater than that of accepted planting practices. The range for trout planting is approximately 3 lbs per acre for fry, 6 lbs per acre

for 3- to 4-inch fish, 13 lbs per acre for 5- to 6-inch fish, 40 lbs per acre for 8- to 10-inch fish and 60 lbs per acre for 10- to 12-inch fish. Catchable production of 2-lb fish may vary between 25 and 60 lbs per acre.

Another problem that can occur in lakes is the loss of dissolved oxygen below the thermocline, causing oxygen deficiency. This can result from decaying vegetation. If oxygen-deficient water were to be discharged from a half lake, the stream immediately below the discharge outlet would be oxygen-deficient, with a resulting fish kill.

In geographical areas where ponds or small lakes become covered with ice, winter kills resulting from the low oxygen level can occur. This phenomenon can also occur in densely populated hatchery ponds that freeze over.

In a half-lake situation, when cold water is withdrawn from below the thermocline, the stream temperatures are lowered. In some cases, multiple level intakes are required to synthesize the normal river temperatures which existed before the operation of such recent lakes.

If turbid streams flow into large lakes, there can be stratified layers of water with high turbidity in the lakes which, if discharged, change the production of the stream below the lake.

If cold water fish are resident in a lake with high temperature surface layers, it must be recognized that such fish would require depths for survival and these depths, if oxygen-deficient, may be denied them. In such cases, cold water fish would disappear.

Fish production in lakes is related in part to latitude and altitude and to the sun factor. Available maximum growing time in the southern latitude (around 30 degrees) may be 12 months, or four times greater than in lakes at a latitude of 46 degrees, which is about 3 months. (Reference No. 57.)

Another comparison can be made of yield as a per cent of carrying capacity. At 30 degrees latitude the yield may be in excess of 100 per cent of the standing crop, compared with about 20 per cent of the standing crop at the northern latitude of 46 degrees.

The north-south temperature gradient gives approximately 1 F. difference for each degree of latitude (north or south). Under this regional relationship, the temperature change causes the production rate to vary, increasing or decreasing by one-third per cent (0.33) for each degree of latitude going south or north. (See Chapter 11, "Temperature - Effects on Fish.")

Streams

In accordance with Exhibits J and K, or with more precise data if available, the food potential of the subregions of streams may be evaluated. In those areas suitable for spawning, the food-producing characteristics of streams should follow closely the lower parameters delineated for trout spawning.

As shown in Exhibits L, N and O, terrestrial food normally does not represent a major part of a fish's diet and the fish are dependent on the wetted areas of a stream. Aquatic food supplies do not shift within the stream sections as stream levels rise or fall, so that the permanent wetted area of a channel, or the low flow, is the governing factor

FOOD PRODUCING AREAS

in food production. This is further substantiated by the fact that food organisms generally have at least a one-year life cycle and they do not reestablish themselves in areas that are alternately wetted and dried. The maximum food supply from flies is available in mid-spring (References 12 and 13) and they become less available as fish food when their winged stage is reached in late spring and early summer.

Within the streams, food is required for the support of body functions, and, in greater amounts (in the juvenile stage), for growth; hence, the number of pounds of fish that may be supported in an area at a given time depends on the availability of food, the weight of the fast-growing juveniles and the total pounds of the fish at or approaching adult stage, or at least at a point of decelerated growth. This is borne out by Exhibits B, E, F and H. An assumption may be made that in stable West Coast streams, where the environment is suitable, .4 yearling per square yard is supported.

Reference No. 9 shows the wet weight of individual bottom organisms, which varies between 1.0×10^{-3} and 8.0×10^{-2} grams (3.21×10^{-5} and 2.56×10^{-3} ounces), with an overall average of approximately 6.80×10^{-3} grams (2.18×10^{-4} ounces). Using the above, it may be shown that the average amount of food present in a stream throughout a year may vary from 45 to 177 pounds per acre. Reference No. 13 indicates that a stream with an average yearly standing food crop of 45 pounds per acre can produce 500 pounds of trout (plus other species) per acre per year. This means that when considering the average amount of food required for maintenance, about 1.23 per cent per day of the body weight of the fish (55 F. average temperature), plus about 4.2 pounds of natural food for every pound of fish produced (Exhibit C)), the stream and the immediate area must provide a minimum of 3,200 pounds of food per acre per year to produce 500 pounds of trout.

When normally clear streams are required to carry silt, the result is a lowered food production. (See Chapter 12, "Silt and Turbidity.")

Flood flows, or those flows above bank full capacity of a stream, may reduce the food produced in any year by channel scour, deposition of bed load material or rechannelization. The rate at which the water level in a stream rises is an important factor in channel shaping and, hence, floods of comparable magnitude but with different generation times do not produce the same stream effects. These factors probably are most relevant to streams under flood management.

Oxygen is not only a requirement for the production of food, but it affects both the feeding and growth rates of salmonoid fish. If the oxygen level drops below 50 per cent saturation, the food consumption, gain in weight and food conversion ratio all drop (Exhibit Q). To obtain the maximum use of food, lowered oxygen level, coupled with higher than normal stream temperatures, must be avoided in stream management practices.

The temperature of the environment is an important factor that affects food digestion, growth, disease incidence, aging, weight, size, swimming speed, energy requirements and feeding and foraging rates. These effects are partially shown by Exhibits A-1. In addition, it can be shown that the preferential temperature for salmonoid fish varies generally between 49 and 57 F. at 49 degrees latitude with

feeding rates decreasing at 62 F. The energy requirements and, hence, the food requirements, rise with temperature, at least doubling between 50 and 68 F. (Exhibit A and others). This is further substantiated by the oxygen demands as shown on the exhibits. At approximately 48 F. the same conditions of growth exist as at temperatures of 62 F. and they decline with falling temperatures. This is further supported by Exhibit I, which shows the hours of digestion time required for ingested foods. Exhibit H shows that, in the case of nonfeeding adult salmon, higher than normal temperatures can only result in early exhaustion of their total stored energy.

The potential production of food from various stream reaches is shown in Exhibit J, which indicates that riffle areas are the most productive. Exhibit M, which shows the standing crop in four stream test sections in Convict Creek (two parallel, repeated in series), indicates a reasonable stability in total production when lengths are measured as a straight line, although the wetted areas varied by 18 per cent. The section with the greatest velocity produced the greatest weight of food per square foot. In the final measurement of any stream, the relationship of riffles to pools must be established, as these sections respond differently to varying flow regimes.

The velocities for best food production are between 1 and 3 fps and the depths between 0.4 and 1 foot. These velocities and depths and a bed gravel size of 1.28 inches (32.5 mm) create the best conditions for food production.

Exhibit P indicates many interrelationships of food organism cycles, stream flows, time of year, temperature and condition factors. In salmon-producing streams, the maximum requirement for food occurs in the spring, the time of maximum growth and condition recovery.

Gradient affects fish production. As the gradient approaches 500 feet per mile, there is little or no production. In sluggish streams (less than 0.5 feet per mile), the production of food is reduced to about one-ninth that of large streams of moderate gradient (5 to 15 feet per mile), e.g. 100+ pounds against 900+ pounds.

Stream channel shapes are the result of high flows that have occurred over long periods of time, resulting in scour (particle movement) on the banks and bars and in the channel beds. The natural paving of stream channels remains stable and scour does not occur at average flows.

Channels vary in shape from chutes with relatively steep sides, giving a bed of rectangular shape, to channels that are trapezoidal or elliptical in shape. (See Chapter 32, "Channel Changes.")

In a stream, energy created by slope is generally dissipated by friction (water and surface contact) on the bed and bank and by internal friction. There is also loss of energy by air and by water surface friction. At low flows there may be a redistribution of the energy loss by chutes, riffles or falls entering pools. The result of this energy balance gives varying relationships for reaches that contain runs, chutes, riffles or falls. There is an overall river slope at average or bank full flows. However, at low flows, the overall slope is generally broken into shorter reaches with gradients different from the general slope of the stream.

As the effect of bed roughness varies in relation to the wetted perimeter, the widths, depths and velocities will

FOOD PRODUCING AREAS

vary. (See Chapter 7, "Spawning Criteria.")

Effective spawning and food production are both limited to flows below the annual average, and flow changes in this productive range affects a stream's capability to support fish life.

Since the beginning of the 20th century, the use of rivers has accelerated, which has altered the historical relationships of mean to low flows and mean to high flows in many streams. Diversion and storage are the principal causes of these changed relationships.

To evaluate the effects of natural river flow variations on stream flows, and thus on fish spawning and rearing, with such variations having been exacerbated by water uses, it is useful to develop an approach that will define the effects of flow variations on the width of a stream, the

average depth of the flow, and the average velocity at a cross section. An approach using power factors with multipliers is suggested. (See Chapter 7, "Spawning Criteria.")

The published papers of the United States Geological Survey give historical flow records, but do not necessarily define the alteration of flows caused by water use. Long-time records provide an excellent basis for determination of average low flows, average flows, and average high flows and generally report measured or calculated maximum flows and their time of occurrence and duration.

Slope data may be determined from various sources: Federal records; land and road surveys of states, counties, cities and irrigation districts; railroad and industrial surveys and various quadrangle maps and aerial surveys. Data on individual stream reaches may not be available and may require field examination.

FOOD PRODUCING AREAS

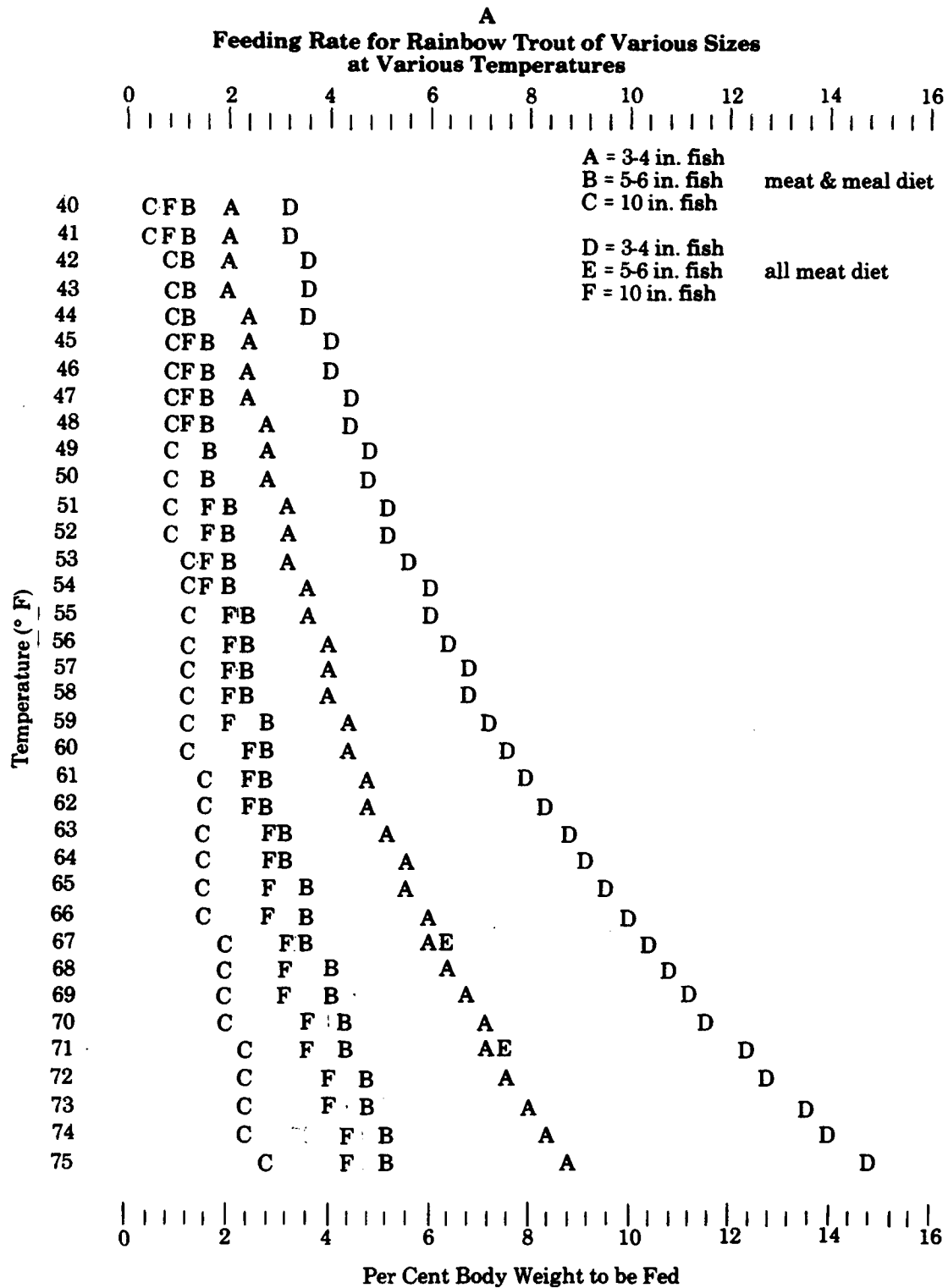

N.B. Values from 61° to 75° F are extrapolated from the experimental data.
Energy values must account for changes in tissue water content up to 20 per cent.

Prepared by Don M. Fagot - data from Reference no. 46

FOOD PRODUCING AREAS

B

Energy Requirements (in K Per Day)* Compared With Oxygen Demands

Temperature (° F)	Trout Diet in Ponds		Brett's Oxygen Requirements	
	5-6 in. fish (0.08 lbs.)	10 in. fish (0.4 lbs.)	8 in. fish (0.22 lbs.)	
41	0.56	1.33	0.3	
50	0.91	2.50	0.5	
59	1.50	3.32	0.7	*K = 1000 calories
68	2.10	5.15	0.9	Prepared by Don M. Fagot
75	2.90	7.30	1.5	from Reference nos. 40 & 46

C

Food Conversions of Salmonids

Ratio, Weight Fed to Weight Gained	Type of Food	Per cent Protein (Wet Weight)	K per lb. Food*
1.74:1	Abernathy test diet: 16.32% salmon meal 15.63% dried skim milk 10.42% cottonseed meal 7.81% wheat germ 9.61% soybean oil 2.00% vitamin mix 38.21% water	25	1070
2.7:1	Brine shrimp	11.8	336
2.9:1	50% meat and 50% meal	27.6	725
2.9:1	100% meat	18.3	415
4.9:1	Natural foods	11.5	280
6.05:1	Gammarus (amphipods)	--	--

K = 1000 calories

Prepared by Don M. Fagot from data supplied by Roger E. Burrows
(Reference no. 47)

D

Effect of Feeding of Live Minnows to Brook Trout

	Average Temperature		
	48.2° F	55.4° F	62.6° F
Weight fed per day (grams)	5.02	6.95	5.57
Weight gain per day (grams)	1.42	1.92	1.44
Per cent weight gain per day	1.46	1.99	1.49
Per cent body weight fed per day	5.19	7.2	5.75
Conversion ratio	3.61	3.64	3.90

When temperatures reached 62.6° F, feeding decreased.

At temperatures above 69.8° F, the fish only ate 0.85 per cent body weight per day.

Average weight 96.7 grams.

Adapted from Reference no. 38

FOOD PRODUCING AREAS

E

Daily Feeding Rate of Brook Trout (as Per Cent of Body Weight--All Meat Diet)

Temperature ° F	Length (Inches)						
	1	2	3	4	5	6	7
42	6.2	3.1	2.1	1.6	1.3	1.0	0.9
44	10.0	5.0	3.3	2.5	2.0	1.7	1.4
46	13.7	6.8	4.6	3.4	2.7	2.3	1.9
48	17.4	8.7	5.8	4.3	3.5	2.9	2.5
50	21.1	10.5	7.0	5.2	4.2	3.5	3.0
52	24.8	12.4	8.3	6.2	5.0	4.1	3.5
54	28.5	14.2	9.5	7.1	5.7	4.8	4.1

Expected Daily Percentage Increase in Weight

Temperature ° F	Length (Inches)						
	1	2	3	4	5	6	7
42	2.07	1.04	0.69	0.52	0.42	0.35	0.30
44	3.33	1.67	1.11	0.83	0.67	0.56	0.48
46	4.56	2.28	1.52	1.14	0.91	0.76	0.65
48	5.79	2.89	1.93	1.45	1.16	0.97	0.83
50	7.02	3.51	2.34	1.75	1.40	1.17	1.00
52	8.28	4.14	2.76	2.07	1.66	1.38	1.18
54	9.51	4.75	3.17	2.38	1.90	1.59	1.36

N.B. Values to Left and Below Lines are Extrapolated Figures.

Adapted from Reference No. 41

FOOD PRODUCING AREAS

F

Per Cent Weight Gain of Fall Chinook Fingerlings During a 28-Day Period

Bureau of Sport Fish and Wildlife Salmon Cultural
Laboratory - Longview, Washington

Water Temper- ature (° F)	Initial Weight		Final Weight		Per Cent Gain		Gain oz. per day
	grams	ounces	grams	ounces	per month	per day	
50	1.38	0.049	1.85	0.066	134	4.8	0.00060
55	1.38	0.049	2.31	0.0813	167	5.95	0.00115
60	1.38	0.049	2.62	0.0945	190	6.8	0.00162
65	1.38	0.049	2.46	0.0855	178	6.35	0.00130
50	5.78	0.204	9.12	0.322	58	2.06	0.00421
55	5.78	0.204	10.92	0.389	89	3.18	0.00675
60	5.78	0.204	12.08	0.426	109	3.90	0.00792
65	5.78	0.204	11.21	0.401	94	3.36	0.00703
50	8.85	0.311	12.92	0.451	46	1.64	0.0050
55	8.85	0.311	13.28	0.464	50	1.78	0.00546
60	8.85	0.311	15.40	0.549	74	2.64	0.00850
65	8.85	0.311	14.80	0.520	67	2.38	0.00746

Prepared by Don M. Fagot from data supplied by Roger E. Burrows
(Reference No. 47)

FOOD PRODUCING AREAS

G

Per Cent Length gain of Fall Chinook Fingerlings During a 28-Day Period

Bureau of Sport Fish and Wildlife Salmon Cultural
Laboratory - Longview, Washington

Water Temper- ature (° F)	Initial Length		Final Length		Per Cent Gain		Gain inches per day
	(mm)	(in)	(mm)	(in)	per month	per day	
50	49	1.93	54	2.13	11.05	0.3946	0.00714
55	49	1.93	58	2.28	11.80	0.4214	0.0125
60	49	1.93	61	2.40	12.42	0.4439	0.0167
65	49	1.93	59	2.32	12.00	0.4286	0.0139
50	79	3.11	92	3.62	11.60	0.4143	0.0182
55	79	3.11	98	3.86	12.45	0.4446	0.0268
60	79	3.11	101	3.98	12.80	0.4571	0.0315
65	79	3.11	99	3.90	12.54	0.4479	0.0282
50	91	3.56	103	4.06	11.30	0.4036	0.0172
55	91	3.58	104	4.09	11.40	0.4071	0.0182
60	91	3.58	110	4.33	12.10	0.4321	0.0268
65	91	3.58	108	4.25	11.85	0.4232	0.0240

Prepared by Don M. Fagot from data supplied by Roger E. Burrows (Reference no. 47)

H

Food Consumption at Various Temperatures and Sizes (Using Abernathy Soft Pellet 27.5 Per Cent Protein)

Comparison of Abernathy Soft Pellet With Two Other Types of Food

	Temperature (° F)	Per Cent Body Weight Per Day in Food Fed	Per Cent Drop in Food Feed Between Fingerlings & Adults
1.33 inches to 2.00 inches	40	3.0	--
	45	3.8	--
	50	4.8	--
	55	6.1	--
	60	7.6	--
Adults	40	0.8	62.5
	45	1.0	62.0
	50	1.5	68.0
	55	1.9	68.0
	60	2.4	68.5

Type of Food	Per Cent Protein (wet weight)	Per Cent Body Weight Gain Per Day
Abernathy soft pellet	27.5	5.4
Dry pellet	40	4.5
Meat diet	18	7.4

Prepared by Don M. Fagot from data supplied by
Roger E. Burrows, (Reference no. 47)

FOOD PRODUCING AREAS

I

**Digestion Time Required
by Trout at Various Temperatures**

**Increase in Metabolic Rate Caused
by Temperature Increase**

Food Organism (1/2 gram meal)	Hours Required for Complete Digestion at Various Temp. (F°)				Per Cent Loss Per Day	Average Daily Temperature	
	49-53	43-44	35-36	32-33		° C	F°
Helodrilus (soft bodied) (oligochaete)	12	18	25	--	0.9	7.94	46.3
Gammarus (intermediate hard ness)(amphipod)	13	18	26	43	1.1	11.3	52.3
Arctopsyche (hard bodied) (caddisfly)	16	24	44	70	1.3	14.6	58.3

Adapted from Reference no. 44

Adapted from Reference no 45

J

Per Cent Occurrence of Trout Food in Streams

Organism	Substrate			Total
	Riffle	Flat	Pool	
Trichoptera (caddisfly)	26.96	10.85	12.68	50.49
Diptera (true fly)	5.62	5.66	3.82	15.10
Ephemeroptera (mayfly)	5.32	4.56	4.35	14.23
Coleoptera (beetles)	4.82	2.11	6.26	13.19
Mollusca	1.37	0.87	3.11	5.35
Annelida (worms)	1.68	0.05	0.09	1.82
Plecoptera (stonefly)	0.26	0.02	0.02	0.30

Riffle current over 0.99 ft/sec
depth over 0.49 ft

Flat current under 1.0 ft/sec
depth under 1.25 ft

Pool current under 1.0 ft/sec
depth 1.25 to 2.44 ft

Adapted from Reference no. 12

Gross Distribution of the Aquatic Invertebrate Fauna with Water Velocity, Mean Depth, and Substrate Particle Size.

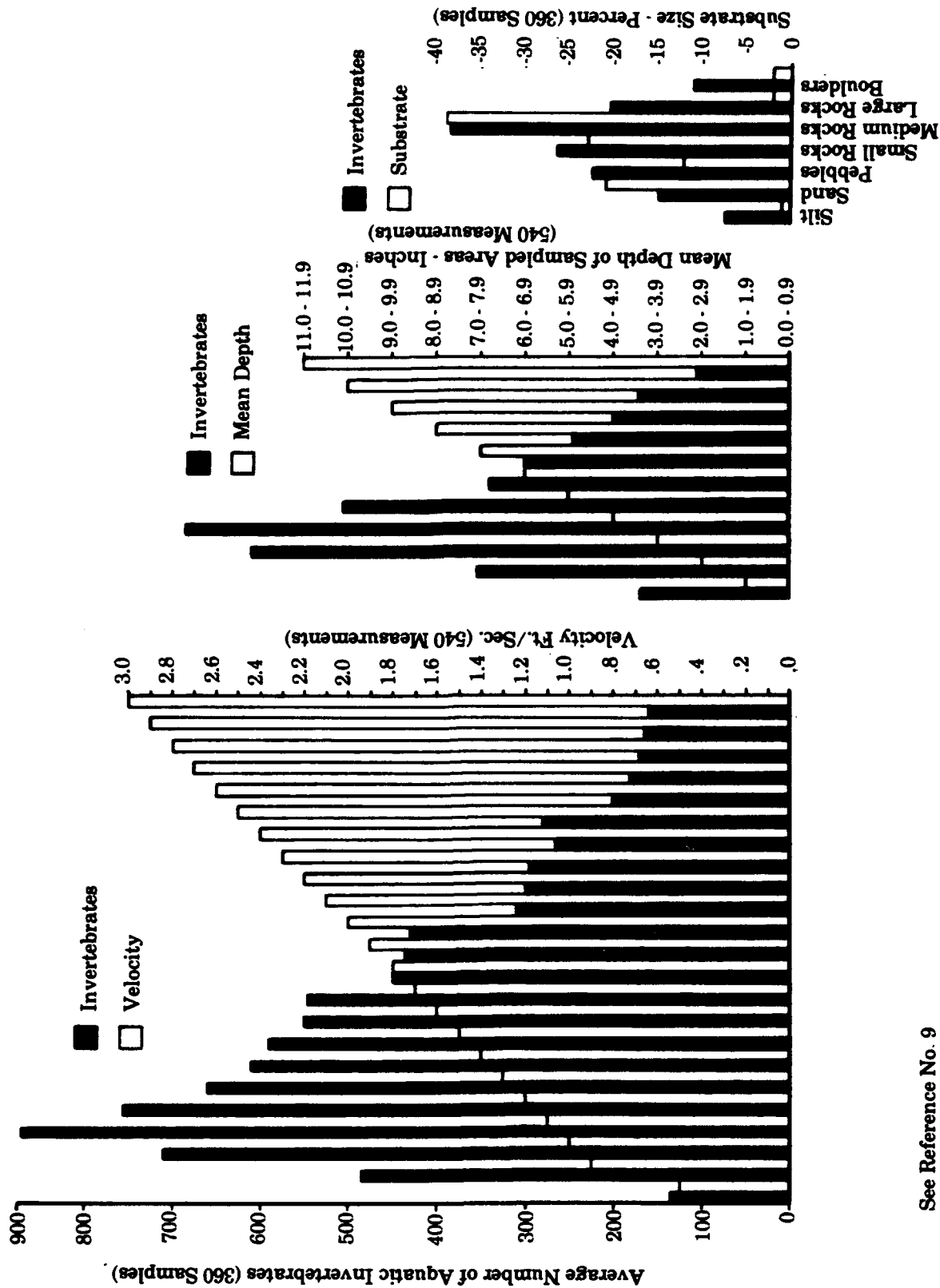

See Reference No. 9

FOOD PRODUCING AREAS

L

Abundance and Volume of the Four Dominant Orders of Aquatic Insects by Months

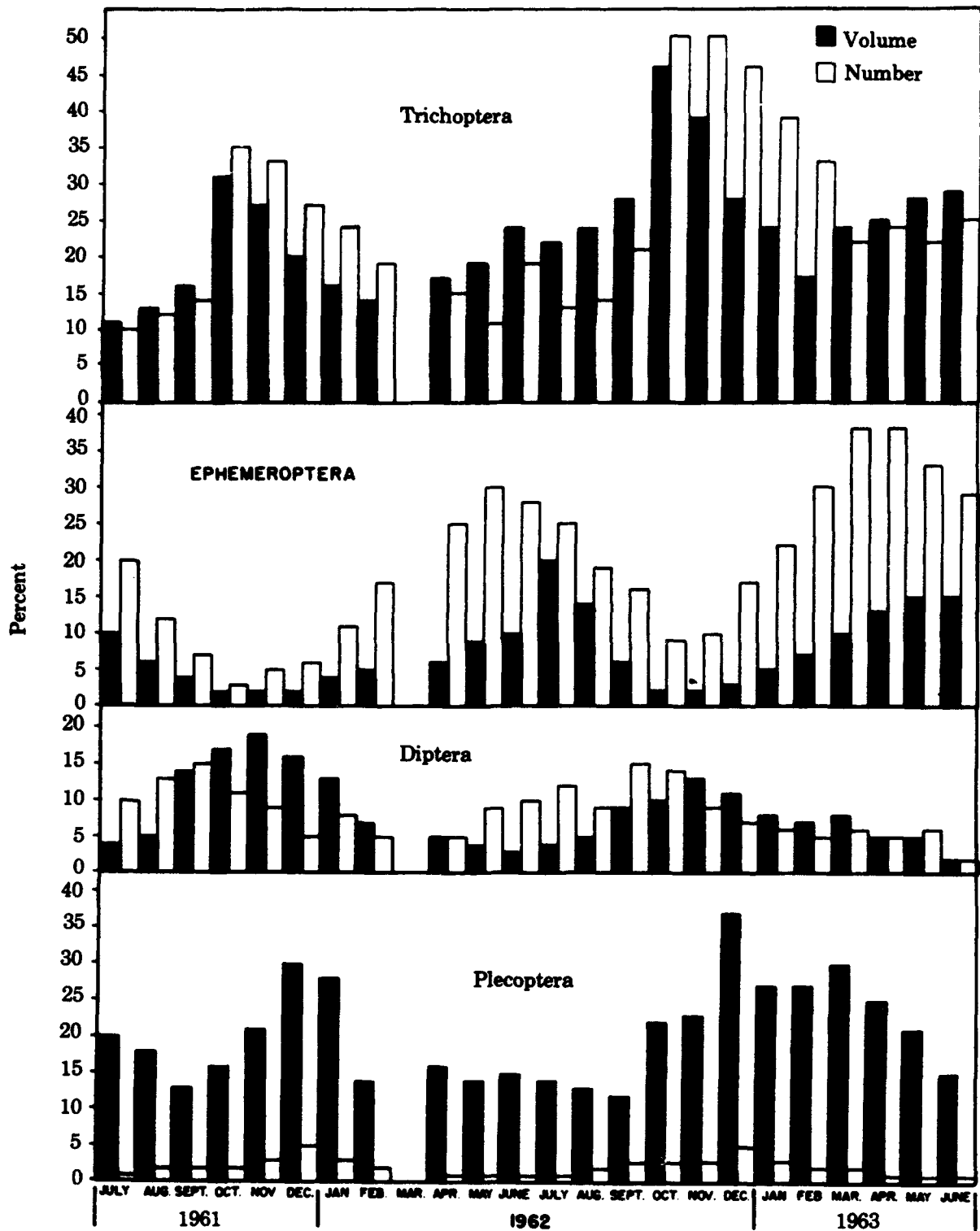

See Reference No. 9

FOOD PRODUCING AREAS

M

Average Standing Crop of Bottom Organism (No./Ft²/Mo.)

Organisms	Areas in Convict Creek					Individual Weight of Organism (Grams)	Average Total Weight Gr/Ft ²
	I	II	III	IV	Av.		
Trichoptera (caddisfly)	74	87	77	70	77	0.0082	0.630
Coleoptera (beetles)	55	74	45	59	58	0.0010	0.058
Ephemeroptera (mayfly)	59	58	47	59	56	0.0029	0.162
Oligochaeta (aquatic worm)	26	29	22	25	26	0.0126	0.328
Diptera (true fly)	18	22	20	25	21	0.0016	0.034
Plecoptera (stonefly)	5	8	5	8	7	0.0800	0.560
Misc. ¹	27	42	15	31	29	0.0026	0.075
Total	264	320	231	277	274		1.85

¹Includes mollusks, flatworms, roundworms, water mites, egg masses.

Adapted from Reference no. 9

N

Percentage Occurrence of Major Groups of Organisms in 289 Trout Stomachs

Organism	Total Number	Percent of Total Number	1962							1963				
			June	July	Aug.	Sept.	Oct.	Nov.	Dec.	Jan.	Feb.	Mar.	Apr.	May
Trichoptera	2974	25.8	43.4	24.4	11.2	9.2	15.2	21.1	36.3	43.7	22.2	25.9	11.4	55.7
Ephemeroptera	2914	25.3	21.1	14.7	16.3	11.4	5.8	13.6	29.3	35.4	43.5	47.9	40.6	32.8
Diptera	2783	24.2	11.7	32.1	41.7	39.0	39.7	28.2	27.8	11.3	27.3	14.5	21.3	2.2
Plecoptera	514	4.5	7.1	7.4	3.4	6.7	1.1	8.4	2.7	7.9	6.0	0.9	3.0	3.9
Terrestrial ¹	1940	16.9	12.9	19.3	23.4	28.1	33.9	22.1	0.0	0.0	0.0	9.1	20.5	3.3
Misc. ²	380	3.3	3.8	2.1	4.0	5.6	4.3	6.5	3.9	1.7	0.9	1.7	3.2	2.1

¹Includes Ants, Flies, Lepidopteran Larvae, Grasshoppers, and Leafhoppers.

²Includes Beetles, Oligochaetes, Mollusks, Roundworms and Water Mites.

See Reference no. 9

FOOD PRODUCING AREAS

0

**Mean Monthly Averages and Trends for
Quantity and Type of Material Ingested by Trout.**

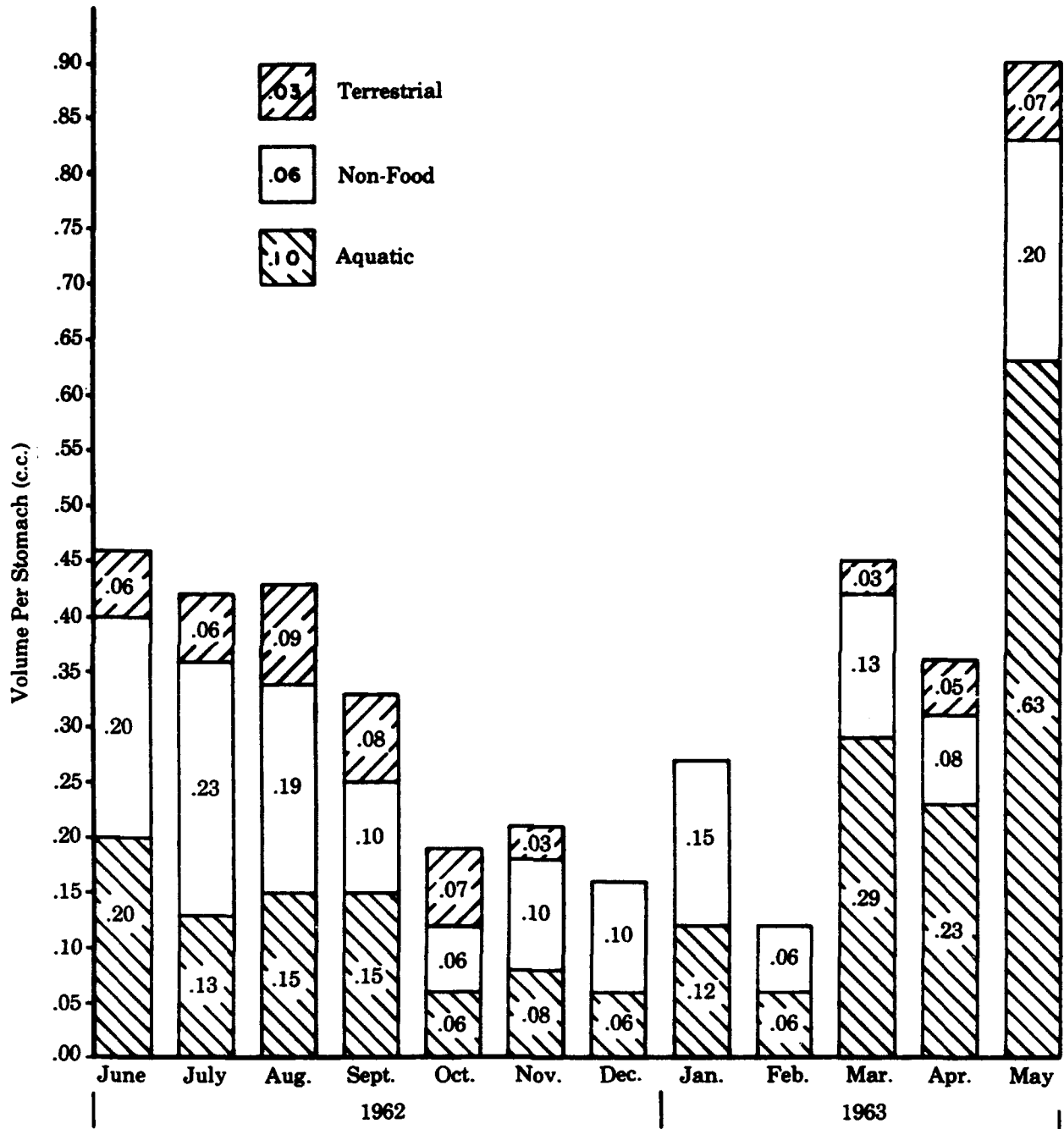

See Reference No. 9

FOOD PRODUCING AREAS

P

Condition of the Trout (K) in Relation to Utilization and Abundance of Bottom Organisms, Rate of Flow and Stream Temperature.

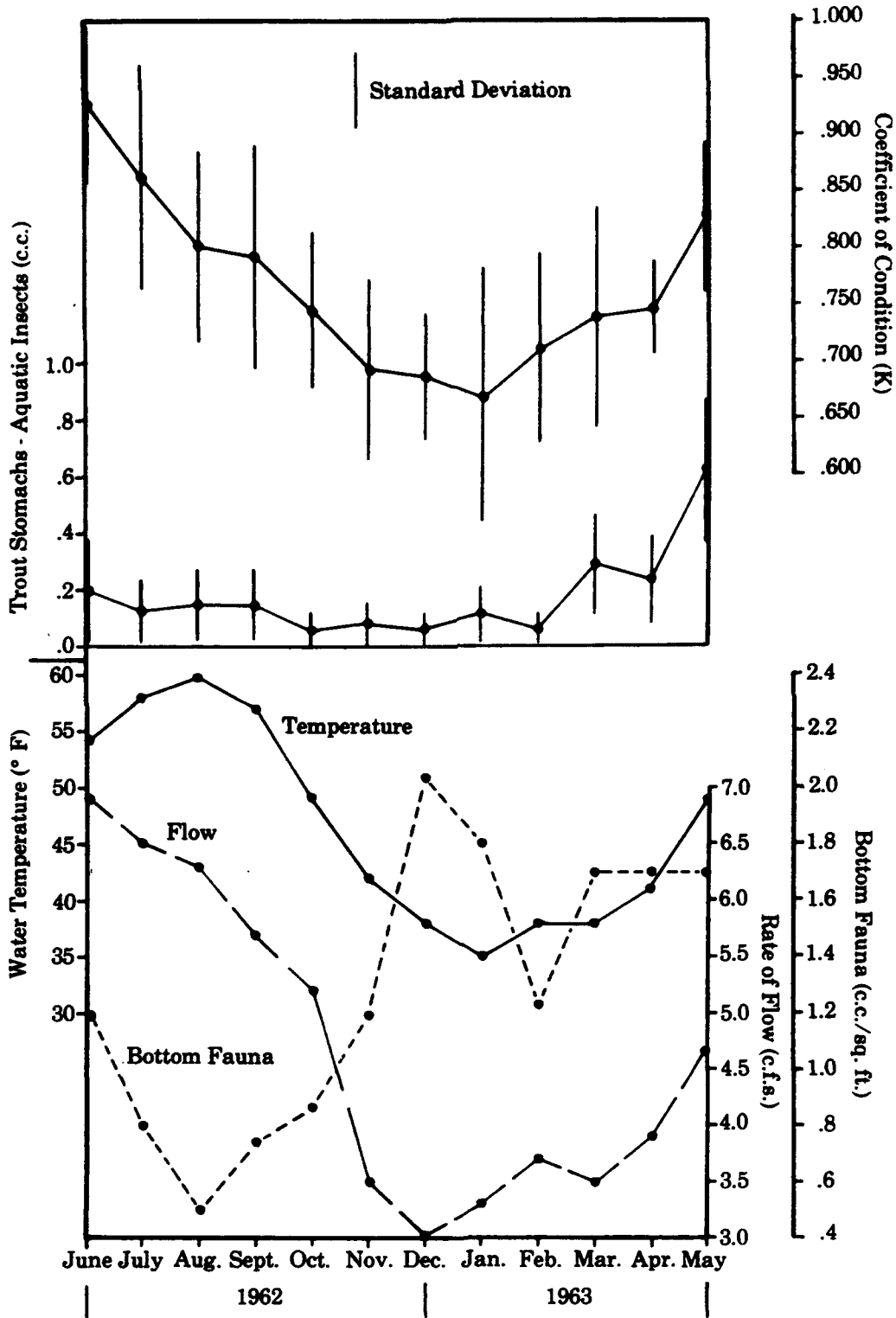

See Reference No. 9

FOOD PRODUCING AREAS

Q

Oxygen and Growth of Young Coho Salmon

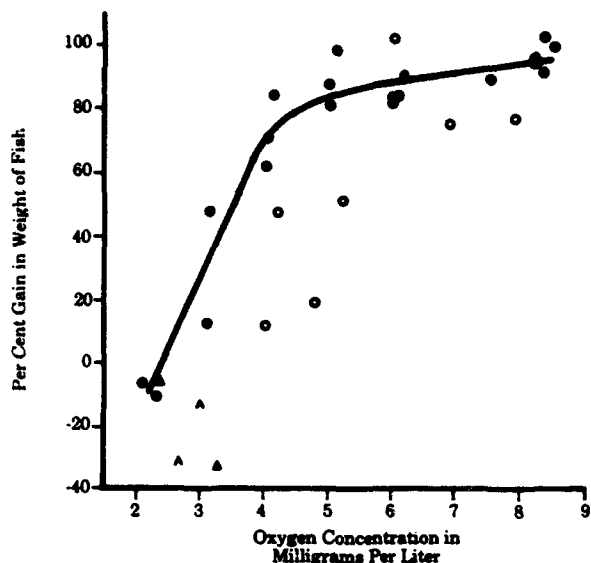

Figure 1. Weight gains (or losses) in 19 to 28 days among frequently fed age-class 0 coho, expressed as percentages of the initial weight of the fish, in relation to dissolved oxygen concentration. The curve has been fitted to the points representing results of tests performed in the year 1956 only. All of the 1956 positive weight gain values are results of 21-day tests.

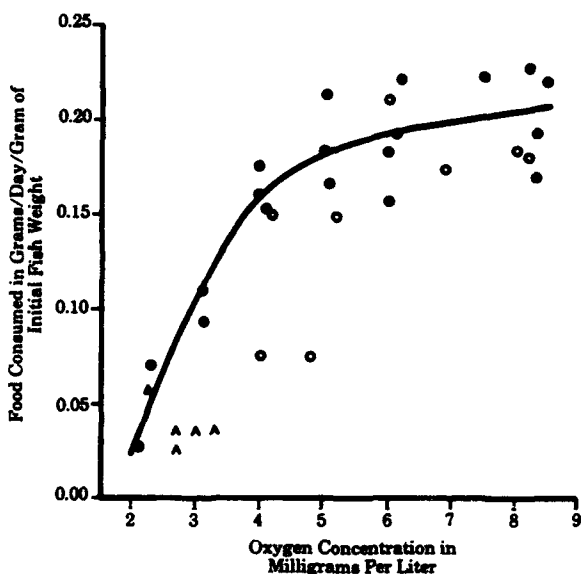

Figure 2. Grams of food (beach hoppers) consumed by frequently fed age-class 0 coho salmon per day per gram of initial weight of the fish, in relation to dissolved oxygen concentration. The curve has been fitted to the points representing the 1956 data only.

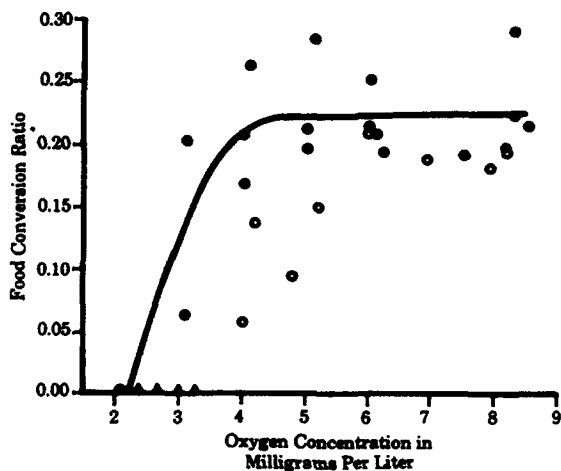

Figure 3. Food conversion ratios for frequently fed age-class 0 coho salmon, or their weight gains in grams per gram of food (beach hoppers) consumed, in relation to dissolved oxygen concentration. A food conversion ratio of zero (not a ratio having a negative value) has been assigned to each group of fish that lost weight. The curve has been fitted to the points representing the 1956 data only.

- ▲ 1956 Tests
- ▲ 1955 Tests
- Surviving Fish
- ▲▲ Only or Mostly Dying Fish

Saturation values at 20° C

2 = 22%	5 = 56%	8 = 90%
3 = 33%	6 = 68%	9 = 103%
4 = 45%	7 = 79%	

Adapted from Reference no. 34

FOOD PRODUCING AREAS

R

Rearing Characteristic Curve of Typical Stream

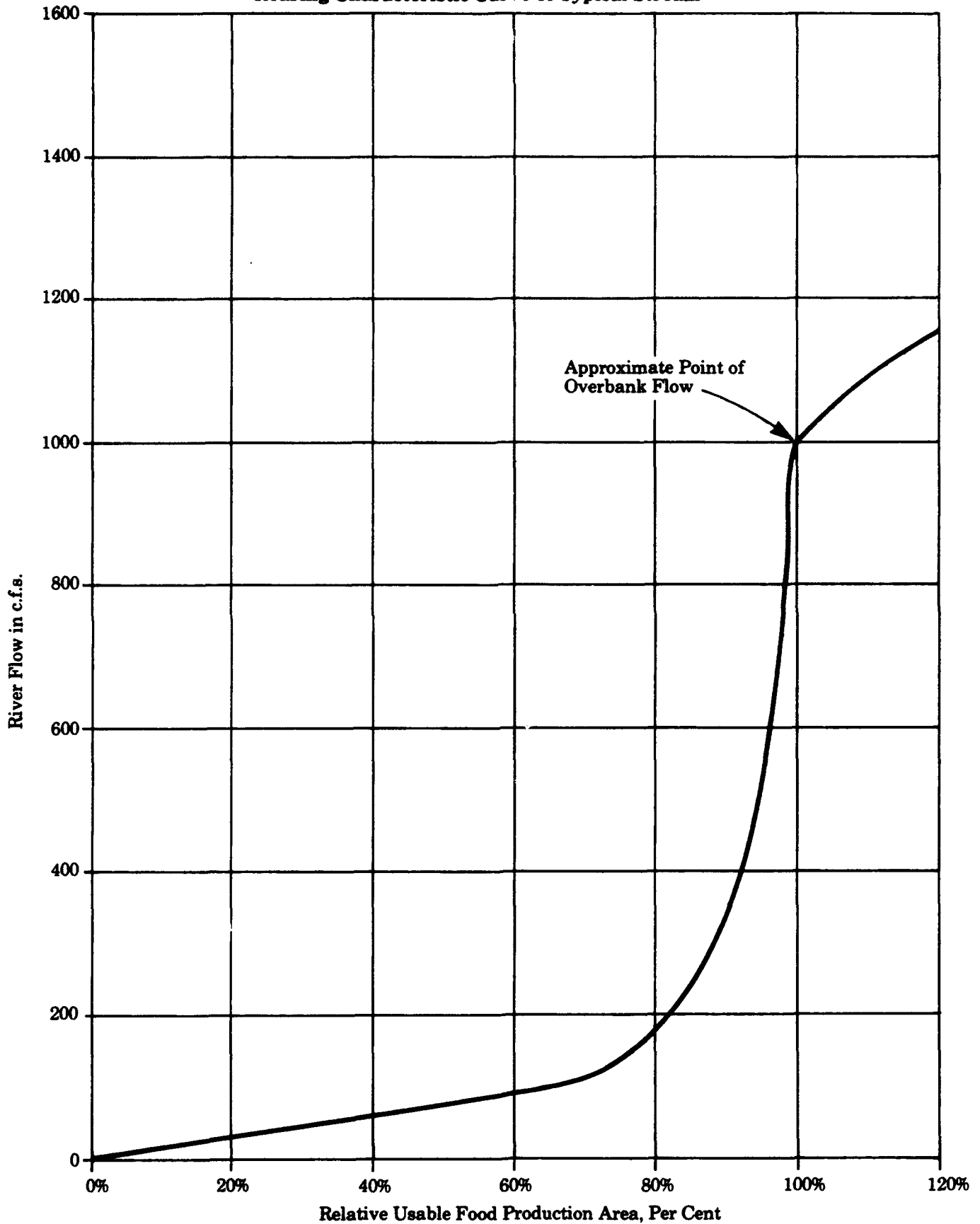

Washington State Department of Fisheries
Drawn: 12-18-67 by: J.K. Magee

FOOD PRODUCING AREAS

Average Annual Escapement (Wild and Hatchery-Reared Fish) in Selected Streams in Western Washington

Species	Nooksack-Sumas	Skagit-Samish	Stilla-quamish	Whidbey-		Cedar-Green	Puyallup	Nisqually-Deschutes	West Sound Area	Elwha-Dungeness	San Juan Area
				Camano Area	Snohomish						
Chinook	1,260	19,190	4,940	7,680	3,490	2,030	3,850	3,760	1,140		
Coho	7,410	49,290	21,200	36,440	32,480	7,570	4,890	74,460	2,540	50	
Pink	73,130	485,000	268,750	148,750		14,750	4,510	187,010	164,500		
Chum	54,860	115,940	8,400	21,150	16,680	22,200	10,730	129,340	2,560	50	
Sockeye		2,330			90,000						
Summer steelhead	70	330	1,500	1,700	90		80	750	240		
Winter steelhead	4,900	60,500	24,900	53,800	39,400	26,500	7,300	11,600	9,200		
Sea. Cut.	26,600	75,300	59,300	48,500	45,800	19,900	27,600	133,000	29,520		

Average Annual Production and Standing Crops in Selected Streams and Contiguous Lakes in Western Washington

Salmonid Production (lb./acre)	200.5	227	83.9	116	245	225	205.7	28.8	172.2	96.7
Standing Crop (lb./acre)	218 (29-770)	275 (90-690)	137.9 (70-170)	127.1	366	245.5 (107-448)	334.3 (206-378)	252.7 (200-310)	250 (144-353)	99.4 (90-100)
Total Harvest from Contiguous Lakes and Ponds (lb./acre)	50 > 10-100	150 > 10-300	50 > 10-100	150 > 10-300	150 > 10-100	100 > 10-200	50 > 10-100	150 > 10-300	150 > 10-300	25 > 10-50

These figures are intended for comparative purposes only. They show the wide variability in production that is expected under natural conditions. Extracted from reference No. 48.

FOOD PRODUCING AREAS

References

1. Rees, W.H., "Further observations of Bear Creek." In Washington Department of Fisheries, Puget Sound Investigations, March through June, 1953, Progress report, pp.91-97. Unpublished. Olympia, Washington. 1953.
2. Coche, Andre' G., "Production of juvenile steelhead trout in a freshwater impoundment." Ecological Monographs, 37(3):201-228. Summer, 1967.
3. Heg, Robert T., "Stillaguamish slide study: summary of data obtained by Research Division during 1952." Unpublished. Washington Department of Fisheries, Olympia, Washington. February 20, 1953.
4. Chapman, Wilbert McLeod and Elmer Quistorff, "The food of certain fishes of North Central Columbia River drainage, in particular young chinook salmon and steelhead trout." Washington Department of Fisheries, Biological report no. 37A. Olympia, Washington. January, 1938.
5. Tunison, A.V., and C.M. McCay, "The nutritional requirements of trout." Transactions of the American Fisheries Society, 65:359-375. 1935.
6. Waters, Brian F., "Abundance, distribution and species composition of zooplankton in the lakes of the Nushagak District, Alaska, 1961-1965." University of Washington, College of Fisheries, Fisheries Research Institute, Circular no. 67-2. Seattle, Washington, January 23, 1967.
7. Reeves, J.E., "A quantitative comparison of bottom faunas of freshwater lakes in Southwestern Alaska." University of Washington, College of Fisheries, Fisheries Research Institute, Circular no. 68-1. Seattle Washington. March 20, 1968.
8. Rawson, D.S., "Studies of the fish of Great Slave Lake." Fisheries Research Board of Canada, Journal, 8(4):207-240. October, 1951.
9. Kennedy, Harry D., "Seasonal abundance of aquatic invertebrates and their utilization by hatchery-reared rainbow trout." U.S. Fish and Wildlife Service, Bureau of Sport Fisheries and Wildlife, Technical papers no. 12. Washington, D.C. September, 1967.
10. Foerster, R.E. and W.E. Ricker, "The coho salmon of Cultus Lake and Sweltzer Creek." Fisheries Research Board of Canada, Journal, 10(6):293-319. July, 1953.
11. Rawson, D.S., "The bottom fauna of Great Slave Lake." Fisheries Research Board of Canada, Journal, 10(8):486-520. November, 1953.
12. Allen, K. Radway, "A New Zealand trout stream - some facts and figures." New Zealand Marine Department, Fisheries bulletin no. 10A. Wellington, New Zealand. 1952.
13. Allen, K. Radway, "The Horokiwi stream: a study of trout population." New Zealand Marine Department, Fisheries bulletin no. 10. Wellington, New Zealand. 1951.
14. Langbein, Walter B., and Luna B. Leopold, "Quasi-equilibrium states in channel morphology." American Journal of Science, 262(6):782-794. June, 1964.
15. Leopold, Luna B., Ralph A. Bagnold, M. Gordon Wolman, and Lucien M. Brush, Jr., "Flow resistance in sinuous or irregular channels." U.S. Geological Survey, Professional paper no. 282-D. Washington, D.C. 1960.
16. Leopold, Luna B., and Thomas Maddock, Jr., "The hydraulic geometry of stream channels and some physiographic implications." U.S. Geological Survey, Professional paper no. 252. 1953.
17. McDonald, J.G., "Distribution, growth, and survival of sockeye fry (*Oncorhynchus nerka*) produced in natural and artificial stream environments." Fisheries Research Board of Canada, Journal, 26(2):229-267. February, 1969.
18. Rounsefell, George A., "Fish production in lakes as a guide for estimating production in proposed reservoirs." Copeia, 1946, no. 1:29-40. April 30, 1946.
19. Mead, R.W., and W.L. Woodall, "Comparison of sockeye salmon fry produced by hatcheries, artificial channels and natural spawning areas." International Pacific Salmon Fisheries Commission, Progress report no. 20. New Westminster, B.C. 1968.
20. Hathaway, Edward S., "The relation of temperature to the quantity of food consumed by fishes." Ecology, 8(4):428-434. October, 1927.
21. Reimers, Norman, John A. Maciolek and Edwin P. Pister, "Limnological study of the lakes in Convict Creek Basin, Mono County, California." U.S. Fish and Wildlife Service, Fishery bulletin no. 103, (volume 56). Washington, D.C. 1955.
22. International Pacific Salmon Commission, Unpublished statistics.
23. "Nutrition of trout." New York State Conservation Department, Fisheries Research Bulletin no. 29. Albany, New York. 1965.
24. Phillips, Arthur M. Jr., et al, "The nutrition of trout." New York State Conservation Department, Fisheries Research Bulletin no. 21. Albany, New York. 1957.
25. Dunstan, William, "Variations in the depot fats of Columbia River sockeye." In "Progress report - Puget Sound Stream Studies," by W.E. Bostick, W.A. Dunstan and W.H. Rees. Washington Department of Fisheries. Unpublished. 1956.
26. Foerster, R.E., "The sockeye salmon, *Oncorhynchus nerka*." Fisheries Research Board of Canada, Bulletin no. 162:71-97. Ottawa, Canada. 1968.
27. Fowler, Laurie G., and Joe L. Banks, "Test of different components in the Abernathy salmon diet." U.S. Fish and Wildlife Service, Bureau of Sport Fisheries and Wildlife, Technical Papers no. 13. Washington, D.C. August, 1967.

FOOD PRODUCING AREAS

References Reviewed (Continued)

28. Fowler, Laurie G., J. Howard McCormick, Jr., and Allan E. Thomas, "Studies of caloric and vitamin levels of salmon diets." U.S. Fish and Wildlife Service, Bureau of Sport Fisheries and Wildlife, Technical Papers no. 6. Washington, D.C. December, 1966.
29. Wood, E.M., W.T. Yasutake, A.N. Woodall, and J.E. Halver, "The nutrition of salmonoid fishes - II. Studies on production diets." *Journal of Nutrition*, 61(4):479-488. April, 1957.
30. Halver, John E., "Nutrition of salmonoid fishes - III. Water-soluble vitamin requirements." *Journal of Nutrition*, 62(2):225-243. June, 1957.
31. Halver, John E., "Nutrition of salmonoid fishes - IV. "An amino acid test diet for chinook salmon." *Journal of Nutrition*, 62(2):245-254. June, 1957.
32. Halver, John E., Donald C. DeLong and Edwin T. Mertz, "Nutrition of salmonoid fishes - V. Classification of essential amino acids for chinook salmon." *Journal of Nutrition*, 63(1):95-105. September, 1957.
33. DeLong, Donald C., John E. Halver, and Edwin T. Mertz, "Nutrition of salmonoid fishes - VI. Protein requirements of chinook salmon at two water temperatures." *Journal of Nutrition*, 65(4):589-599. August, 1958.
34. Herrmann, R.B., C.E. Warren, and P. Doudoroff, "Influence of oxygen concentration on the growth of juvenile coho salmon." *Transactions of the American Fisheries Society*, 91(2):155-167. April 1962.
35. Fisher, Richard J., "Influence of oxygen concentration and of its diurnal fluctuations on the growth of juvenile coho salmon." M.S. thesis. Oregon State University, Corvallis, Oregon.
36. Herrmann, Robert B., "Growth of juvenile coho salmon at various concentrations of dissolved oxygen." M.S. thesis. Oregon State University, Corvallis, Oregon. 1958.
37. Olson, P.A., and R.F. Foster, "Temperature tolerance of eggs and young of Columbia River chinook salmon." *Transactions of the American Fisheries Society*, 85: 203-207. 1955.
38. Baldwin, N.S., "Food consumption and growth of brook trout at different temperatures." *Transactions of the American Fisheries Society*, 86:323-328. 1956.
39. Donaldson, Lauren R., and Fred J. Foster, "Experimental study of the effects of various water temperatures on the growth, food and utilization, and mortality rates of fingerling sockeye salmon." *Transactions of the American Fisheries Society*, 70:339-346. 1940.
40. Brett, J.R., "The swimming energetics of salmon." *Scientific American*, 213(2):80-85. August, 1965.
41. Haskell, David C., "Trout growth in hatcheries." *New York Fish and Game Journal*, 6(2):204-237. July, 1959.
42. Dollar, Alexander M., "Some principles of production planning and feeding of trout." Presented at U.S. Trout Farmers' Convention, Las Vegas, Nevada. October 8, 1964.
43. Warren, Charles E., and Dean L. Shumway, "Influence of dissolved oxygen on freshwater fishes." Progress report, September 1, 1960 through August 31, 1964. U.S. Public Health Service, Division Water Supply and Pollution Control research grant WP135. Oregon State University, Department of Fisheries and Wildlife, Corvallis, Oregon. October 1, 1964. Note: *This progress report should not be cited as a publication.*
44. Lawrence, W.M., "The effect of temperature on the weight of fasting rainbow trout fingerlings." *Transactions of the American Fisheries Society*, 70:290-296. 1940.
45. Reimers, Norman, "Some aspects of the relation between stream foods and trout survival." *California Department of Fish and Game*, 43(1):43-69. January, 1957.
46. Deuel, Charles R., and others, "The New York State fish hatchery feeding chart." *Fisheries Research Bulletin* no. 3, revised edition. New York State Conservation Department. Albany, New York. 1952.
47. Burrows, Roger E., Bureau of Sport Fisheries and Wildlife, Salmon-Cultural Laboratory, Longview, Washington. Letter to Milo C. Bell, March 7, 1969.
48. Puget Sound Task Force, "Comprehensive water resource study: appendix XI, fish and wildlife." Fish and Wildlife Technical Committee. Preliminary draft. July, 1969.
49. Robbins, Timothy W., Milton S. Topping, and Edward C. Raney, "Studies of fishes in the Muddy Run pumped storage reservoir and connecting waters: a summary." Unpublished. Prepared for submission to Federal Power Commission. Ichthyological Associates, Miscellaneous report no. 4. Hollywood, Pa. May 1, 1970.
50. Murray, A. Keith, and Paul E. Fields, "Response of steelhead trout (*Salmo gairdnerii*) to continuous fixed interval and fixed ratio reinforcement schedules." Unpublished Technical Report 45. School of Fisheries, University of Washington, Seattle. September, 1957.
51. Fowler, Laurie G., and Roger E. Burrows, "The Abernathy salmon diet." *The Progressive Fish-Culturist*, 33(2):67-75. April, 1971.
52. Hunt, P.C., and J.W. Jones, "The food of brown trout in Llyn Alaw, Anglesey, North Wales." *Journal of Fish Biology*, 4(2):333-352. April, 1972.
53. Hunt, P.C., and J.W. Jones, "The effect of water level fluctuations on a littoral fauna." *Journal of Fish Biology*, 4(3):385-394. July, 1972.
54. Hunt, P.C., and J.W. Jones, "The littoral fauna of Llyn Celyn, North Wales." *Journal of Fish Biology*, 4(2):321-331. April, 1972.

FOOD PRODUCING AREAS

References Reviewed (Continued)

55. Hunt, P.C., and J.W. Jones, "The profundal fauna of Lyn Tegid, North Wales." *Journal of Zoology, London*, 168(1):9-49. September, 1972.
56. Hunt, P.D., and K. O'Hara, "Overwinter feeding in rainbow trout." *Journal of Fish Biology*, 5(2):277-280. March, 1973.
57. Bennett, George W., "Management of artificial lakes and ponds." Reinhold Publishing Corporation, New York. 1962. 283 pp.
58. Brett, J.R., and C. Groot, "Some aspects of olfactory and visual responses in Pacific salmon." *Fisheries Research Board of Canada, Journal*, 20(2):287-303. March, 1963.

Chapter 9

Effects of Fishing Pressure

Undisturbed fish populations in confined areas reduced when subjected to continued fishing pressure.

Frequently maximum size limit imposed.

Net mesh size exercises selective action on size of fish caught.

Mesh size may also affect sex ratio of salmon escapement.

Timing of runs.

Escapement must take into account natural attrition or unnatural hazards to which fish are subjected.

Injuries by net fishery may cause mortalities.

Intensive fishery may result in minor delay to movement of fish.

Plantings over many years may cause genetic changes.

Regulation changes that allow for large escapement by time period closures result in waves of fish approaching fish facilities.

Result of extensive fishing for single species in mixed fisheries.

EFFECTS OF FISH PRESSURE

Undisturbed fish populations in confined areas normally include a number of large, old individuals. When such fish populations are subjected to continued fishing pressure, either commercial or sport, there is a tendency for these numbers to be reduced. Ultimately, this may result in the deposition of too few eggs to maintain the catch. This is recognized by fishery managers, and frequently a maximum size limit is imposed for protection of the brood stock. Examples are regulations in the McKenzie River for rainbow trout and in the Columbia River for sturgeon.

The population of anadromous fish, particularly Pacific salmon and steelhead, are affected by the fact that the bulk of the upstream runs may be dominated by one or two age groups for each species, which causes variance in the length of time that returning adults are exposed to a fishery.

There is no doubt that net mesh size exercises a selective action on the size of the fish caught. In practice, mesh sizes may be changed to permit escapement of smaller fish or to limit the take of one species while permitting the take of another. It is also to be expected that this would have some genetic effect if practiced over many cycles.

Mesh size also may affect the sex ratio of the salmon escapement as male chinook salmon usually are larger than the females and have a more pronounced head and jaw structure, or "kipe," which renders them more vulnerable. In a hook and line fishery, hook size is utilized as one means of controlling size of fish taken. As the fish approach maturity, they undergo a body shape change, making them more vulnerable to nets. This is particularly pronounced in pink salmon.

Another phenomenon associated with fishing pressure is in the timing of runs. A commercial fishing season that

concentrates on the early or late segment of a run may cause, over a period of years, a shift of the run towards an earlier or later period.

It has been noted repeatedly that the largest returns do not necessarily result from the largest escapements. The escapement should be sufficient to make optimum use of available natural spawning areas or to supply parent hatcheries with an adequate return of spawners. It appears logical that when the fish must migrate long distances, or remain in fresh water for long periods of time, the escapement must take into account the natural attrition or unnatural hazards to which the fish are subjected and which cause loss.

Injuries to fish by a net fishery are noted and may cause mortalities by increasing the incidence of fungus, resulting from the loss of protective slime or from abrasion.

It has been reported that an intensive fishery may result in a minor delay to the movement of fish. Intensive hook and line fisheries for trout usually result in the need of artificial augmentation by planting. Such planting over many years may cause genetic changes in the resident species or the substitution of one species for another.

Regulation changes that allow for large escapement by time period closures result in waves of fish approaching fish facilities, and this factor must be considered in the sizing and operation of such facilities, as these waves may represent the bulk of the escapement and should be handled without delay.

In mixed fisheries, extensive fishing for a single species may result in an incidental catch of other desirable species, causing those species to be overfished.

Chapter 10

Water Quality

Dissolved oxygen criteria.

pH value.

pH influence on toxicity of dissolved materials.

Fish in acid vs. alkaline waters.

Controlled use of phosphates and nitrates.

Oil spills.

Acid rain.

References Reviewed.

WATER QUALITY

Many elements and chemical compounds in waste products of industry and agriculture and from sanitary sewers create toxic conditions for fish. See Chapter 13, "Toxicities of Elements and Compounds."

Many of the normal criteria of water quality reflect overall toxic conditions, and the accepted parameters of these indicators may need reappraisal, particularly when they occur simultaneously or when oxygen is at levels less than 5 ppm.

The accepted minimum level for dissolved oxygen (DO) has been stated to be 5 ppm. It has been demonstrated, however, that for the most successful incubation of salmon and trout eggs, the DO should be near saturation level. In Reference No. 1, it is stated that adequate growth, embryonic development and fish activity can be limited by a reduction of DO only slightly below the saturation limit. DO criteria should be based on considerations other than those of survival. For the cold-water biota, it is desirable that DO concentrations be at or near saturation. This is especially important in spawning areas where DO levels must not be below 7 ppm at any time. See Chapter 6, "Swimming Speeds of Adult and Juvenile Fish," for oxygen effects.

There is no optimum pH value for fish in general; however, in waters where good fish food exists, the pH usually is found to be between 6.7 and 8.3. In Reference No. 22, it is stated that the permissible range of pH for fish depends on many factors such as temperature, dissolved oxygen, prior acclimatization, and the content of various anions and cations. The tolerance of fish to low concentrations of dissolved oxygen varies markedly with pH.

In Reference No. 3, it is stated that the toxicity of sodium sulfide increases as the pH decreases and sulfide (S^{2-}) and bisulfide (HS^-) ions are converted into toxic hydrogen sulfide.

The pH level also influences the toxicity of dissolved materials, as cyanide and ammonia, and metallic salts, as copper sulfate, as these are less toxic in more alkaline waters.

A pH reading of 7 denotes neutral, pH readings below are on the acid side and pH readings above are on the alkaline side.

In Reference No. 3, it is stated that many species of fish can live in acid water, but it appears that under these conditions the fish may grow more slowly and fail to attain the same size as other individuals of the same species that live in alkaline streams.

Species or races of fish that are adapted to alkaline waters fail to do well and often die when transplanted to slightly

acid waters. The reason for this failure to adjust to a different pH is not fully understood, but has been observed by fish culturists and investigators for many years.

Silt and turbidity are factors in water quality. See Chapter 12, "Silt and Turbidity."

Heat (or its absence) in water is considered thermal pollution.

The introduction of phosphates and nitrates should be discouraged unless under tightly controlled conditions, as large blooms of offensive algae may result in the reduction or depletion of oxygen supplies or the creation of offensive tastes and odors. Water supersaturated by nitrogen may result in the death of fish. For recommended levels, see Chapter 13, "Toxicities of Elements and Compounds."

The hazards of oil spills are increasing. Pen rearing is accelerating and will intensify the damage of a spill if the facility is within the spill's circulation pattern or spread.

The clean-up of oil spills is complex and may be hampered by non-preparedness. Clean-up responsibility is also divided among agencies and this may result in inadequate regulations and enforcement. Time is an important factor in the control of spills.

The effects of a spill are influenced by the density of the fractions within the spill and the life of its toxicity. Local requirements should be known in developing clean-up procedures. Sensitive areas, such as fish spawning and feeding areas and water intakes, should be given particular attention. Local temperatures should be known and charted. The pollution of beaches may extend over a long period of time.

Acid rain has become a problem in the United States and an international problem, as it affects Canadian waters.

Emission of sulfur dioxide (SO_2) and nitrogen oxides (NO_x) are transmitted through the atmosphere and react in complex ways to form sulfuric acid and nitric acid.

In Northeast United States, estimates are that as much acidic material is deposited from the atmosphere by dry deposition as by wet deposition.

The total acidity of acid rain is approximately 70 percent SO_2 and 30 percent NO_x . Utilities, industrial, commercial and residential supply over 68 percent of the 70 percent (SO_2) with transportation making up the balance. Utilities, industrial, commercial and residential supply almost 18 percent of the 30 percent (NO_x) with transportation supplying the balance.

See also Chapter 15, "Plastics," and Chapter 16, "Pesticides and Herbicides," for use limitations.

WATER QUALITY

References Reviewed

1. Katz, Max Albert K. Sparks, Gary L. Pederson, C.E. Woelke, and James Woodey, "Water quality and DO requirements of fish." In "A Review of the Literature of 1967 on Wastewater and Water Pollution Control." Water Pollution Control Federation Journal, 40(6): 1008-1009. June, 1968.
2. Eicher, George J., "Problems in fish passage at true reservoirs." Unpublished report. Portland General Electric Co., Portland, Oregon.
3. Jones, J.R. Ericksen, "Fish and river pollution." Butterworths, London. 1964.
4. Langbein, W.B., and W.H. Durum, "The aeration capacity of streams." U.S. Geological survey, Circular No. 542, Washington, D.C. 1967.
5. Elliott, Joseph W., "The oxygen requirements of chinook salmon." The Progressive Fish-Culturist, 31(2): 67-73. April, 1969.
6. Davison, Robert C., Wilbur P. Breese, Charles E. Warren, and Peter Doudoroff, "Experiments on the dissolved oxygen requirements of cold-water fishes." Sewage and Industrial Wastes, 31(8):950-966. August, 1959.
7. Dorfman, D., and W.R. Whitworth, "Effects of fluctuations of lead, temperature, and dissolved oxygen on the growth of brook trout." Fisheries Research Board of Canada Journal, 26(9):2493-2501. September, 1969.
8. U.S. Geological Survey, and others, "Water quality records in Oregon." U.S. Geological Survey, Water Resources Division, Quality of Water Branch, Portland, Oregon. 1964.
9. U.S. Geological Survey, and others, "Water resources data for Oregon, Part 2. Water quality records." U.S. Geological Survey, Water Resources Division, Portland, Oregon. Annual publication.
10. American Fisheries Society, "A symposium on water quality criteria to protect aquatic life." Special publication No. 4. (Supplement to Transactions of the American Fisheries Society, 96(1).) 1967.
11. California Department of Fish and Game, and Department of Water Resources, "Delta Fish and Wildlife Protection Study." Report 7. "Water development and the delta environments." Sacramento, California. December, 1967.
12. Affleck, R.J., "The effect of galvanized iron pipes on water in a trout hatchery." Australian Journal of Science, 14:131. 1952.
13. U.S. Robert A. Taft Sanitary and Engineering Center, "Biological problems in water pollution." Compiled by C.M. Tarzwell. Transactions of the Second Seminar on Biological Problems in Water Pollution, held April 20-24, 1959. Cincinnati, Ohio. 1960.
14. Pacific Gas and Electric Company, Department of Engineering Research, "Thermal effects and other considerations at steam electric plants: a survey of studies in marine environment." Unpublished report No. 6934.4-68 submitted by J.R. Adams. August 20, 1968.
15. Klein, Louis, "River pollution II - causes and effects," with chapters by J.R. Ericksen Jones and H.A. Hawkes, and a section by A.L. Downing. Butterworths, London. 1962.
16. Orsi, James J., comp., "Dissolved oxygen requirements of fish and invertebrates." In California Department of Fish and Game, "Delta...study," Report 6, Chapter IV, pp. 48-68. June 1967.
17. National Research Council, "International critical tables of numerical data, physics, chemistry and technology," Vol. III, p. 258. McGraw-Hill, New York. 1928.
18. Sams, Roy E., and Kelly R. Conover, "Water quality and the migration of fall salmon in the lower Willamette River." Unpublished final report. Oregon Fish Commission, Salem, Oregon. May, 1969.
19. U.S. Bureau of Commercial Fisheries, Fish-Passage Research Program, "Summary: surveys of nitrogen gas saturation level in the Columbia River, June 1965-August 1, 1966." Unpublished report by Wesley J. Ebel, pp. 1-7. Seattle, Washington. August 29, 1966.
20. Sylvester, Robert O., and Carl A. Rambow, "Water quality of the state of Washington." Volume IV of "An Initial Study of the Water Resources of the State of Washington." Washington State Water Research Center, Pullman, Washington. 1967.
21. Herrmann, Robert B., "Growth of juvenile coho salmon at various concentrations of dissolved oxygen." MS thesis. Oregon State University, Corvallis, Oregon. 1958.
22. McKee, Jack Edward, and Harold W. Wolf, "Water quality criteria." California State Water Quality Control Board, Publication 3-A. Second Edition. Sacramento, California. 1963.
23. U.S. Federal Water Pollution Control Administration, "Water quality criteria: report of the National Technical Advisory Committee to the Secretary of the Interior." Washington, D.C. April 1, 1968.
24. McNeil, William J., "Environmental factors affecting survival of young salmon in spawning beds and their possible relation to logging." U.S. Fish and Wildlife Service, Bureau of Commercial Fisheries, Manuscript Report No. 64-1. Washington, D.C. April, 1964.
25. Sylvester, Robert O., "Research of investigation on the quality of water of the Columbia River and effects on the fisheries resources." U.S. Fish and Wildlife Service, Contract No. 14-19-008-2149. Seattle, Washington. January 20, 1957.

WATER QUALITY

References Reviewed (Continued)

26. Washington State Water Research Center, "A first estimate of future demands for water in the State of Washington." Report No. 2, Volume 1 of its "An Initial Study of the Water Resources of the State of Washington." Washington State University, Pullman, Washington. February, 1967.
27. Warren, Charles E., and Dean L. Shumway, "Influence of dissolved oxygen on freshwater fishes." Progress report, September 1, 1960 through August 31, 1964. U.S. Public Health Service, Division Water Supply and Pollution Control Research Grant WP 135. Oregon State University, Department of Fisheries and Wildlife, Corvallis, Oregon. October 1, 1964. (*This material has been reviewed but the results have not been cited, in accordance with the authors' request.*)
28. Washington State Department of Fisheries, "Toxic effects of organic and inorganic pollutants on young salmon and trout." Research Bulletin 5. Olympia. September, 1960.
29. Search. "Acid from the atmosphere: recent findings." 21(2). General Motors Research Laboratories. Warren, Michigan. March-April, 1966.
30. Waiwood, K.G., and F.W.H. Beamish, "Effects of copper, pH and hardness on the critical swimming performance of rainbow trout (*Salmo gairdneri Richardson*)." Water Research, 12:611-619. Pergamon Press, Ltd. 1978.
31. Environmental Protection Agency, "Columbia River thermal effects study - volume 1: Biological effects studies." In cooperation with the Atomic Energy Commission and the National Marine Fisheries Service. Portland, Oregon. January, 1971.

Chapter 11

Temperature - Effects on Fish

Fish adjust to optimum upper and lower levels under natural environmental changes.

Populations are depressed by shifts away from optimum ranges.

Adults (cold-water species) may die unspawned if subjected to high temperatures for long periods.

Mortalities occur during tender stage of egg if temperatures vary (up or down) from upper or lower tolerance range.

Growth of young related to temperature.

Disease organisms respond to temperature.

Heat shock.

Nitrogen embolism and oxygen deficiencies caused by temperature.

Swimming speeds affected by temperature.

Fish sense temperature differential of less than .5 F.

Latitude and fish residence.

Abbreviations used in exhibits.

A. Commercial Species - Optimum Range.

B. Commercial Species - Migration Range.

C. Commercial Species - General Spawning Range.

D. Commercial Species - Hatching Range.

E. Sportfish - Optimum Range.

F. Sportfish - Spawning Range.

G. Sportfish - Hatching Range.

H. Miscellaneous Species - Optimum Range.

I. Miscellaneous Species - Spawning Range.

J. Miscellaneous Species - Hatching Range.

K. Energy Requirements (in K Per Day*) Compared With Oxygen Demands.

L. Digestion Time Required by Trout at Various Temperatures. Increase in Metabolic Rate Caused by Temperature Increase.

M. Maximum Sustained Cruising of Sockeye and Coho Underyearlings in Relation to Temperature.

References Reviewed.

TEMPERATURE - Effects on Fish

Natural environmental temperature changes impose stresses on fish populations. Over many years, various species and subspecies have adjusted to upper and lower levels, within which are optimum ranges. It has been recorded in the literature that species of fish that encounter wide ranges of environmental conditions in subregions because of geographic factors adjust their optimum temperature levels within their total range by adjusting to the average annual temperature of the subregion. Exhibits A to J show ranges for fish common to the Pacific Coast regions.

When natural or artificial phenomena cause shifts away from optimum ranges, the populations are depressed. Under natural cyclic conditions stressing is not usually repeated in successive years.

It has been found that adults of the cold-water species may die unspawned if they are subjected to higher than normal temperatures for long periods of time. This is discussed in Chapter 7, "Spawning Criteria." As fish are cold-blooded animals, their metabolism rate rises with temperature. Adult fish have been known to cease migrating when subjected to extreme temperatures, approaching the upper limit shown on Exhibit B.

In 1941, sockeye salmon moved to cooler temperature streams not normally used by sockeye, when the Columbia River temperatures reached and exceeded 70 F.

Spawning may cease if the temperature drops to a level that is near or below the lower tolerance range.

During the egg's tender stage (the first half of the incubation period), temperatures that are elevated or lowered from the upper or lower tolerance range result in increased mortalities, and a sudden raising or lowering of temperatures during this stage can cause excessive mortalities.

Growth of the young is also related to temperature levels as discussed in Chapter 8, "Food Producing Areas." Generally, all cold-water fish cease growing at temperatures above 68 F. because of the increased metabolic rate. This is shown in Chapter 8, "Food Producing Areas."

The warm-water species respond generally to the same temperature pattern as the cold-water species, or in accordance with the levels shown on Exhibits H, I and J.

Beneficial effects may be realized by increasing temperatures during normally cold months, and two years' growth may be realized in one year by the use of this method.

Disease organisms also respond to temperature, causing excessive losses to fish life. Various diseases and their triggering temperature ranges are discussed in Chapter 21, "Fish Diseases - Types, Causes and Remedies." Generally, the triggering level is below or above the lower or upper tolerance level.

It is known that fish suffer heat shock when brought rapidly from lower to higher temperatures, and this phenomenon can result in loss of equilibrium. Acclimation time is important in the handling of fish as it affects their equilibrium, swimming speed and metabolism. This is shown on Exhibits K, L and M. Before the lethal limit is reached, the condition of heat shock occurs. (See Reference No. 47.)

As temperature affects the gas equilibrium in water, a nitrogen embolism can be caused and oxygen deficiencies created.

Heat has a synergistic effect and must be considered when measuring other stresses within the environment.

Swimming speeds are altered by both temperature and oxygen, and the levels must be considered in the design of facilities for handling, passing, diverting or holding fish.

Fish are capable of sensing a temperature differential of less than .5 F. Nothing is recorded to indicate why fish choose to enter areas of temperature higher than their optimum levels or to show that they actively and immediately avoid high temperatures. The evidence indicates that they do not necessarily move away from high temperature areas (and this is particularly true of warm-water fish) until the temperature reaches their upper tolerance level. Acclimation and genetic adaptation may be factors in this phenomenon.

Within their genetic tolerance, fish may reside in temperatures both north and south of the shown optimum range. In salmonoid areas, for every degree of latitude there is approximately one degree of change in the fish's preferred temperature. Thus, fish in the northern range would function more efficiently at the cold end of their tolerance range and fish in the southern range would function more efficiently at the warm end of their tolerance range.

Other modifiers of sun-created land and water temperature changes are the area's proximity to a large body of salt or fresh water and the area's altitude above sea level.

The following exhibits (A-J) were developed for latitudes 49-50 degrees.

ABBREVIATIONS USED

Symbol	Meaning
A	adults
ACC	acclimated
AR	all races
AV	avoid
D	delayed
F	fry
FA	fall Chinook
IA	inactive
J	juveniles
LL	lower lethal
LT	lower threshold
M	mortality
OPT	optimum
P	preferred
PG	poor growth
SP	spring Chinook
SU	summer Chinook
T	toleration
UL	upper lethal
UT	upper tolerance

Combine terms as follows:

P-F	preferred for fry
A-M	adult mortality

TEMPERATURE - Effects on Fish

A Commercial Species - Optimum Range

Temperature ° F

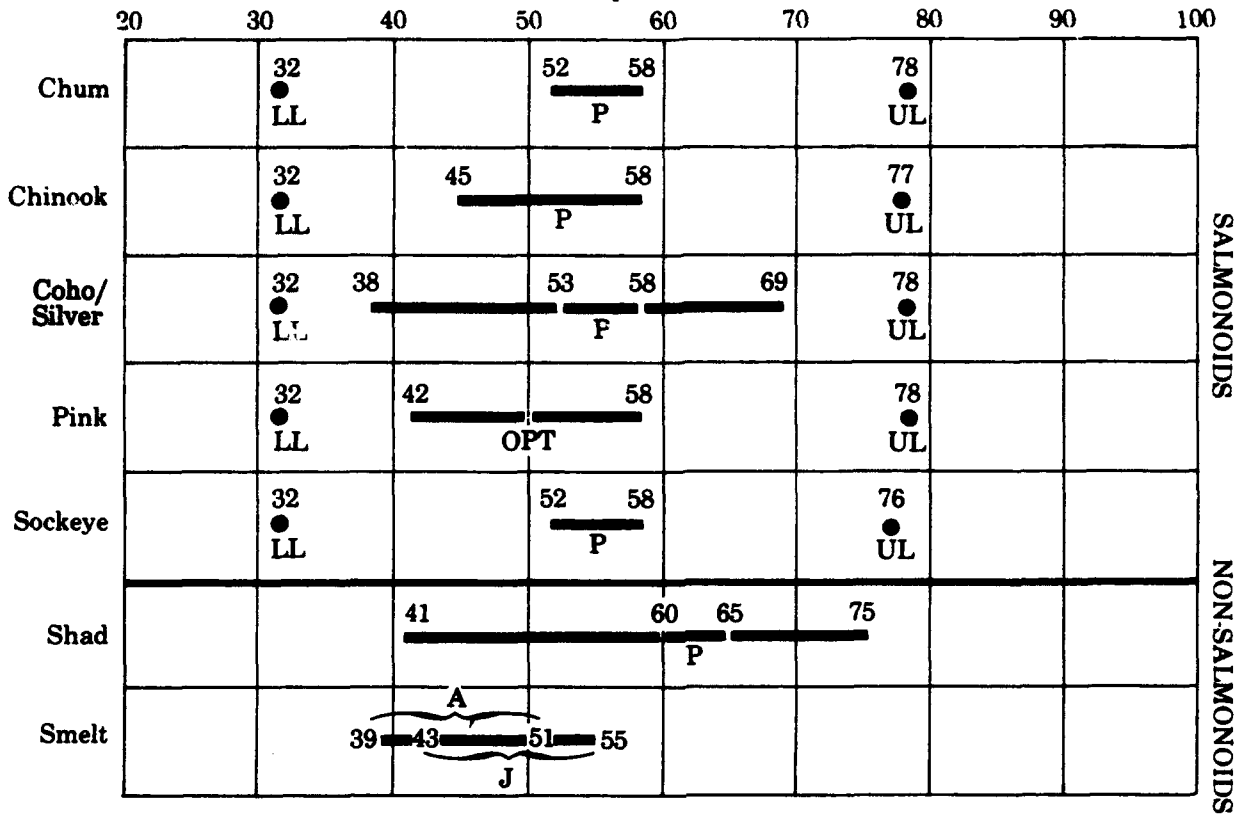

SALMONOIDS

NON-SALMONOIDS

B Commercial Species - Migration Range

Temperature ° F

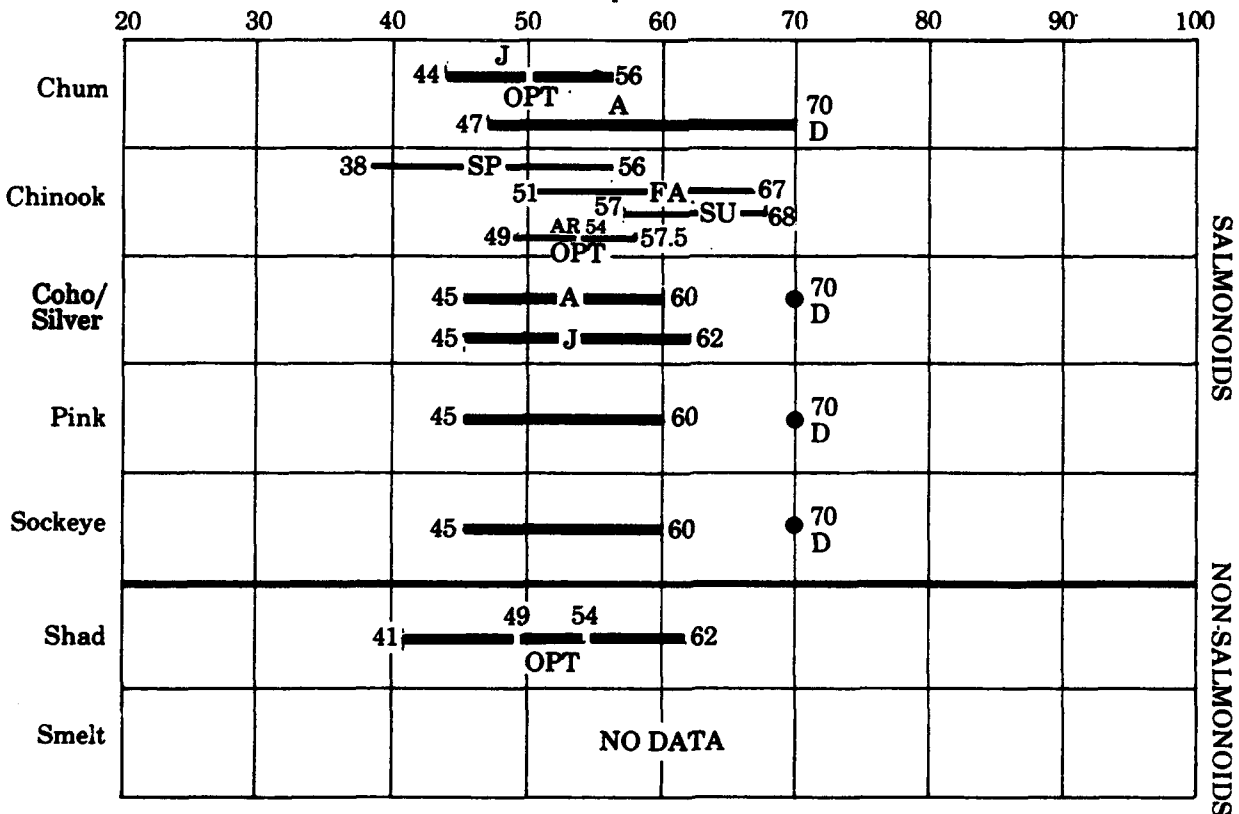

SALMONOIDS

NON-SALMONOIDS

TEMPERATURE - Effects on Fish

**C
Commercial Species - General Spawning Range**

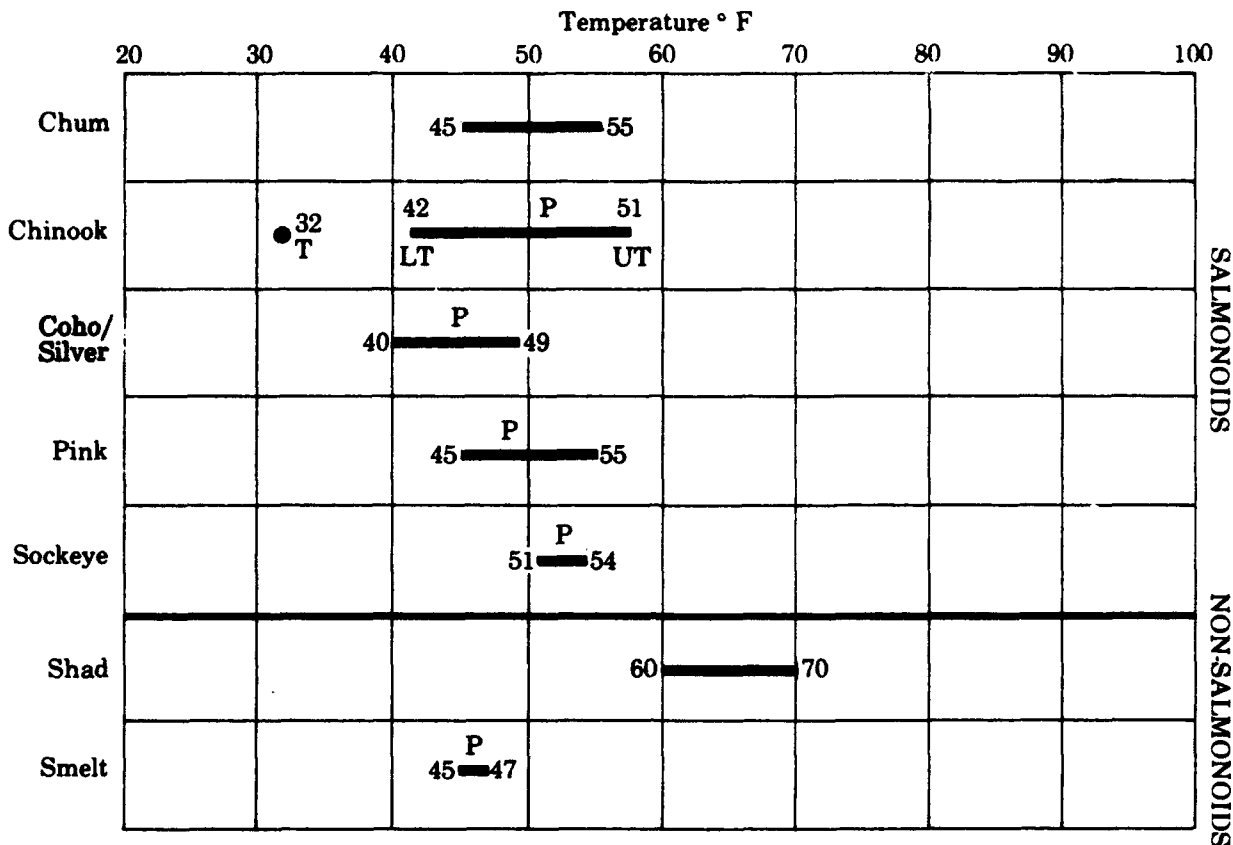

**D
Commercial Species - Hatching Range**

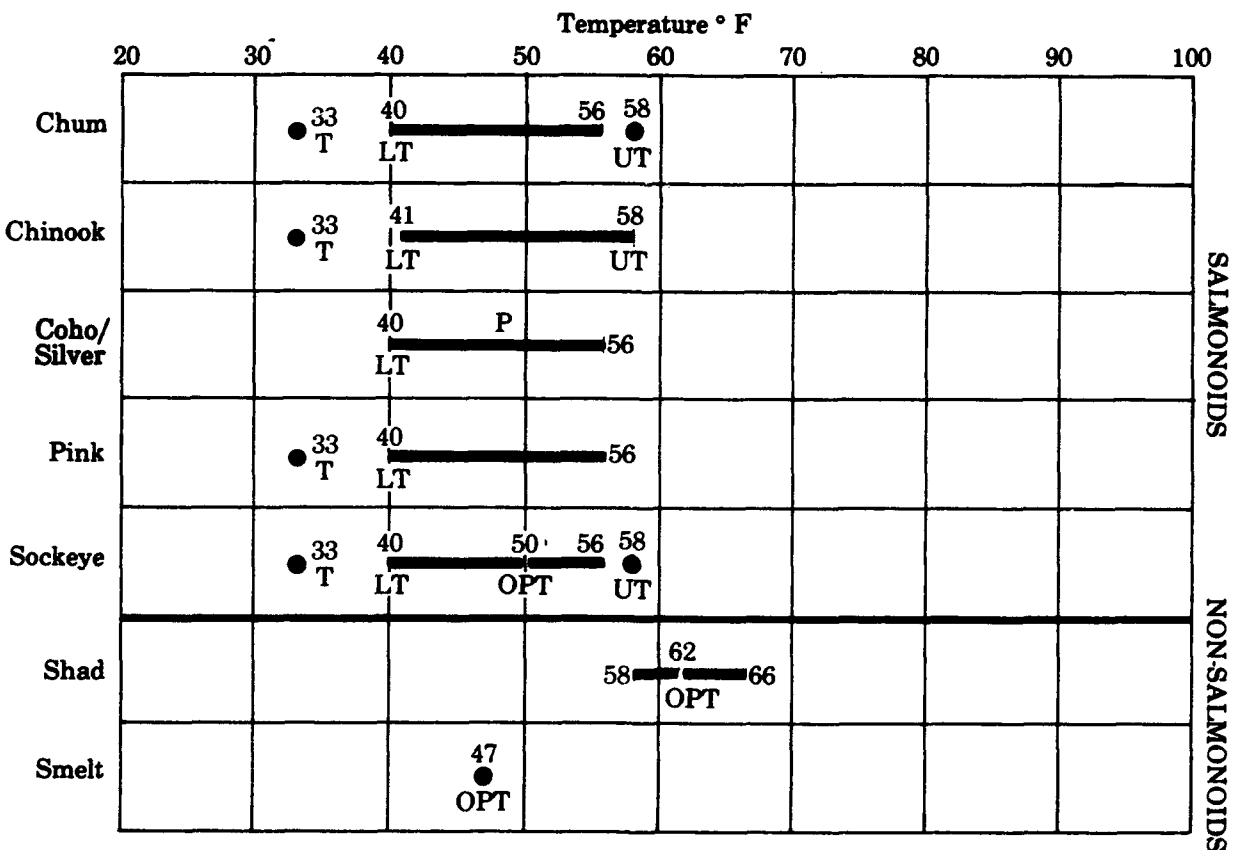

TEMPERATURE - Effects on Fish

E Sportfish - Optimum Range

Temperature ° F

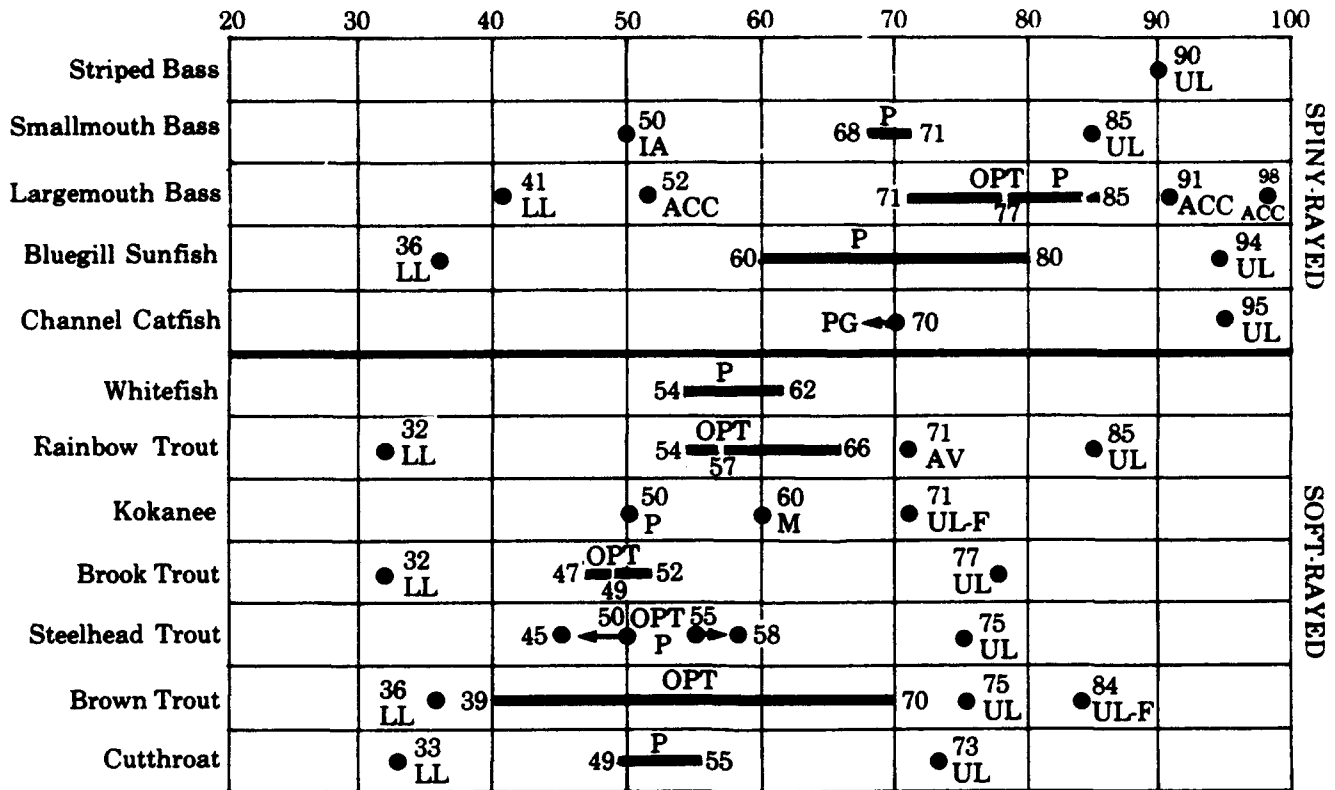

F Sportfish - Spawning Range

Temperature ° F

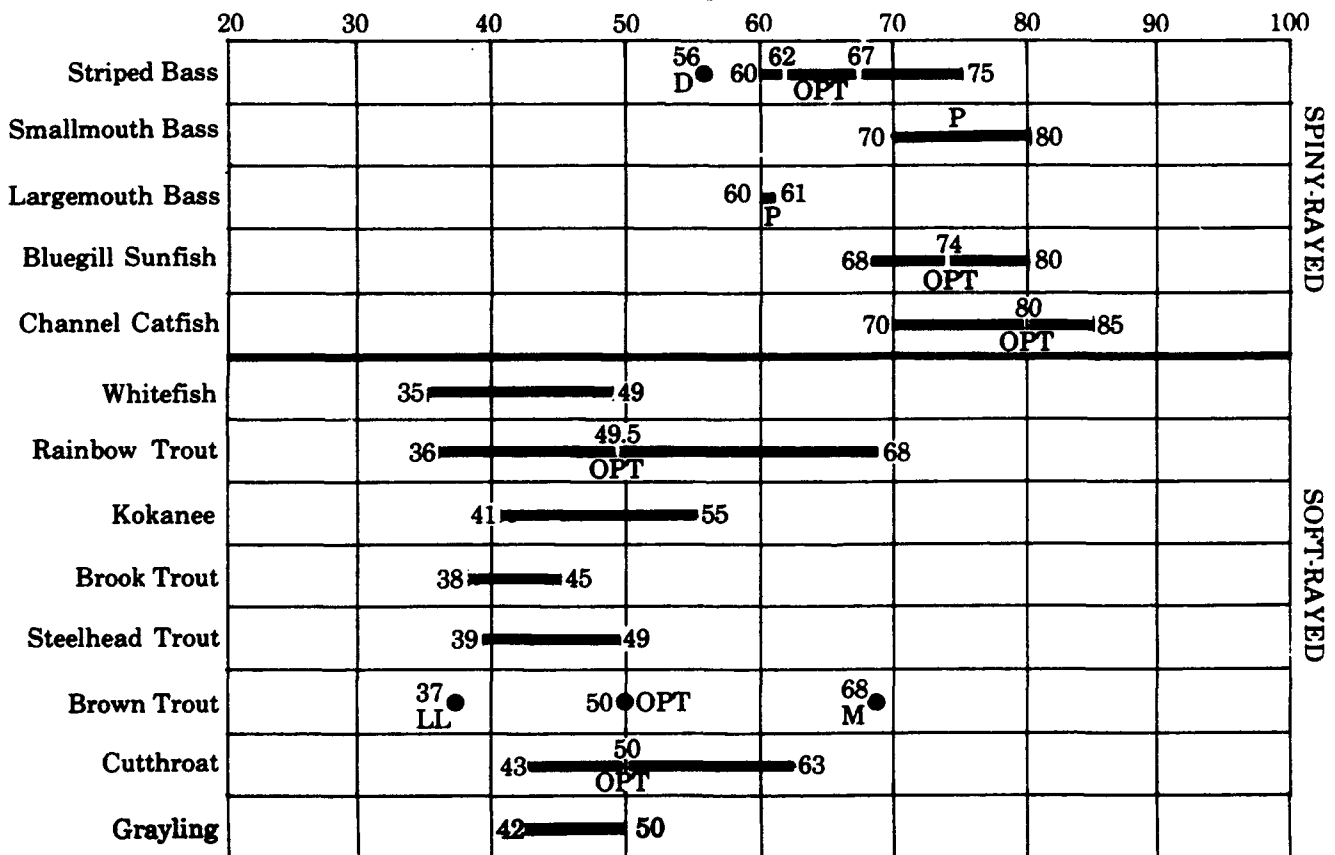

TEMPERATURE - Effects on Fish

G Sportfish - Hatching Range

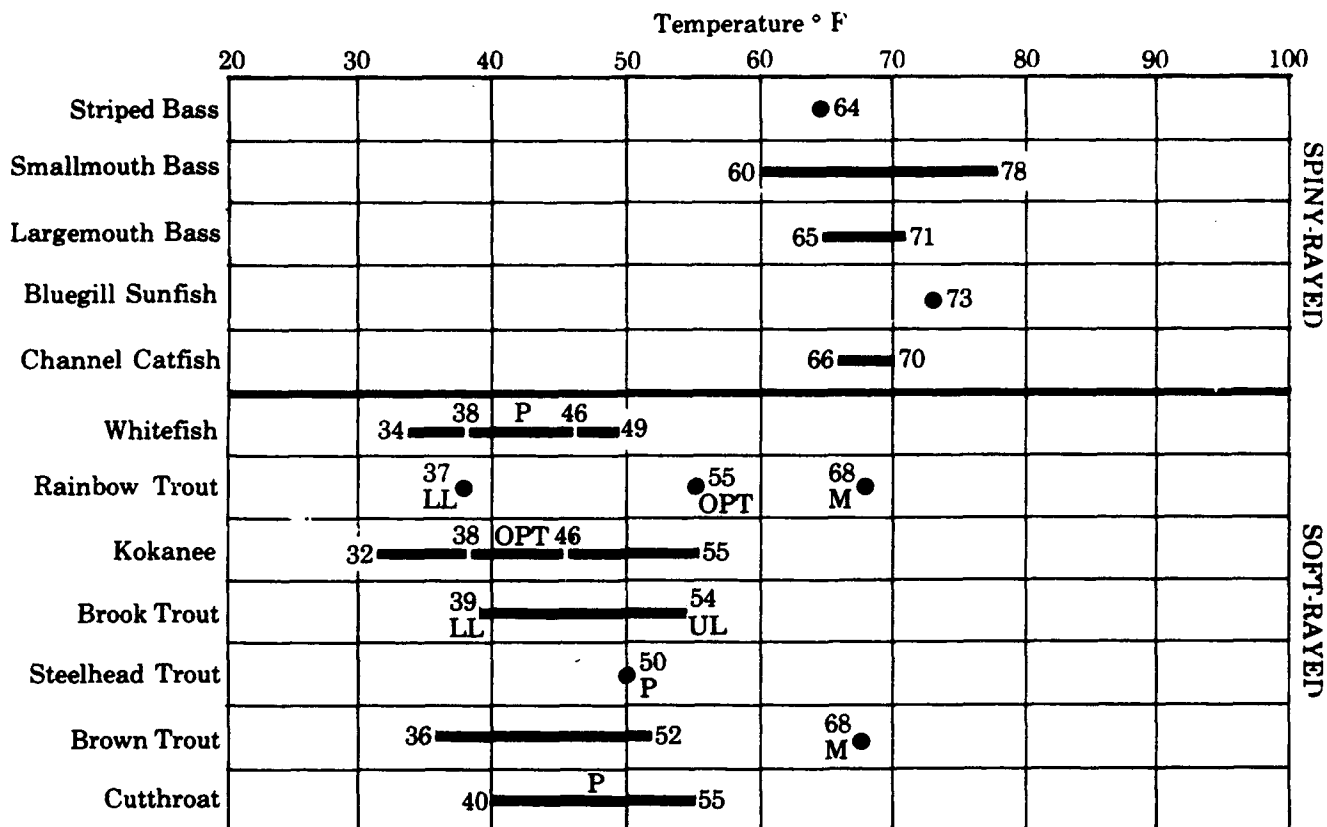

H Miscellaneous Species - Optimum Range

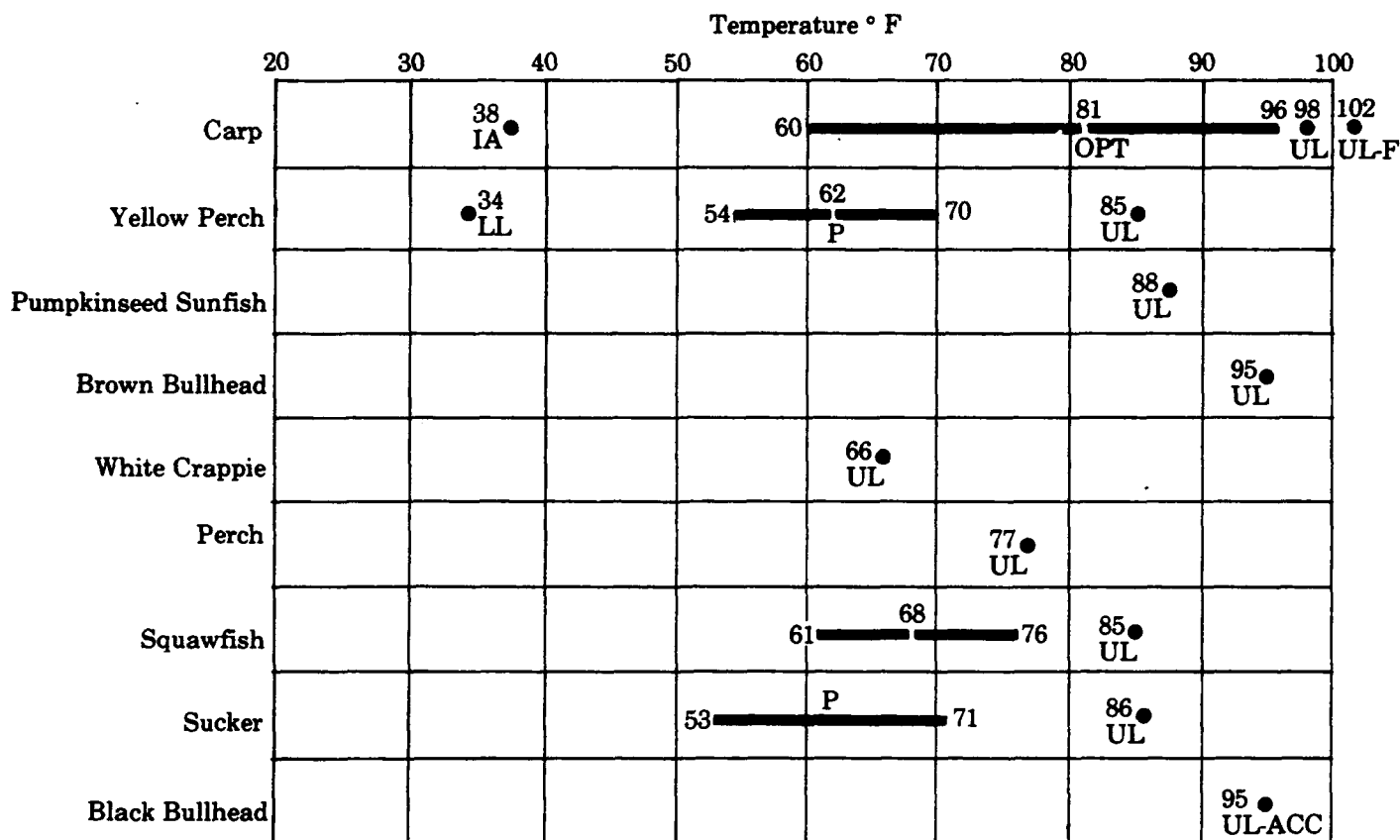

TEMPERATURE - Effects on Fish

**I
Miscellaneous Species - Spawning Range**

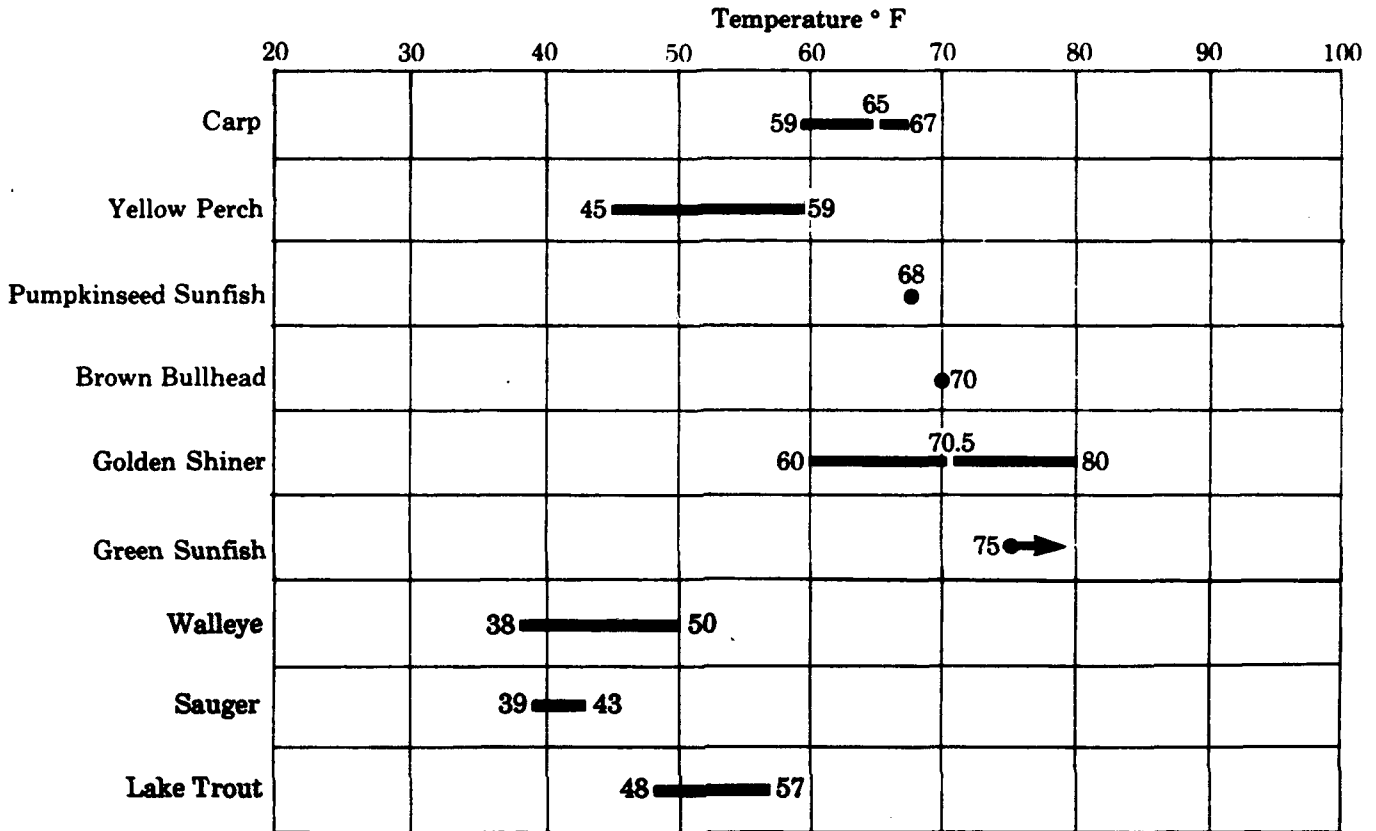

**J
Miscellaneous Species - Hatching Range**

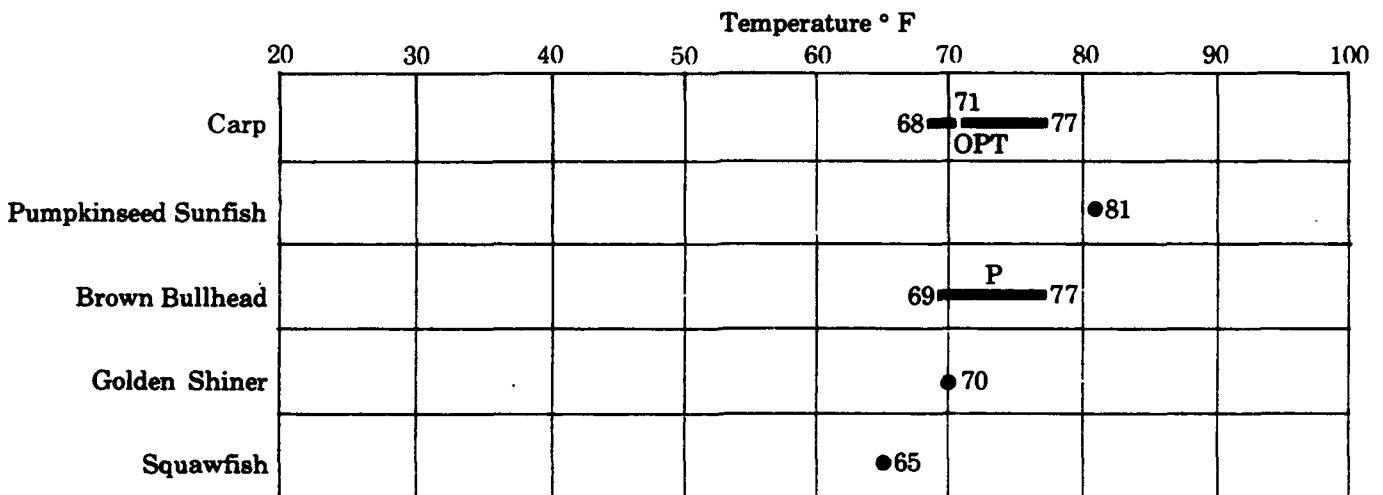

TEMPERATURE - Effects on Fish

**K
Energy Requirements (in k Per Day*)
Compared With Oxygen Demands**

Temperature (° F)	Trout Diet in Ponds		Brett's Oxygen Requirement
	5-6 Inch Fish (0.08 lbs)	10 Inch Fish (0.4 lbs)	8 Inch Fish (0.22 lbs)
41	0.56	1.33	0.3
50	0.91	2.50	0.5
59	1.50	3.32	0.7
68	2.10	5.15	0.9
75	2.90	7.30	1.5

*K = 1000 calories

Prepared by Don M. Fagot from References no. 44 and 46

**L
Digestion Time Required by Trout
at Various Temperatures**

Food Organism (1/2 gram meal)	Hours Required for Complete Digestion at Various Temperatures (° F)			
	49-53	43-44	35-36	32-33
Helodrilus (soft bodied) (oligochaete)	12	18	25	-
Gammarus (intermediate hardness) (amphipod)	13	18	26	43
Archtopsyche (hard bodied) (caddisfly)	16	24	44	70

Adapted from Reference no. 45

**Increase in Metabolic Rate Caused
by Temperature Increase
Fingerlings under Starvation Conditions**

Per Cent Loss Per Day	Average Daily Temperature	
	° C	° F
0.9	7.94	46.3
1.1	11.3	52.3
1.3	14.6	58.3

Adapted from Reference no. 13

**M
Maximum Sustained Cruising Speed of
Sockeye and Coho Underyearlings
In Relation to Temperature**

from Brett, 1958

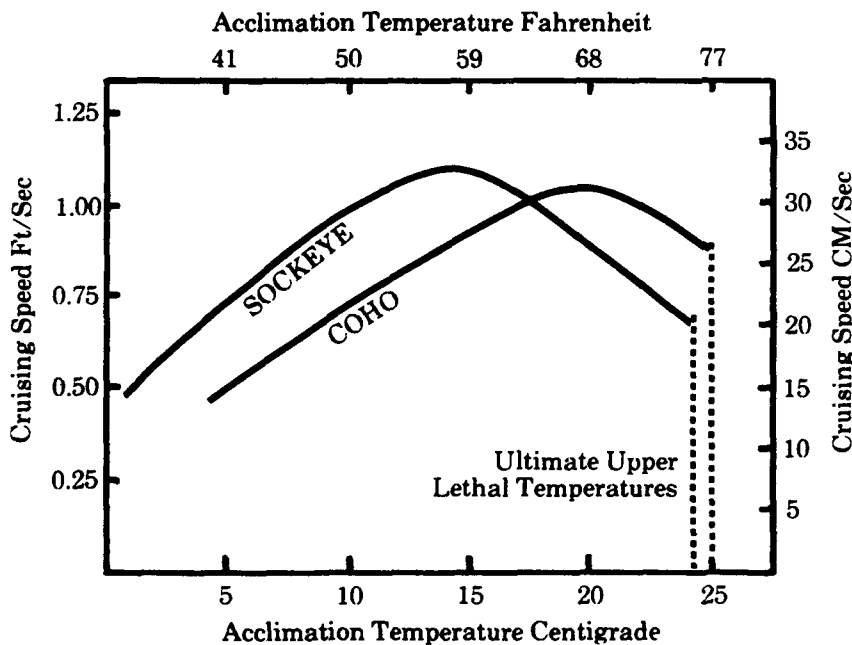

For 1 F. change approximately .026 fps is lost from the maximum point.

The point of maximum efficiency shifts throughout the fish's temperature range, based on adjustment for latitude of residence.

TEMPERATURE - Effects on Fish

References Reviewed

1. Brett, J.R., J.E. Shelbourne, and C.T. Shoop, "Growth rate and body composition of fingerling sockeye salmon, *Oncorhynchus nerka*, in relation to temperature and ration size." Fisheries Research Board of Canada, Journal, 26(9):2363-2394. September, 1969.
2. Burt, Wayne V., "A second forecast of temperature conditions in the Brownlee-Reservoir and in the Snake River below Brownlee Dam." Water Temperature Studies on the Snake River, Technical Report No. 4, Reference 57-5. Unpublished report. Corvallis, Oregon. October, 1957.
3. Seymour, Allyn Henry, "Effects of temperature upon young chinook salmon." Ph.D. thesis. University of Washington, Seattle. 1956.
4. Battelle Memorial Institute, Pacific Northwest Laboratory, "Final report on research related to the development of a power reactor site on the lower Columbia River to Portland General Electric Company, Portland, Oregon." Unpublished. Richland, Washington. June 3, 1968.
5. Spaas, J.T., "Contribution to the comparative physiology and genetics of the European salmonidae. III. Temperature resistance at different ages." Hydrobiologia, 15(1/2):78-88. July, 1960. (Each issue is copyrighted.)
6. Donaldson, Lauren R., and Fred J. Foster, "Experimental study of the effect of various water temperatures on the growth, food utilization, and mortality rates of fingerling sockeye salmon." Transactions of the American Fisheries Society, 70:339-346. September, 1940.
7. Brett, J.R., and D.F. Alderdice, "The resistance of cultured young chum and sockeye salmon to temperatures below 0° C." Fisheries Research Board of Canada, Journal, 15(5):805-813. September, 1958.
8. Combs, Bobby D., "Effect of temperature on the development of salmon eggs." The Progressive Fish-Culturist, 27(3):134-137. July, 1965.
9. Baldwin, N.S., "Food consumption and growth of brook trout at different temperatures." Transactions of the American Fisheries Society, 86:323-328. 1956.
10. Brett, J.R., M. Hollands, and D.F. Alderdice, "The effect of temperature on the cruising speed of young sockeye and coho salmon." Fisheries Research Board of Canada, Journal, 15(4):587-605. July, 1958.
11. Kawajiri, Minoru, "On the relation of growth and death from starvation of the trout fry to temperature." Fisheries Institute of Tokyo, Journal, 24(1):4-8. 1927.
12. Burrows, Roger E., "Water temperature requirements for maximum productivity of salmon." Pacific Northwest Symposium on Water Pollution Research, Proceedings, 12th:29-38. U.S. Department of Health, Education, and Welfare, Public Health Service, Pacific Northwest Water Laboratory, Corvallis, Oregon. November, 1963.
13. Lawrence, W.M., "The effect of temperature on the weight of fasting rainbow trout fingerlings." Transactions of the American Fisheries Society, 70:290-296. 1940.
14. Brett, J.R., "Thermal requirements of fish - three decades of study, 1940-1970." U.S. Robert A. Taft Sanitary Engineering Center, Transactions of the Second Seminar on Biological Problems in Water Pollution held April 20-24, 1959. Technical Report W60-3, pp. 110-117. Cincinnati, Ohio. 1960.
15. Ordal, Erling J., and Robert E. Pacha, "The effects of temperature on disease in fish." Pacific Northwest Symposium on Water Pollution Research, Proceedings, 12th:39-56. U.S. Department of Health, Education, and Welfare, Public Health Service, Pacific Northwest Water Laboratory, Corvallis, Oregon. November, 1963.
16. Brett, J.R., "Temperature tolerance in young Pacific salmon, genus *Oncorhynchus*." Fisheries Research Board of Canada, Journal, 9(6):265-323. November, 1952.
17. Kerr, James E., "Studies of fish preservation at the Contra Costa steam plant of the Pacific Gas and Electric Company." California Department of Fish and Game, Fish Bulletin 92. 1953.
18. Canada Department of Fisheries, "Big Qualicum River biological survey, 1959-60." Vancouver, B.C. January, 1961.
19. Sumner, F.B., and P. Doudoroff, "Some experiments upon temperature acclimatization and respiratory metabolism in fishes." Biological Bulletin, 74(3):403-429. June, 1938. (Each issue copyrighted.)
20. Doudoroff, Peter, "The resistance and acclimatization of marine fishes to temperature changes. 1. Experiments with *girella nigricans* (Ayrea)." Biological Bulletin, 83(2):219-244. October, 1942. (Each issue copyrighted.)
21. Hatheway, Edward S., "The relation of temperature to the quantity of food consumed by fishes." Ecology, 8(4):428-434. October, 1927. (Each issue copyrighted.)
22. Edinger, John E., and John C. Geyer, "Heat-exchange in the environment." (Cooling Water Studies Report No. 2.) Prepared for Edison Electric Institute Research Project No. 49, under Contract PG49.2072 between the Institute of Cooperative Research of the Johns Hopkins University and the Edison Electric Institute. Baltimore, Maryland. June, 1965.
23. Kawajiri, Minoru, "Optimum temperature of water for the hatching of the eggs of trout, *Oncorhynchus masou* (Walbaum)." Fisheries Institute of Tokyo, Journal, 23(2):14-19. 1927.
24. Hildebrand, Samuel F., and William C. Schroeder, "Fishes of Chesapeake Bay." U.S. Bureau of Fisheries, Bulletin, 43, Part I: 1-388. 1928.

TEMPERATURE - Effects on Fish

References Reviewed (Continued)

25. Wurtz, Charles B., and Charles E. Renn, "Water temperatures and aquatic life." Prepared for Edison Electric Institute Research Project No. 49, under Contract PG49.2072 between the Institute of Cooperative Research of the Johns Hopkins University and the Edison Electric Institute. Baltimore, Maryland, June, 1965.
26. Hurley, D.A., and W.L. Woodall, "Responses of young pink salmon to vertical temperature and salinity gradients." International Pacific Salmon Fisheries Commission, Progress Report No. 19. New Westminster, B.C. 1968.
27. Geyer, John C., John E. Edinger, Willard L. Graves, Jr., and Derek K. Brady, "Field sites and survey methods." (Cooling Water Studies Report No. 3.) Prepared for Edison Electric Institute Research Project No. 49, under Contract PG49.2907 between the Institute of Cooperative Research of the Johns Hopkins University and the Edison Electric Institute. Baltimore, Maryland. June, 1968.
28. Mihursky, J.A., and V.S. Kennedy, "Water temperature criteria to protect aquatic life." In American Fisheries Society, Special Publication No. 4:20-32, "A symposium on water quality criteria to protect aquatic life." Supplement to Transactions of the American Fisheries Society, 96(1). January, 1967.
29. Olson, P.A., and R.F. Foster, "Temperature tolerance of eggs and young of Columbia River chinook salmon." Transactions of the American Fisheries Society, 85:203-207. 1955.
30. Jaske, R.T., "Columbia River temperature trends - fact and fallacy." paper presented at Fourth Annual Snake River Editors' Conference in Walla Walla, Washington, May 8, 1969. Unpublished. Battelle Memorial Institute, Pacific Northwest Laboratory, Richland, Washington. May, 1969.
31. "Percentage gain for 28-day period of fall chinook fingerlings of three different sizes reared at four water temperatures." Letter to Milo C. Bell from Roger E. Burrows, Director, Salmon-Cultural Laboratory, U.S. Bureau of Sports Fisheries and Wildlife, Longview, Washington. March, 1969.
32. Moffett, J.W., "The first four years of king salmon maintenance below Shasta Dam, Sacramento River, California." California Fish and Game, 35(2):77-102. April, 1949.
33. U.S. Bureau of Commercial Fisheries, Fish-Passage Research Program, "Temperature standards conducive to optimum production of salmonids in Columbia Basin waterways." Unpublished report for the Columbia Basin Fishery Technical Committee, Seattle, Washington. December, 1966.
34. Altman, Philip L., and Dorothy S. Dittmer, Compiler and Editor, "Environmental biology." Federation of American Societies for Experimental Biology, Bethesda, Maryland. pp. 86-102. 1966. (*All rights reserved. This book protected by copyright.*)
35. Haskell, David C., "Trout growth in hatcheries." New York Fish and Game Journal, 6(2):204-237. July, 1959.
36. Brett, J.R., "Some principles in the thermal requirements of fishes." Quarterly Review of Biology, 31(2):75-87. June, 1956.
37. Adams, J.R., "A review: thermal discharges in the freshwater ecosystem." Unpublished report No. 6934.2-68 submitted to Pacific Gas and Electric Company, Department of Engineering Research, Emeryville, California. 1968.
38. Washington Department of Fisheries, "Research relating to study of spawning grounds in natural areas. Part II. Experimental studies on the survival of the early stages of chinook salmon after varying exposures to upper lethal temperatures." Annual report (June 22, 1953-June 22, 1954), submitted to U.S. Army Corps of Engineers, North Pacific Division, Contract No. DA 350261-Eng-20572. Portland, Oregon, 1954.
39. Brett, J.R., "Some lethal temperature relations of Algonquin Park fishes." University of Toronto Studies, Biological Series 52. (Publications of the Ontario Fisheries Research Laboratory, 63.) University of Toronto Press, Toronto. 1944.
40. Adams, James R., "Thermal power, aquatic life, and kilowatts on the Pacific Coast." Presented at American Power Conference Annual Meeting, Chicago, Illinois, April 22-25, 1969. Unpublished. Pacific Gas and Electric Company, Department of Engineering Research, Emeryville, California. pp. 2-12. 1969.
41. Hata, K., "The influence on environmental changes on fresh water fishes: studies on the influence of rise of water temperature to young trout." Japanese Society of Scientific Fisheries, Bulletin, 15(11):665-670. 1950.
42. Adams, J.R., "Thermal effects and other considerations at steam electric plants: a survey of studies in the marine environment." Unpublished report No. 6934.4-68 submitted to Pacific Gas and Electric Company, Department of Engineering Research, Emeryville, California. August, 20, 1968.
43. Coutant, C.C., "Information on responses to elevated temperature of fishes near Prescott, Oregon important to the commercial or sport fishery of the Columbia River." Supporting final observations to Portland General Electric Company, Portland, Oregon. Unpublished. Battelle Memorial Institute, Pacific Northwest Laboratories, Richland, Washington. pp. 16-32. May, 1968.
44. Brett, J.R., "The swimming energetics of salmon." Scientific American, 213(2):80-85. August, 1965.
45. Reimers, Norman, "Some aspects of the relation between stream foods and trout survival." California Department of Fish and Game, 43(1):43-69. January, 1957.

TEMPERATURE - Effects on Fish

References Reviewed (Continued)

46. Deuel, Charles R., and others, "The New York State fish hatchery feeding chart." Fisheries Research Bulletin No. 3, revised edition. New York State Conservation Department, Albany, New York. 1952.
47. Becker, C. Dale, "Columbia River thermal effects study: reactor effluent problems." Water Pollution Control Federation Journal, 45(5):850-869. May, 1973.
48. Brannon, E.L., "Mechanisms controlling migration of sockeye salmon fry." International Pacific Salmon Fisheries Commission, Bulletin XXI. New Westminster, B.C. 1972.
49. Hocutt, Charles H., "Swimming performance of three warm-water fishes exposed to a rapid temperature change." Chesapeake Science, 14(1):11-16. March, 1973.
50. Sylvester, Robert O., "Water quality study of Wenatchee and Middle Columbia rivers before dam construction." U.S. Fish and Wildlife Service, Special Scientific Report-Fisheries, No. 290. Washington, D.C. 1959.
51. MacKenthun, Kenneth M., and Lowell E. Keup, "Assessing temperature effects with biology." American Power Conference, 31:335-343. Illinois Institute of Technology, Chicago. 1969.
52. Leggett, William C., and Richard E. Whitney. "Water temperature and the migrations of American shad." Fishery Bulletin, 70(3):659-670. 1972.

Chapter 12

Silt and Turbidity

Types of sediment.

Turbidity vs. water color.

Methods of measuring turbidity.

Sedimentation rates and characteristics.

Effect of sedimentation on spawning.

Silt and turbidity causes.

Composition of silt and effect on spawning.

Gill irritation caused by turbid water.

Some species suffer more distress than others.

Adverse effects in hatchery operation.

Table A. Suspended sediment concentrations in ppm in rivers of California, Oregon and Washington in the period 1906-1912.

Table B. Suspended sediment concentration in ppm in the Fraser River at Hope. Suspended sediment concentration in ppm in the Columbia River at Pasco.

Table C. Fatal Turbidity Levels for Various Species.

Figure 1. Relation Between Rate of Flow of Water Through a Gravel Bed and the Survival of Sockeye Eggs in the Gravel.

Figure 2. Grading Curves of Seven Experimental Gravels and Survival of Sockeye Eggs in These Gravels at a Uniform Water Velocity of 0.0167 cm/sec.

Figure 3. The Effect of Gravel Size and Uniformity on the Survival of Sockeye Eggs at a Flow of 0.0167 cm/sec.

References Reviewed.

SILT and TURBIDITY

In considering the effects of transported sediments on stream beds and fisheries, it is necessary to distinguish between the types of sediment.

Bed load is material moving on or near the bed. It may consist of materials rolled or slid along the bed in substantially continuous contact with the bed.

Turbidity is caused by fine materials (silt), mainly inorganic, although it also can be caused by organic materials, or a combination of both.

Turbidity should not be confused with water color, which is due to staining action. Pigment extracts from vegetation often occur in solution in acid swamps and bogs, imparting a brown color to waters emanating from them. Dyes and other highly colored substances frequently present in industrial wastes also may stain water. Since pigments in solution, as well as particles in suspension, reduce the amount of light transmitted, the color of water affects turbidimeter readings, making them too high.

Turbidity in lakes and reservoirs commonly is determined as that depth at which a Secchi disc reading is obtainable. There are at least four recognized methods of measuring turbidity. Where the Jackson turbidity meter is used, the assumption has been made that one Jackson Turbidity Unit (JTU) is equal to one ppm on a silica scale. Other methods give readings in parts per million, weight per volume, or NPU (Nephelometric Turbidity Units). As there is no stated relationship between NTU and mg/L, the following has been taken from Reference No. 27.

"A 5 NTU increase in turbidity in clear-water systems may reduce the primary productivity volume of lakes by approximately 75%, reduce stream productivity by 3-13% or more, and be associated with an increase in suspended sediment concentration of approximately 5-25 mgL⁻¹."

Sedimentation is a result of the settling-out or deposition of suspended materials. This occurs mainly in quiet waters, as lakes, reservoirs and stream sections with low velocities. Particles causing bed load or turbidity may be deposited or suspended, depending on the velocity, and become interchangeable. (See Reference No. 24.)

The sedimentation rates follow Stokes' Law and depend upon (1) the density of the fluid (water) through which the particle is falling, (2) the density or relative weight of the particle, that is, the specific gravity of the particle, and (3) the size of the particle. A sedimentation time of one hour usually is used as an index. As the density of water varies with temperature, a correction must be made.

Some reservoirs are so constructed that they can be flushed periodically to remove the accumulated sediment. When such reservoirs are located upstream from the spawning areas of anadromous fish, the resultant heavy load of silt deposited downstream during flushing may interfere with spawning and seriously reduce successful egg incubation.

Silt may occur as a result of natural causes, such as land slides, the washing of glacial flour and normal bank cutting or bed erosion. In addition, silt materials can be deposited from mining activities, gravel washing, land use and forestry practices.

Excess turbidity from organic materials in the process of oxidation may reduce oxygen below safe levels.

Decaying vegetation is usually not a problem in fast-moving, mountain streams or in conifered watersheds. In slow-moving water or in swamp areas bordered by deciduous trees, such organic materials may cause problems. Turbidity may come from industrial or sewage wastes, or it may be caused by living material such as plankton. Usually, such living material must be present at levels greater than 0.1 percent by volume.

Relatively large quantities (500 to 1,000 ppm) of suspended water-borne material can be carried for short periods of time without detriment to fish. The catch of fish is affected above levels of 30 JTU, as visual references are lost. Primary food production is lowered above levels of 25 JTU.

The effect of bed load is not so well defined by ppm or volume. Its presence can kill buried eggs or alevins by denying water interchange and can smother food organisms.

In Reference No. 16, it is indicated that in the Scott River, California, the organisms, which averaged 249 per square foot above the silt-laden tributary, were reduced to 36 organisms below. This is verified by work below placer mines in Alaska where fine materials were deposited on the bed of a stream. It was found in the Stillaquamish River in Washington that 50 to 100 percent of the eggs deposited were lost, owing to the low permeability of the river bed below a natural slide. Work in Bluewater Creek in Montana (see Reference No. 26) indicated that, when the sediment load in the stream was reduced, the trout production was materially increased and the rough fish production reduced. Studies conducted after a natural slide in the Chilcotin River in British Columbia indicated that salmonoid fish will not move in streams where the silt content is above 4,000 ppm. Streams with silt loads averaging between 80 and 400 ppm should not be considered good areas for supporting fresh water fisheries; streams with less than 25 ppm may be expected to support good fresh water fisheries.

The following is a comparison of lake production and turbidity levels:

	Pounds of Fish Per Acre
Clear lakes below 25 ppm	160
Intermediate lakes (25 to 100 ppm)	94
Muddy lakes over 100 ppm	30

Some species of fish will not spawn in excessively turbid water, such as bass and bluegill. Female salmon and trout, in the course of their prespawning activity, will wash the silt away from the gravel in the redd. However, when the deposition of an excess amount of silt occurs throughout the redd after spawning has been completed, there is a resultant interference with the proper percolation of water through the redd, loss of dissolved oxygen, and lack of proper removal of catabolic products. This "smothering" of eggs also promotes the growth of fungus, which may spread from dead eggs throughout the entire redd. The extent of the harmful effects of siltation on the spawning and egg incubation of salmon and trout depends upon the amount and type of material deposited, as well as the time of occurrence. When silt contains clay particles resembling loam, it may

SILT and TURBIDITY

form a hard, compact crust over the stream bed which spawning fish are unable to remove, thus rendering the spawning area unusable. The same condition may occur when organic materials, such as wood pulp fibers, are mixed with silt, forming an impenetrable mat over the spawning rubble. Silt also may contain toxic residues from industrial or agricultural wastes which may be lethal to developing eggs and alevins.

Generally, salmonoid eggs will suffer a mortality of 85 percent when 15 to 20 percent of the voids are filled with sediment. Properly constructed sediment basins, built in connection with road building activities, gravel wash and mining operations, which effectively remove the sediment, are recommended to eliminate this source of silt.

Most experimental work has shown that whereas fish can survive high concentrations of suspended matter for short periods, prolonged exposure to some types of materials in most species results in a thickening of the cells of the respiratory epithelium (so-called clubbed gills) and the eventual fusion of adjacent gill lamellae, definitely interfering with respiration. Fish do not have gill cleaners for removing foreign matter, and must rely on the flow of water through the gill chambers, the production of lubricating mucous and intermittent "coughing." Evidence of gill irritation in trout and salmon fingerlings held in turbid water has been noted frequently by fish culturists, and is considered a common avenue of infection for fungi and pathogenic bacteria.

It is apparent that some species, such as salmon, suffer more physical distress in turbid water than do others. Carp and bullhead catfish are not visibly affected by some types of turbidity, and will thrive in waters rendered quite turbid by decaying vegetation and other organic material.

Fine materials that cause turbidity are detrimental in

hatchery operations, coating the eggs, and thus reducing the necessary oxygen interchange.

The adverse effects of silt settling in redds have been reported on in References 15, 20 and 24.

Figure 1 gives a graphic presentation of survival versus apparent velocity through the gravel redds.

Table A summarizes sediment concentrations in coastal rivers in California, Oregon and Washington. (See Reference No. 24.)

In some ranch and farm ponds of the midwest and southeastern portions of the United States, colloidal suspensions of finely divided clay particles occur almost continuously, and must be precipitated by chemicals in order for sufficient sunlight to penetrate the water. Ground agricultural limestone (calcium carbonate), superphosphate, alum and agricultural gypsum (calcium sulfate) are used for this purpose.

Table B is included to show the difference in suspended materials between the Fraser River at Hope and the Columbia River at Pasco. Both of these rivers are utilized by salmonoid fish for transportation to their spawning grounds. This indicates that, whereas fish may lose visual reference at the levels of suspended sediment shown, their movement is not impeded.

Table C shows the levels of silt concentrations that cause fatalities in various species. This does not mean that such fish would not have died from lack of natural food at much lower concentrations, either because such food is not visible to the fish or is not present.

Figures 2 and 3, taken from Reference No. 24, show further the effects of silt in spawning areas.

Table A
Suspended Sediment Concentrations in ppm
in Rivers of California, Oregon, and Washington
in the Period 1906-1912

State	Jan	Feb	Mar	Apr	May	June	July	Aug	Sept	Oct	Nov	Dec
Coastal Rivers												
California	139	225	160	126	120	85	80	53	38	48	59	46
Oregon	27	16	9	8	10	8	20	5	6	3	12	6
Washington	12	7	19	18	14	12	6	4	7	16	28	13
Interior Rivers												
California	137	107	88	96	51	32	44	56	42	47	51	79
Oregon	94	107	58	113	107	194	81	74	62	33	37	13
Washington	6	24	47	41	26	14	16	17	13	14	19	14

SILT and TURBIDITY

Table B
Suspended Sediment Concentration in ppm
in the Fraser River at Hope

Year	Jan	Feb	Mar	Apr	May	June	July	Aug	Sept	Oct	Nov	Dec
1950	370	503	189	98	.	26	.	28
1951	.	23	.	162	672	187	127	73	45	.	31	.
1952	.	.	15	970	374	200	158	96	57	.	.	.

Suspended sediment concentration in ppm in the Columbia River at Pasco.

Year	Jan	Feb	Mar	Apr	May	June	July	Aug	Sept	Oct	Nov	Dec
1910-1911 Average	4	17	46	15	10	4	2	2	3	2	2	3
1954-1956 Average	.	.	8	19	19	14	8	9	5	13	6	2

Reference No. 24.

Table C
Fatal Turbidity Levels for Various Species

Common Name of Fish	Range of Temperature (degrees C)	Average time of test (days)	Fatal Turbidity in ppm		
			Minimum	Average	Maximum
Golden shiner	20-29	7.1	55,000	166,000	200,000
Mosquito fish	20-28	16.5	120,000	181,500	225,000
Goldfish	24-32	12.0	90,000	197,000	270,000
Green sunfish	20-29	5.5	50,000	166,500	225,000
Black bullhead	22-32	17.0	175,000	222,000	270,000
Red shiner	22-32	9.0	175,000	183,000	190,000
River carpsucker	24-32	9.6	105,000	165,000	250,000
Largemouth bass	16-32	7.6	52,000	101,000	150,000
Pumpkinseed	16-22	13.0	16,500	69,000	120,000
Orangespotted sunfish	22-32	10.0	100,000	157,000	200,000
Channel catfish	24-32	9.3	—	85,000	—
Blackstrip top-minnow	22-26	19.3	—	175,000	—
Black crappie	28-29	2.0	—	145,000	—
Rock bass	—	3.5	—	38,250	—

Reference "Water Quality Criteria," McKee and Wolf, 1963.

SILT and TURBIDITY

Figure 1
Relation Between Rate of Flow of Water
Through a Gravel Bed and the Survival of
Sockeye Eggs in the Gravel

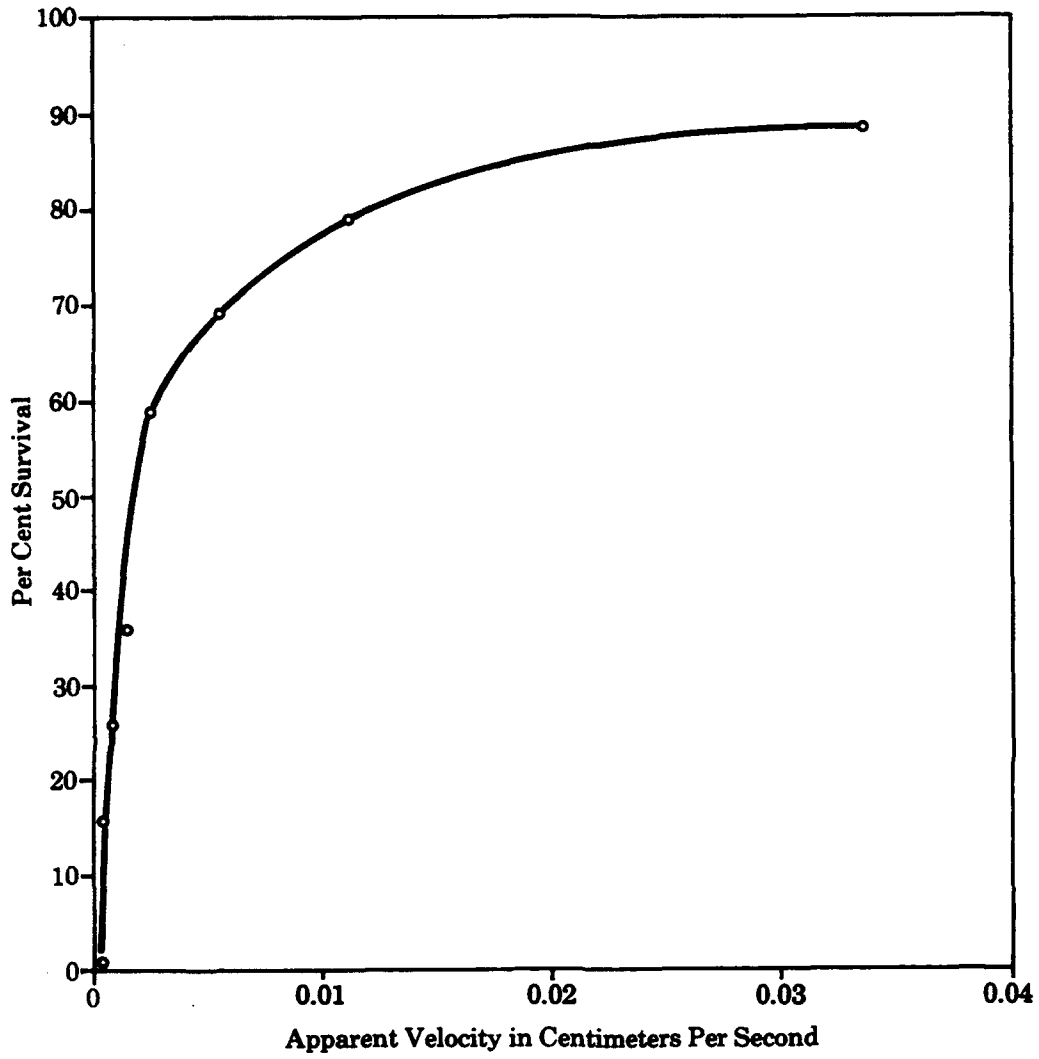

See Reference No. 24

SILT and TURBIDITY

Figure 2
Grading Curves of Seven Experimental Gravels
and Survival of Sockeye Eggs in These Gravels at a
Uniform Water Velocity of 0.0167 cm/sec

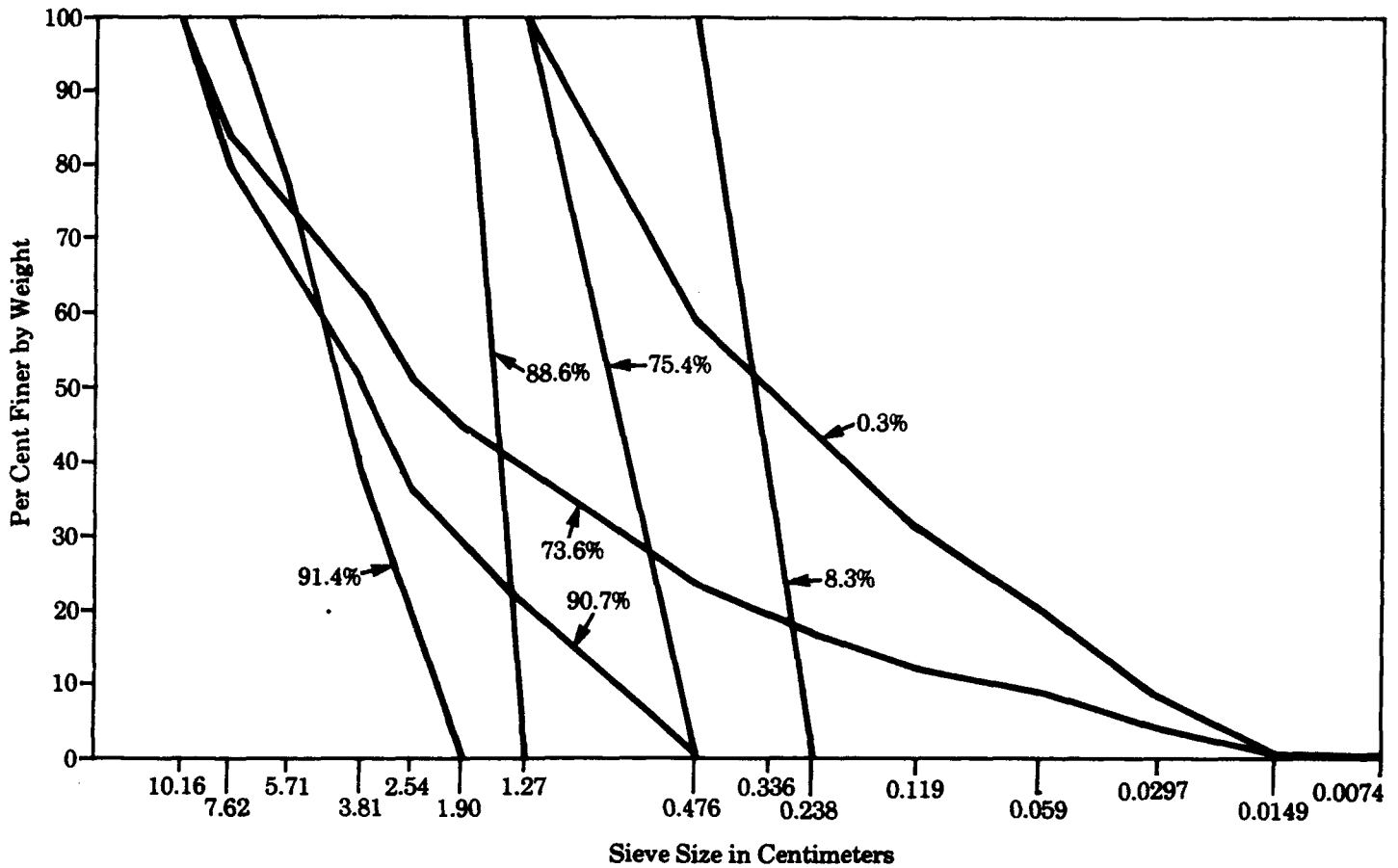

See Reference No. 24.

SILT and TURBIDITY

Figure 3
The Effect of Gravel Size and Uniformity on
the Survival of Sockeye Eggs at a Flow of 0.0167 cm/sec

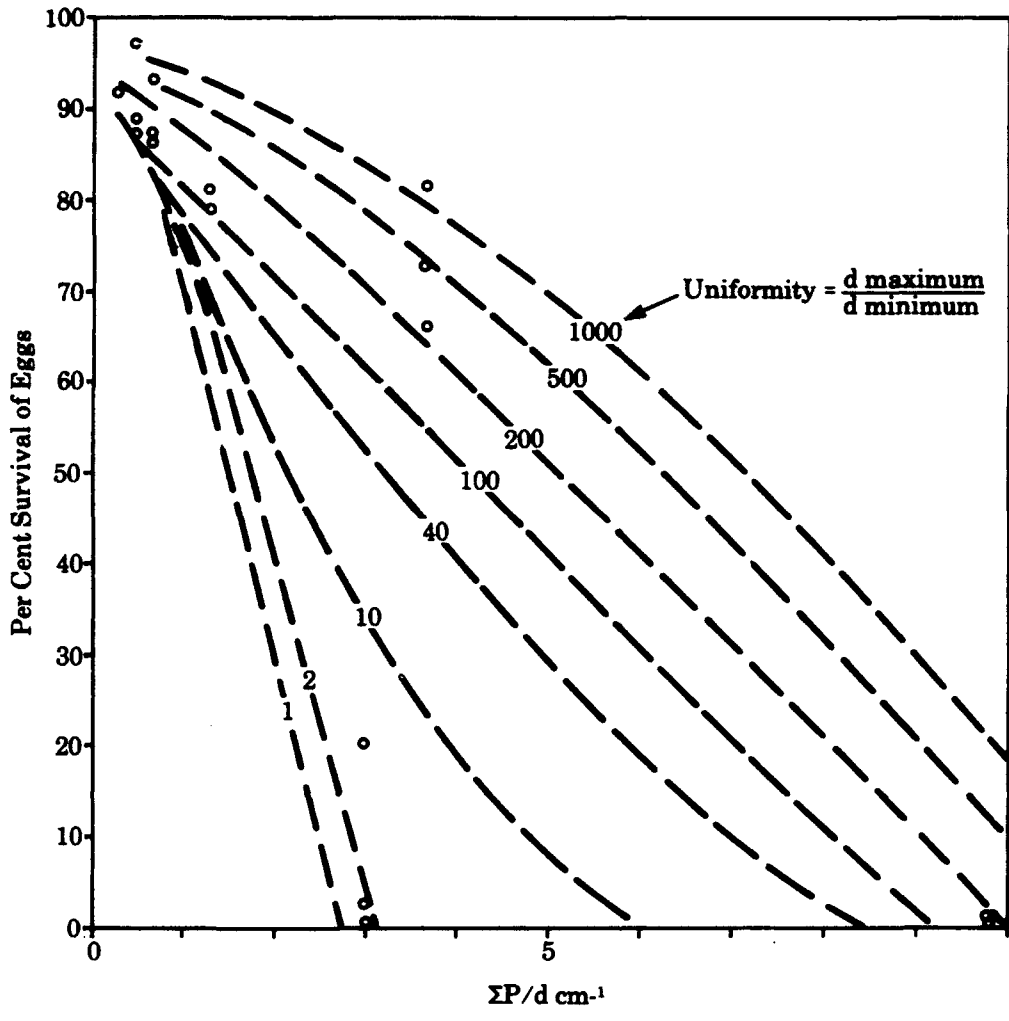

See Reference No. 24.

SILT and TURBIDITY

References Reviewed

1. MacKinnon, D., L. Edgeworth, and R.E. McLaren, "An assessment of Jones Creek spawning channel 1954-1961." *The Canadian Fish Culturist*, Issue 30:3-14. December, 1961.
2. Fields, Paul E., "Migrant salmon light guiding studies at Columbia River dams." Final report submitted to the U.S. Army Corps of Engineers, North Pacific Division, Fisheries Engineering Research Program, pp. 1-266. Contract No. DA-45-108-Civeng-63-29. Portland, Oregon. February, 1966.
3. Eschner, Arthur R., and Jack Larmoyeux, "Logging and trout: four experimental forest practices and their effect on water quality." *The Progressive Fish-Culturist*, 25(2):59-67. April, 1963.
4. Merrell, Theodore R., and Melvin D. Collins, "An investigation of adult chinook salmon mortality in the vicinity of Bonneville Dam, 1954 and 1955, on the Columbia River." Unpublished final report for Oregon Fish Commission under Contract No. DA-35-026-eng-20892. Portland, Oregon. August, 1960.
5. McIrvin, Ronald David, "Fine particle movement through a granular bed." M.S. thesis. University of Washington, Seattle, Washington. 1965.
6. Heg, Robert T., "Stillaguamish slide study: summary of data obtained by Research Division during 1952." Unpublished report. Washington Department of Fisheries, Olympia, Washington. 1952.
7. McNeil, William J., "Environmental factors affecting survival of young salmon in spawning beds and their possible relation to logging." U.S. Fish and Wildlife Service, Bureau of Commercial Fisheries, Manuscript Report No. 64-1. Washington, D.C. April, 1964.
8. Washington Department of Fisheries, "Propagation of fall chinook salmon in McNary Dam experimental spawning channel." Summary report (1957 through 1963) submitted by John S. Chambers to the U.S. Army Corps of Engineers, Contract No. DA-45-164-Civeng-5-4.
9. Washington Department of Fisheries, "Research relating to McNary supplemental spawning channel." Annual report (July 1, 1963 through June 10, 1964) submitted by John S. Chambers to U.S. Army Corps of Engineers, Contract No. DA-35-026-Civeng-58-23. 1964.
10. Wickett, W.P., "Effects of siltation on success of fish spawning." Pacific Northwest Symposium on Water Pollution Research, Proceedings, 5th:16-22. U.S. Public Health Service, Water Supply and Water Pollution Control Program, Portland, Oregon. March 23-24, 1959.
11. McNeil, William J., and Warren H. Ahnell, "Success of pink salmon spawning relative to size of spawning bed materials" U.S. Fish and Wildlife Service, Special Scientific Report, Fisheries No. 469. Washington, D.C. January, 1964.
12. Shannon and Wilson, Engineers, "Report on slide on South Fork Stillaguamish River at Gold Basin Forest Camp." Unpublished report to the Washington Department of Fisheries, Olympia, Washington. September 30, 1954.
13. Shannon, William D., and Associates, "Report on slide on North Fork Stillaguamish River near Hazel, Washington." Unpublished report prepared for Washington Department of Game and Department of Fisheries. Seattle, Washington. February 20, 1952.
14. Kuenen, P.H., and F.L. Humbert, "Bibliography of turbidity currents and turbidities." In "Turbidities" ("Developments in sedimentology," Volume 3), edited by A.H. Bouma and A. Brouwer.
15. Shapovalov, Leo, and William Berrian, "An experiment in hatching silver salmon eggs in gravel." *Transactions of the American Fisheries Society*, 69:135-139. 1939.
16. Smith, Osgood R., "Placer mining silt and its relation to salmon and trout on the Pacific Coast." *Transactions of the American Fisheries Society*, 69:225-230. 1939.
17. Hobbs, Derisley, "Natural reproduction of quinnat salmon, brown and rainbow trout." *New Zealand-Marine Department, Fisheries Bulletin No. 6*. 1937.
18. U.S. Federal Water Control Administration, Northwest Region, Alaska Water Laboratory, "Effects of placer mining on water quality in Alaska." College, Alaska. February, 1969.
19. Tebo, L.B., "Effects of siltation, resulting from improper logging, on the bottom fauna of a small trout stream in the Southern Appalachians." *The Progressive Fish-Culturist*, 17(2):64-70. April, 1955.
20. Shelton, J.M., and R.D. Pollock, "Siltation and egg survival in incubation channels." *Transactions of the American Fisheries Society*, 95(2):183-187. April, 1966.
21. Pautzke, Clarence F., "Studies on the effect of coal washings on steelhead and cutthroat trout." *Transactions of the American Fisheries Society*, 67:232-233. 1937.
22. American Public Health Association, American Water Works Association and Water Pollution Control Federation, "Standard methods for the examination of water and wastewater, including bottom sediments and sludges." American Public Health Association, New York, New York. 12th edition. 1965.
23. Colby, B.R., and D.W. Hubbell, "Simplified methods for computing total sediment discharge with the modified Einstein procedure." U.S. Geological Survey, Water Supply Paper 1593. Washington, D.C. 1961.

SILT and TURBIDITY

References Reviewed (Continued)

24. Cooper, A.C., "The effect of transported stream sediments on the survival of sockeye and pink salmon eggs and alevin." International Pacific Salmon Fisheries Commission, Bulletin XVIII. New Westminster, B.C. 1965.
25. Marcuson, Pat, "Stream sediment investigation." Montana Fish and Game Department, Fisheries Division, South Central Montana Fishery Study. Job Completion Report, Research Project Segment. Project No. F-20-R-13, Job No. III. Helena, Montana. Unpublished. October 1, 1967 through September 30, 1968.
26. Peters, John C., "The effects of stream sedimentation of trout embryo survival." Montana Fish and Game Department, Billings, Montana. 1962.
27. Environment Canada. "Canadian water quality guidelines." Prepared by the Task Force on Water Quality Guidelines. Ottawa, Ontario. March, 1987.

Chapter 13

Toxicities of Elements and Compounds

Limits (goals and standards) in fresh and salt water for the following elements and compounds are given. Effects on fish life are reported.

Aluminum

Ammonia nitrogen

Arsenic

Barium

Boron

Cadmium

Chromium

Copper

Cyanide

Fluoride

Hydrogen sulfide (H₂S)

Iron

Lead

Manganese

Mercury

Methanethiol

Methyl ethyl Ketone

Nitrate

Nitrogen

Phenol and Phenolic Compounds

Phosphates

Potassium

Radioactivity

Selenium

Silver

Sodium

Surfactants

Zinc

Miscellaneous

References Reviewed.

TOXICITIES OF ELEMENTS AND COMPOUNDS

The goals and standards (Ref. 2) in these tables were initially set by the authors from data examined prior to 1967. Changes, if any, from the initial goals and standards were obtained from the additional credited references (4, 5 and 6) which set upper limits and are reflected in the tables.

Remarks	Limits Water Quality Criteria		Effects on Fish
Aluminum			
Aluminum is more toxic to fish in acid water than in neutral water. Higher concentrations may be toxic to food organisms.	Ref. 5	0.01 mg/1	Aluminum is extremely toxic to small fish in the early development of salmonids (sac fry level).
	Ref. 6	0.005 mg/1 (at pH < 6.5) 0.1 mg/1 (at pH > 6.5)	
Ammonia nitrogen			
The U.S.P.H.S. Drinking Water Standards lists no limit for ammonia nitrogen, although the WHO European Drinking Water Standards set a recommended limit of 0.5 mg/1 as NH ₄ . However, any such limits are based on the presence of ammonia being an indicator of organic pollution rather than on its toxicity.	Ref. 2	Fresh Water	Fish appear to be more affected by undissociated ammonium hydroxide (NH ₄ OH) than by the ammonium ion (NH ₄ ⁺). Thus the toxicity of a given concentration of ammonia to fish increases with increasing pH. As with most other toxicants, the effects of ammonia are increased at low oxygen concentrations. The concentrations of ammonia at which fish suffer distress are variously reported at from 0.3 mg/1 upward, but the majority of values indicated lie above 1.0 mg/1.
	Goal*	0.3 mg/1	
Standard**	0.5 mg/1		
	Salt Water		
Goal	0.0025 mg/1		
Standard	0.003 mg/1		
Ref. 4	0.02 ppm		
Ref. 5	0.0125 mg/1		
Ref. 6	Soft Water Hard Water		
	2.2 mg/1 1.37 mg/1		
Because of its potentially toxic effects on fish and because of the fact that it indicates organic pollution of water and serves as a nutrient for nuisance growth, the following limits are proposed for ammonia nitrogen.			
Arsenic			
Arsenic compounds occur naturally in some waters of the Western United States. The elemental arsenic is reported to be insoluble in water, but many of the arsenates are highly soluble. It is found as a by-product from the processing of ores and may be liberated as dust. It is used in other metallurgical processes in the manufacture of glassware and ceramics. It is used in tanneries and dye manufacture and other chemical industries.	Ref. 2	Fresh Water	Certain species of fish are killed at levels above 0.01 mg/1 after exposure of 48 hrs. It is less toxic to mayflies, nymphs and bacteria.
	Goal	0.01 mg/1	
	Standard	0.05 mg/1	
	Ref. 5	0.05 mg/1	
	Ref. 6	0.05 mg/1	
Barium			
Appears to be less cumulative in the body than some other metallic poisons. Indications are that in the carbonate or sulfate form it is relatively insoluble and therefore not apt to be present in solution. In Washington most streams contain sufficient bicarbonate to precipitate all but minute amounts of barium. Could be present in colloidal suspension, a chelate, an organic compound, or in other ways.	Ref. 2	Fresh Water	WQC suggests a limit of 5.0 mg/1 is to protect fish and aquatic life from toxic effects.
	Goal	0.01 mg/1	
	Standard	0.05 mg/1	
		Salt Water	
	Goal	0.05 mg/1	
Standard	0.06 mg/1		
	Ref. 5	5.0 mg/1	

* Goal, the more restrictive of the quality criteria, is defined as the desirable value of water quality parameters, which may or may not be practicable at the present time.

** Standard, the less restrictive of the quality criteria, is proposed as an objective to be achieved or maintained immediately or within a short period of time.

TOXICITIES OF ELEMENTS AND COMPOUNDS

Remarks	Limits Water Quality Criteria		Effects on Fish	
Boron				
Although boron may be toxic to humans and animals in high concentrations. there appears to be so little likelihood of such concentrations being reached that boron is not considered a hazard. Boron is believed to be present in Washington waters in only trace amounts.	Ref. 2	Fresh Water		
	Goal		0.1 mg/1	
	Standard		0.3 mg/1	
		Salt Water		
	Goal		4.7 mg/1	
	Standard		5.5 mg/1	
Cadmium				
The Dept. of Health, Education and Welfare, Public Health Service, Drinking Water Standards, imposes a mandatory limit on cadmium of 0.01 mg/1, on the basis of its toxicity to humans. Cadmium appears to be somewhat cumulative in the body.	Ref. 2	Fresh Water		
	Goal		0.0005 mg/1	
	Standard		0.001 mg/1	
		Salt Water		
	Goal		0.00011 mg/1	
	Standard		0.00013 mg/1	
	Ref. 4	Soft Water Hard Water	0.004 ppm 0.003 ppm	Fish appear to be quite sensitive to cadmium. In addition there appears to be a synergistic effect between cadmium and other metals, notably zinc. The lowest concentration indicated as being lethal to fish is equal to the U.S.P.H.S. limit of 0.01 mg/1. Salmon fry are reported to have been killed by 0.03 mg/1 of cadmium together with 0.15 mg/1 of zinc.
	Ref. 5	Soft Water Hard Water	0.0005 mg/1 0.005 mg/1	
	Ref. 6	Soft Water	0.8 µg/1	
	Chromium			
Chromium does not appear to be cumulative in the body. The U.S.P.H.S. limit is derived partially from the fact that 0.05 mg/1 is about the lower limit of detectability of hexavalent chromium. Published information indicates that much larger concentrations are without adverse effects upon humans, and it is probable that the U.S.P.H.S. limit of 0.05 mg/1 is extremely conservative. Chromium appears toxic to plants, but the level at which toxic effects begin to be discernible appears to be not less than 1.0 mg/1.	Ref. 2	Fresh Water		
	Goal		Trace	
	Standard		0.01 mg/1	
		Salt Water		
	Goal		0.00005 mg/1	
	Standard		0.00006 mg/1	
	Ref. 4		0.03 ppm	
	Ref. 5		0.03 mg/1	
	Ref. 6	(fish) (aquatic life)	0.02 mg/1 2.0 µg/1	

TOXICITIES OF ELEMENTS AND COMPOUNDS

Remarks	Limits Water Quality Criteria		Effects on Fish	
Copper				
<p>The U.S.P.H.S. Drinking Water Standards recommended limit on copper is 1.0 mg/1.</p> <p>Copper is essential to plant life, but toxic when present in excess. The permissible range appears to lie below about 0.1 mg/1 for the most sensitive macroscopic plants.</p> <p>Threshold toxic limits of copper to animals appear to be substantially higher than the limit proposed for human use.</p> <p>Copper sulfate is widely used as a cheap and effective algicide; however, in hard water the margin between the dosage required as an effective algicide and the toxic level for fish is very narrow, and may result in fish kills.</p> <p>Marine biota are sensitive to copper. Oyster larvae require some copper (0.05-0.06 mg/1), but toxic effects begin to occur between 0.1 and 0.5 mg/1.</p>	Ref. 2	Fresh Water	<p>The effects of copper on fish appear to be magnified enormously by its synergistic association with zinc, cadmium, phosphate, chloride, mercury and other materials. Concentrations of copper as low as 0.015 mg/1 have been reported as toxic. The effect of copper is pronounced in soft water, possibly because copper carbonate precipitates from hard water and thus limits the concentration of copper in solution. Other aquatic organisms of importance to the food chain of fish are quite sensitive to copper. The maximum concentration of copper sulfate for trout is 0.014; carp 0.30, and gold fish 0.50.</p>	
	Goal			0.02 mg/1
	Standard			0.05 mg/1 above natural background
		Salt Water		
	Goal			<0.05 mg/1
	Standard			<0.06 mg/1
	Ref. 4	Soft Water	0.006 ppm	
		Hard Water	0.03 ppm	
	Ref. 5.	Soft Water	0.006 mg/1	
		Hard Water	0.03 mg/1	
	Ref. 6	Soft Water	2 ug/1	
		Hard Water	3 ug/1	
Cyanide				
<p>The U.S.P.H.S. Drinking Water Standards contain both recommended (0.01 mg/1) and the mandatory (0.2 mg/1) limits for cyanide. These limits are based on toxicity, but the derivation of them appears to be founded more on toxicity to fish than to humans.</p> <p>Stock and wildlife appear no more sensitive toward cyanide than do humans.</p>	Ref. 2	Fresh Water	<p>Fish appear quite sensitive to cyanide, more so than do lower forms of aquatic life. The lowest concentration at which toxic effects are noted is 0.05 mg/1 (trout); but 0.02 mg/1 were survived by trout for a period of 27 days. In view of the other data cited, the U.S.P.H.S. recommended limit (0.01 mg/1) is probably a reasonable limit for safety to all aquatic life.</p>	
	Goal			0.005 mg/1
	Standard			0.01 mg/1
		Salt Water		
	Goal		None detectable	
	Standard		0.01 mg/1	
	Ref. 6		5.0 ug/1	
Fluoride				
<p>The U.S.P.H.S. Drinking Water Standards mandatory fluoride limit varies from 0.6 to 1.7 mg/1, depending in part on the average air temperature and hence the amount of water consumed per day. For drinking purposes, fluoride is generally considered to be a valuable addition to water. Too much fluoride, however, leads to mottled tooth enamel and in high doses it can be toxic.</p> <p>The threshold concentration of fluoride in water at which damage to irrigated crops begins to occur appears to lie between 10 and 100 mg/1.</p> <p>1.0 mg/1 of fluoride seems to have no deleterious effect on livestock.</p>	Ref. 2	Fresh Water	<p>Fish and other aquatic life appear to be affected by fluoride in much the same way as do land animals, and in approximately the same concentration ranges. The lowest concentration at which adverse effects are reported (slower and poorer hatchings)(species not identified) is 1.5 mg/1.</p>	
	Goal			0.5 mg/1
		Salt Water		
	Goal			1.3 mg/1
	Standard		1.5 mg/1	
	Ref. 5		0.5 mg/1	

TOXICITIES OF ELEMENTS AND COMPOUNDS

Remarks	Limits	Water Quality Criteria	Effects on Fish
Hydrogen sulfide (H₂S)			
<p>The sources of H₂S in water include natural processes of decomposition, sewage and industrial wastes, such as those from tanneries, paper mills, textile mills, chemical plants, and gas-manufacturing works. It is a major component of Kraft mill waste liquors, which is the principal source of this type of pollution in the Pacific Northwest.</p> <p>In the presence of certain sulfur-utilizing bacteria, sulfides and H₂S can be oxidized to colloidal sulfur, and these bacteria or their deposits may be considered as corollary pollutants.</p>	Ref. 2		<p>H₂S at a concentration of 10 mg/1 has been reported as toxic to a salmon and trout in 24 hours.</p> <p>At a concentration of 10.0 mg/1 it is reported as toxic to trout in 15 minutes.</p>
	<p>The maximum concentration of H₂S tolerated by fish is within the range of 0.3-1.0 mg/1. Chinook salmon have survived in tests at a H₂S concentration of 0.3 mg/1, cutthroat trout at 0.5 mg/1, and silver salmon at 0.7 mg/1.</p>		
	Ref. 4	0.002 ppm	
	Ref. 5	0.003 mg/1	
Iron			
<p>Stock and wildlife require some iron as do humans. There is no evidence to indicate that the toxicity threshold for animals is substantially lower than for humans.</p> <p>Irrigated agriculture is relatively unaffected by iron. Some iron appears to be beneficial to certain plants.</p>	Ref. 2	Fresh Water	<p>Fish may be adversely affected by dissolved iron, although the amount of iron in solution (ferrous iron) will be extremely small in well-aerated streams, i.e., those capable of supporting fish. There is some evidence that concentrations as low as 0.2 mg/1 of ferrous iron may be deleterious, but some fish are known to thrive at higher concentrations.</p>
	Goal	0.0 mg/1	
	Standard	0.1 mg/1	
	(Total iron above natural content.)		
		Salt Water	
	Goal	0.1 mg/1	
	Standard	0.2 mg/1	
	Ref. 4	0.5 ppm	
	Ref. 5	0.1 mg/1	
	Ref. 6	0.3 mg/1	
Lead			
<p>The U.S.P.H.S. Drinking Water Standards mandatory limit on lead concentration is 0.05 mg/1. This limit is based on the toxicity of lead, enhanced by its tendency to accumulate in the body.</p> <p>There is some evidence that lead is injurious to plants, but the threshold concentrations appear to be well above the U.S.P.H.S. Drinking Water Standards limit.</p> <p>Animals are sensitive to lead poisoning, as are humans, and apparently to about the same extent.</p> <p>Aquatic life also is susceptible to toxic effects from lead, although the mechanism by which the damage occurs may be different.</p>	Ref. 2	Fresh Water	<p>As in the case of certain other toxics, lead appears more toxic to fish life in soft than in hard water. Reduction of the oxygen saturation percentage appears to accentuate the effect of lead somewhat. Toxic effects from lead have been reported in fish at concentrations as low as 0.01 mg/1, although other tests have shown absence of toxic effects at concentrations as high as 4.0 mg/1.</p>
	Goal	Limit of detectability	
	Standard	0.02 mg/1	
		Salt Water	
	Goal	0.00003 mg/1	
	Standard	0.004 mg/1	
	Ref. 4	0.03 ppm	
	Ref. 5	0.02 mg/1	
	Ref. 6	Soft Water 2 µg/1	
		Hard Water 4 µg/1	

TOXICITIES OF ELEMENTS AND COMPOUNDS

Remarks	Limits Water Quality Criteria		Effects on Fish		
Manganese					
<p>The U.S.P.H.S. Drinking Water Standards recommended limit on manganese of 0.05 mg/1 is based on esthetic and economic as well as physiological considerations. The physiological hazards from excessive manganese are of dubious nature and occur at uncertain threshold concentration values, but it is apparent that 0.05 mg/1 is substantially below any toxicity threshold.</p> <p>Excessive concentrations of manganese may be harmful to plants, but the threshold levels of damage appear substantially higher than the Drinking Water Standards limit.</p> <p>Animals appear to be unaffected by manganese at concentrations substantially higher than the U.S.P.H.S. limit.</p>	Ref. 2	Fresh Water	<p>Fish appear to have some tolerance for manganese and at the limit of 0.05 mg/1 it probably is not detrimental to them.</p>		
	Goal Standard	Trace 0.01 mg/1 total Mn			
	Goal Standard	Salt Water 0.002 mg/1 0.04 mg/1			
	Ref. 5	0.01 mg/1			
Mercury					
<p>Mercury has been found to be inert, but enters the aquatic food chain and becomes concentrated in fish and is transferred from prey to predator.</p>	Ref. 2	Fresh Water	<p>At this time mercury kills have not been reported.</p>		
	Goal Standard (interim)	Limit of detectability 0.05 mg/1			
	Ref. 4	0.05 (ppb average)			
	Ref. 5	0.0002 mg/1			
	Ref. 6	0.1 µg/1			
Methanethiol					
<p>This gas is also known as methyl mercaptan, and occurs in Kraft pulp mill wastes. At certain concentrations and water temperatures it can be highly toxic to fish.</p>	Ref. 2		Chinook Salmon	Silver Salmon	Ct. Trout
		Water Temp. of test, °C.	15.5-19.5	12-18	9-15
		Minimum concentration for complete kill, mg/1.	0.9	1.75	1.2
		Maximum concentration for no kill, mg/1.	0.5	0.7	0.9
Methyl ethyl Ketone					
<p>This is a widely used liquid solvent in industry. It is used in the manufacture of synthetic resins, and is highly soluble in water. Bioassays indicate that at certain concentrations it is toxic to fish.</p>	Ref. 2	Water temp. of test, °C.	Bluegill 20.0	Gambusia 20.0	
		Fish adversely affected, 24 and 48 hours, , mg/1	3,380		
		TLm, 24 and 48 hours, mg/1	5,640		
		TLm, 24, 48 and 96 hours, mg/1		5,600	

TOXICITIES OF ELEMENTS AND COMPOUNDS

Remarks	Limits Water Quality Criteria	Effects on Fish		
Nitrate				
<p>A major problem with nitrate is eutrophication. Blooms of algae and other aquatic plants have severe economic and esthetic effects, affect fish and other aquatic life, including the killing of fish when a bloom dies and deoxygenation occurs, and cause serious problems in water treatment for domestic use. Blooms of algae and massive growths of other aquatic plants are possible when the nitrate content in the presence of other essential nutrients is about 0.5 mg/1 or more.</p> <p>Based on considerations of eutrophication alone, the following limits for nitrate are used.</p>	Ref. 2	Fresh Water	<p>Fish appear relatively indifferent to nitrate, although the associated nitrite can be toxic to them. Nitrite is an intermediate compound between nitrate and the more reduced forms of nitrogen and seldom persists long as nitrate, being readily oxidized or reduced.</p>	
	Goal	0.1 mg/1 above natural concentration		
	Standard	0.4 mg/1 above natural concentration		
	Goal	<0.6 mg/1		
	Standard	<0.6 mg/1		
		Salt Water		
	Ref. 4	10 ppm		
	Ref. 5	1.0 mg/1 (NO ³) 0.1 mg/1 (NO ²)		
Nitrogen				
<p>Water will absorb only a certain amount of nitrogen from the air at atmospheric pressure and at a given temperature. When the air is under pressure the water becomes supersaturated with dissolved gases (oxygen, nitrogen, and carbon dioxide). Excess nitrogen often occurs in spring or well water. It also may result from air entering the intake side of a water pump, or from air entering the intake of a gravity pipe line and being forced into solution by the gravity head on the line. It also occurs below falls, spillways and areas of excessive turbulence, all of which entrap air and carry the atmospheric gas to depth. Sudden warming of water may cause supersaturation.</p> <p>It is not always easy to remove immediately all excess nitrogen from a water supply. This can be done by vigorously breaking up the water so that excess gas is released to the atmosphere.</p>	Saturation		<p>Of the excess gases in supersaturated water, nitrogen is least tolerated by fish. Nitrogen is absorbed into the blood stream, causing gas bubbles which result in death of the fish. Fry will develop a visible gas bubble in the body cavity.</p>	
	Ref. 2	Fresh Water		
	Goal	Saturation at normal atm pressure		
	Ref. 4	110% (maximum total gas pressure)		
	Ref. 5	110% (total gas pressure) 103% (nitrogen gas)		

TOXICITIES OF ELEMENTS AND COMPOUNDS

Remarks	Limits Water Quality Criteria		Effects on Fish
Phenol and Phenolic Compounds			
<p>Phenolic wastes arise from the distillation of wood, from chemical plants, gas works, oil refineries and other industrial operations, as well as from human and animal refuse. Phenol is commonly used in the manufacture of synthetic resins and other industrial compounds. It is highly soluble in water.</p> <p>Phenol is biologically dissimilated in a concentration of 1.0 mg/1 at 20° C. in 1 to 7 days under aerobic conditions. At 4° C. (39.2 F) complete dissimilation required 5-19 days. Under anaerobic conditions dissimilation occurs at a slower rate.</p> <p>The U.S.P.H.S. Drinking Water Standards recommended limit of 0.001 mg/1 for phenol is primarily an esthetic limit, based upon the undesirable taste imparted to water by chlorination when even minute amounts of phenol are present.</p>	Ref. 2	Fresh Water	<p>Fish are reported to have been harmed by phenol concentrations as low as 0.079 mg/1. However, the taste of fish may be affected by subtoxic levels of phenol in the water.</p> <p>The reported lethal concentrations of phenolic compounds for fish vary widely not only because of the common variables such as species, temperature, time of contact, dissolved oxygen and mineral quality of water, but also because of synergistic and antagonistic effects of other substances in the water. Many phenolic substances are more toxic than pure phenol.</p>
	Goal		
	Standard		
		Salt Water	
	Goal		0.04 mg/1
	Standard		0.05 mg/1
Phosphates			
<p>Phosphates are of concern primarily because of the fact that phosphorus, being a fertilizer, frequently present naturally only in limited amounts, can contribute to the growth of aquatic organisms, especially when water is impounded. Such growths can reach severe nuisance proportions even with very small phosphate concentrations. Heavy algal blooms have been observed in lakes when the phosphate concentration exceeds 0.03 mg/1.</p>	Ref. 2	Fresh Water	<p>Phosphates are of no direct toxic significance to fish. However, like nitrogen compounds, they present a eutrophication problem. When a plant bloom dies and deoxygenation occurs fish kills may result.</p>
	Goal		
	Standard		0.15 mg/1
		Salt Water	
	Goal		0.3 mg/1
	Standard		0.4 mg/1
Potassium			
<p>Within the limits imposed by commonly accepted standards, potassium has a negligible effect on most beneficial uses of water.</p> <p>Some potassium is essential to plant nourishment, and it is commonly used as an ingredient (K₂O) in fertilizers to stimulate plankton growth in ponds. The range of concentration for this use is on the order of 0-5 mg/1.</p>	Ref. 2	Fresh Water	<p>Adverse effects upon fish are reported at potassium concentrations on the order of 50 mg/1, especially in soft water and water low in total salt content.</p>
	Goal		
	Standard		5.0 mg/1
		Salt Water	
	Goal		380 mg/1
	Standard		450 mg/1
	Ref. 5		5.0 mg/1
Radioactivity			
<p>The effects of radioactivity in surface waters are extremely complex. However, there appears to be no safe threshold below which no damage to man or other living organisms will result from exposure to ionizing radiation. Any exposure is detrimental. It appears that concentration is by far the most serious effect. Radionuclides in the aquatic or marine environment may effect organisms by (a) direct radiation from the water or accumulated bottom sediments, (b) absorption of radioactive material on the body surfaces, (c) absorption through cell membranes of soluble substances, and (d) ingestion or radionuclides along with food and water. For herbivores and carnivores, including fish, ingestion of radionuclides concentrated by lower forms of life appears to be the major route of accumulation.</p>	Ref. 2	Fresh and Salt Water	<p>Exposure to humans and fishes can be increased profoundly by consumption of food products such as shellfish or plankton, some of which concentrate radionuclides within themselves from large amounts of water.</p> <p>The present radioactivity in the Columbia River poses no direct somatic hazard toward fish.</p>
	Goal		

TOXICITIES OF ELEMENTS AND COMPOUNDS

Remarks	Limits Water Quality Criteria		Effects on Fish	
Selenium				
<p>The U.S.P.H.S. Drinking Water Standards impose a mandatory limit on selenium of 0.01 mg/1, based on toxicity.</p> <p>Plants can tolerate much more selenium than can humans. However, food crops will incorporate some selenium into the edible portions and selenium poisoning can result from eating the plants. This effect is not believed to be detectable when the concentration of selenium in irrigation water is below 0.01 mg/1.</p> <p>Stock and wildlife are susceptible to selenium poisoning, the result being known as alkali disease or blind staggers. This can result from ingestion of feed grown on selenium-rich soil, or from selenium-bearing water. It is believed that cattle can tolerate 0.4 to 0.5 mg/1 without showing toxic effects, and this probably represents the order of magnitude of tolerance of other animals.</p>	Ref. 2	Fresh Water	<p>Fish appear to be somewhat more sensitive to selenium than are humans. Quantitative data are scarce, but it would appear that the conservative limit established by the U.S.P.H.S. Drinking Water Standards for human consumption is probably acceptable for most, if not all, fish. Fish apparently concentrate selenium in their livers, as a result of ingestion of selenium which enters the food chain at the plankton level.</p>	
	Goal			Limit of detectability
	Standard			0.002 mg/1
		Salt Water		
	Goal			0.004 mg/1
	Standard			0.005 mg/1
	Ref. 5		0.01 mg/1	
	Ref. 6		1 µg/1	
Silver				
<p>The U.S.P.H.S. Drinking Water Standards mandatory limit on silver is 0.05 mg/1. This limit is based primarily on the cosmetic effect of silver excessive ingestion resulting in a permanent discoloration of the skin and eyes. From the effects of silver on humans, it would be expected that levels safe for human consumption would be entirely safe for terrestrial animals.</p>	Ref. 2	Fresh Water	<p>Fish are quite sensitive to silver, lethal effects having been observed at concentrations as low as 0.003 mg/1.</p> <p>Plankton appear to be somewhat less sensitive than fish, but the difference is slight and, from the limited data available, may be more apparent than real.</p>	
	Goal			Limit of detectability
	Standard			0.0004/mg/1
		Salt Water		
	Goal			0.0003 mg/1
	Standard			0.0004 mg/1
	Ref. 5	Fresh Water	0.003 mg/1	
		Salt Water	0.0003 mg/1	
	Ref. 6		.01 µg/1	
Sodium				
<p>Because sodium is a waste product of many beneficial uses of water and has little adverse effect upon water in limited amounts, the use of a river to carry sodium is of less importance than other additives.</p> <p>Sodium, like several other solutes in water, may indicate the presence of sewage of agricultural drainage. It is a conservative pollutant because most sodium salts are highly soluble and hence no removal occurs in either water treatment or sewage treatment processes. Where the natural sodium load is small the sodium concentration can serve as a pollution index.</p>	Ref. 2	Fresh Water		
	Goal			10/mg/1 over natural concentration
	Standard			35 mg/1 over natural concentration
		Salt Water		
	Goal			10,500 mg/1
Standard		12,500 mg/1		
	Ref. 5		75 mg/1	

TOXICITIES OF ELEMENTS AND COMPOUNDS

Remarks	Limits Water Quality Criteria		Effects on Fish		
Surfactants					
<p>Surfactants are also known as surface-acting agents or detergents. The surfactant formerly in widespread use in household washing products was ABS, which presented a considerable problem. The surfactant used almost exclusively since 1965 is LAS, which is more readily biodegradable.</p> <p>The U.S.P.H.S. Drinking Water Standards recommended limit for ABS is 0.5 mg/1. The substitution of terms and retention of the former limits would appear reasonable for LAS.</p>	Goal	Fresh and Salt Water	<p>Fish and aquatic organisms are subject to toxic effects of surfactants; the concentration necessary to produce such effects appear to be one or more orders of magnitude greater than the U.S.P.H.S. Drinking Water Standards (0.5 mg/1), for the most part.</p>		
	Standard	Trace		0.10 mg/1	
Zinc					
<p>The U.S.P.H.S. Drinking Water Standards recommended limit on zinc of 5.0 mg/1 is based on esthetic effects. Zinc is essential to human nutrition and, while toxic in large amounts, is not adverse physiologically within the range of esthetic acceptability.</p> <p>Zinc is essential to plant nutrition and, as with humans, can be toxic if present to excess. Values as low as 3 mg/1 have been observed to be harmful.</p> <p>The adverse effects of zinc to stock and wildlife are comparable to the effects on humans. Some synergistic effects appear to occur when zinc is present in combination with selenium, copper and possibly other materials.</p>	Ref. 2	Fresh Water	<p>Fish are strongly affected by zinc. Concentrations as low as 0.01 mg/1 have been observed to be lethal. The toxicity of zinc is greatest in soft water. Shellfish appear less sensitive to zinc than do swimmers, but are able to concentrate zinc from large amounts of water, possibly by ingestion of plankton which concentrate zinc from the water.</p>		
	Goal	Limit of detectability		Limit of detectability	
	Standard	Salt Water		0.01 mg/1	0.012 mg/1
	Goal	Soft Water		0.01 ppm	0.05 ppm
	Standard	Hard Water		0.01 ppm	0.05 ppm
	Ref. 4			0.01 ppm	0.05 ppm
Ref. 5			0.005 mg/1		
Ref. 6			0.03 mg/1		
Miscellaneous					
<p>There are a large number of miscellaneous toxicants that may be present in industrial effluents. These would include mercaptans, sulfides, resins, chlorine and residues from metal processing. These are also contained in pulp mill effluents. They can be readily reduced to near zero levels by effective effluent treatment. Because of their adverse effect and because they are amenable to removal from waste streams, concentrations of these effluents should not exceed the limits of reliable analytical detectability.</p>	Ref. 2	Fresh Water	<p>In addition to their direct toxic effects in fish, which may be considerable, some of these effluent products, as spent sulfite liquor, may exert indirect harmful effects such as deoxygenation and eutrophication.</p>		
	Goal	None detectable		None detectable	
	Standard	Salt Water		None detectable	None detectable
	Goal	None detectable		None detectable	None detectable
Standard	None detectable	None detectable	None detectable		

References Reviewed

1. McKee, Jack Edward, and Harold W. Wolf, "Water quality criteria." California State Water Quality Control Board, Publication 3-A. Second edition. Sacramento, California. 1963.
2. Sylvester, Robert O., and Carl A. Rambow, "Water quality of the State of Washington." Volume IV of "An Initial Study of the Water Resources of the State of Washington." Washington State Water Research Center, Pullman, Washington. 1967.
3. Jones, J.R. Eriksen, "Fish and River Pollution." Butterworths, London. 1964.
4. Washington Department of Fisheries. Water Chemistry. Upper limits for continuous exposure.
5. Oregon Department of Fish and Game. Water quality criteria for fish hatcheries in Oregon.
6. Environment Canada. "Canadian water quality guidelines." Prepared by the Task Force on Water Quality Guidelines. Ottawa, Ontario. March, 1987.

Chapter 14

Metals

Trace amounts of metals in natural waters.

Adverse effects of effluents from industrial plants.

Synergistic effects of two or more metal elements.

Types of piping in hatcheries and aquaria.

Check water quality before introducing new strains of fish.

References Reviewed.

METALS

Trace amounts of metals are found in various natural waters. Effluents from industrial plants may contain many heavy ions which could cause death or inhibit the growth of necessary plant life and food organisms. The recommended levels of these elements are shown in Chapter 17, "Toxicities of Elements and Compounds."

Synergistic effects are recognized and, when two or more metal elements are present, they may have adverse effects at much lower levels than either one individually. When they are found in combination, this factor should be considered.

In closed systems, such as aquaria and hatcheries, all copper piping should be avoided, as well as zinc-coated pipes. The presence of bronze in pump propellers, ring labyrinths and packing nuts should be avoided. Under

closed conditions, low levels of metals may accumulate in the animals with lethal effects.

Stainless steel of low numbers generally should be avoided.

Phenol treatment of wooden pipes should be avoided.

The formulae for paints should be obtained before their application in aquaria or closed systems to determine whether they contain metals.

As natural waters do carry trace metals to which certain strains of fish have become adapted, it is advisable to check water quality before introducing strains of fish not previously accustomed to such levels.

References Reviewed

1. Tarzwell, C.M., and C Henderson, "The toxicity of some of the less common metals to fishes." Excerpt from "Sanitary Engineering Aspects of the Atomic Energy Industry." (A seminar sponsored by the AEC and the Public Health Service, held at the Robert A. Taft Engineering Center, Cincinnati, Ohio, December 6-9, 1955.) U.S. Atomic Energy Commission Publication TID-7517 (Pt-Ia). U.S. Atomic Energy Commission, Washington, D.C. October, 1956.
2. California Department of Fish and Game, "Report on Mokelumne River pollution problems." Unpublished. Sacramento, California. January, 16, 1959.
3. Moore, G.T., and K.F. Kellerman, "Copper as an algicide and disinfectant in water supplies." U.S. Department of Agriculture, Bureau of Plant Industry, Bulletin 76. Washington, D.C. 1905.
4. Weatherley, A.H., J.R. Beevers, and P.S. Lake, "The ecology of a zinc-polluted river." In "Australian Inland Waters and Their Fauna," pp. 252-278, edited by A.H. Weatherley. Australian National University Press, Canberra. 1967.
5. Mount, Donald I., and Charles E. Stephan, "A method for detecting cadmium poisoning in fish." *Journal of Wildlife Management*, 31(1):168-172. January, 1967.
6. Lange, Norbert Adolph, comp., "Handbook of chemistry." 10th edition, p. 828. McGraw-Hill, New York. 1967.
7. Trama, F.B., "The acute toxicity of copper to the common bluegill (*Lepomis macrochirus* Raf.)." *Notulae Naturae* (Academy of Natural Sciences of Philadelphia), No. 257:1-13. February 17, 1954.
8. Mathews, A.P., "The relation between solution tension, atomic volume and physiological action of the elements." *American Journal of Physiology*, 10(6):290-323. February 1, 1904.
9. Weiss, C.M., "The comparative tolerances of some fouling organisms to copper and mercury." *Biological Bulletin*, 93(1):56-63. August, 1947.
10. American Water Works Association, "Water quality and treatment." Second Edition. American Water Works Association, New York. 1950.
11. Affleck, R.J., "Zinc poisoning in a trout hatchery." *Australian Journal of Marine and Freshwater Research*, 3(2):142-169. October, 1952.
12. Anderson, B.G., "The toxicity thresholds of various substances found in industrial wastes as determined by the use of *Daphnia magna*." *Sewage Works Journal*, 16(6):1156-1165. November, 1944.
13. Cairns, J., Jr., "Environment and time in fish toxicity." *Industrial Wastes*, 2(1):1-5. January-February, 1957.
14. Doudoroff, Peter, and Max Katz, "Critical review of literature on the toxicity of industrial wastes and their components to fish. II. The metals as salts." *Sewage and Industrial Wastes*, 25(7):802-839. July, 1953.
15. Domogalla, B., "Eleven years of chemical treatment of Madison lakes: its effect on fish and fish foods." *Transactions of the American Fisheries Society*, 65: 115-121. 1935.
16. Carpenter, K.E., "The lethal action of soluble metallic salts on fishes." *British Journal of Experimental Biology*, 4(4):378-390. June, 1927.
17. Ellis, M.M., "Detection and measurement of stream pollution." U.S. Bureau of Fisheries. Bulletin No. 22. 1937.
18. Doudoroff, Peter, "Some recent developments in the study of toxic industrial wastes." *Pacific Northwest Industrial Waste Conference, 4th Conference, Proceedings*, pp. 21-25. Washington State College, Pullman. 1952.
19. Katz, Max, Albert K. Sparks, Gary L. Pederson, C.E. Woelke, and James Woodey, "Effects of pollution on fish life - general aspects of water pollution biology." *Water Pollution Control Federation Journal*, 40(6): 1011-1012. June, 1968.

METALS

References Reviewed

20. Finn, J., "Saving fish from metal poisons." *Engineering News Record*, 125(1): 9 July, 1940.
21. Grindley, J., "Toxicity to rainbow trout and minnows of some substances known to be present in waste water discharged to rivers." *Annals of Applied Biology*, 33(1): 103-112. February, 1946.
22. Ellis, M.M., B.A. Westfall, and M.D. Ellis, "Determination of water quality." U.S. Fish and Wildlife Service, *Research Report No. 9*. 1948.
23. Hublou, Wallace, F., James W. Wood, and Ernest R. Jeffries, "The toxicity of zinc or cadmium for chinook salmon." *Oregon Fish Commission, Research Briefs*, 5(1):8-14. March, 1954.
24. Jones, J.R.E., "A study of the zinc-polluted river Ystwyth in North Cardiganshire, Wales." *Annals of Applied Biology*, 27(3):368-378. August, 1940.
25. Thomas, A., "Effects of certain metallic salts upon fishes." *Transactions of the American Fisheries Society*, 44:120-124. 1915.
26. Vernon, E.H., "The toxicity of heavy metals to fish, with special reference to lead, zinc and copper." *Canadian Fish-Culturist*, No. 15:32-7. April, 1954.
27. Dorfman, D., and W.R. Whitworth, "Effects of fluctuations of lead, temperature, and dissolved oxygen on the growth of brook trout." *Fisheries Research Board of Canada Journal*, 26(9):2493-2501. September, 1969.
28. Dilling, W.J., and C.W. Healy. "Influence of lead and the metallic ions of copper, zinc, thorium, beryllium, and thallium on the germination of frog's spawn and on the growth of tadpoles." *Annals of Applied Biology*, 13(2):177-188. May, 1926.
29. Roberts, Harold, "Cadmium toxic to rainbow trout." *The Progressive Fish-Culturist*, 25(4):216. October, 1963.
30. Dunstan, William A., "Copper sulfate treatment of the Cedar River and tributaries." In *Washington Department of Fisheries "Progress Report, Puget Sound Stream Studies."* Unpublished report by W.E. Bostick, W.A. Dunstan, and W.H. Rees, pp. 6-15. 1956.
31. Goodman, J.R., "Toxicity of zinc for rainbow trout (*Salmo gairdnerii*)." *California Fish and Game*, 37(2): 191-194. April, 1951.
32. Copeland, Richard, "The mercury threat: questions to consider." *Limnos*, 3(2):11-13. Summer, 1970.
33. "The quicksilver crisis." *Newsweek*, 76(5):61. August 3, 1970.
34. Seagran, Harry L., "Mercury in Great Lakes fish." *Limnos*, 3(2):3-10. Summer, 1970.
35. Wilber, Charles G., "The biological aspects of water pollution." Charles C. Thomas. Springfield, Illinois. 1969.
36. Wobeser, G., N.O. Nielsen, and R.H. Dunlop, "Mercury concentrations in tissues of fish from the Saskatchewan River." *Fisheries Research Board of Canada, Journal*, 27(4):830-834. April, 1970.

Chapter 15

Plastics

Importance of properties.

Toxicity studies:

U.S. Bureau of Sport Fish
and Wildlife,
Fish Control Laboratory,
La Crosse, Wisconsin

Marine Science Center,
Oregon State University,
Newport, Oregon

Point Whitney Laboratory,
Washington Department of Fisheries

Plastic materials toxic to fish.

Plastic materials non-toxic to fish.

References Reviewed.

PLASTICS

The use of plastic materials in all phases of aquaculture should be approached with caution. Some of these substances may offer some advantages over older, more conventional materials, chiefly their light weight and durability and the fact that most of them can be produced in molded form. Experience has shown, however, that their properties, particularly their reaction to waters of various quality and their effects on aquatic organisms, are not always innocuous. This applies even to substances that are described as inert and non-toxic for most uses.

Generally, the pure polymers are non-toxic, but additives may be responsible for toxic reactions to fish. In addition to known highly toxic additives, as tricresyl phosphate, the manufacturing process may incorporate various pigments, dyes, fillers or stabilizers which have unknown toxic effects on fish and other aquatic organisms. Further, many of these products have a surface coating of paint, lacquer or varnish which in itself may be highly toxic. The major hazard arising from such a coating is associated with the presence of heavy metals, especially lead, although cadmium, barium, chromium, antimony, and various organic dyes frequently are employed, with possible toxic results.

Another plastic material, polyvinyl chloride, is virtually inert in itself, yet chemicals introduced in the compounding of the polymer, including fillers, stabilizers, pigments, etc., may produce toxic hazards to fish. (Reference No. 1.) Thus products made of polyvinyl chloride may or may not be toxic to fish, depending upon the manufacture. It becomes apparent that frequently one cannot generalize on the toxicity of certain classes of these compounds.

The U.S. Bureau of Sport Fisheries and Wildlife, Fish Control Laboratory, La Crosse, Wisconsin, has reported a well documented incident of the toxicity to fish of an epoxy cement used to bind fiberglass screen holders to troughs. The cement consisted of an epoxy resin, an amide hardener, and methyl ethyl ketone as a thinner. This combination proved extremely toxic to both rainbow trout and goldfish. The conclusion was that, even in a constantly changing water supply, such a cement should be thoroughly hardened and well flushed or leached before it is used with fish. (Reference No. 3.)

Fishery research investigators at the Marine Science Center, Oregon State University, at Newport, Oregon, found that in their work on the culture of the larvae of the bay mussel there was a great deal of variation in the toxic effects of the same class of plastic compound produced by different manufacturers.

The phenoxy resins have Food and Drug Administration acceptability for all food contact uses. (Reference No. 2.) Since aqueous solutions of either high or low pH value do not attract phenoxy, it should be in itself rather inert and non-toxic.

The ABS resins have been found to be toxic to fish.

Even such an inert substance as polyethylene surgical tubing has been known to produce a toxic reaction in man, called thrombophlebitis, after prolonged intravenous use. (Reference No. 1.) Such materials should be leached in running water for a considerable time before being brought into close contact with fish or other aquatic organisms.

High strength plastic pipe, when used, has not shown toxicity.

Shellfish research investigators at the Point Whitney Laboratory of the Washington Department of Fisheries have conducted toxicity studies on a great many plastic materials. These were undertaken in conjunction with bioassays of 48-hour oyster embryos. It should be pointed out that the toxic effects were based on embryonic development and not on the metabolic processes occurring in feeding. Their most significant conclusion was that there was no consistency in the toxic effects encountered; different lots of the same basic plastic material, from the same manufacturers, have varying results. However, some general conclusions were made which, it should be cautioned, do not eliminate the necessity for checking the toxicity of each new lot of plastic material used. The studies at the Point Whitney Laboratory indicated the following:

Polyethylene sheeting generally is non-toxic.

Polyvinyl chloride sheeting generally is toxic.

The rigid polyvinyl-chloride extrusions usually are non-toxic.

Polyvinyl-chloride piping generally has been non-toxic in the past; a new formulation has not been checked.

Based on limited testing, Teflon sheeting was non-toxic.

Saran piping, poly-propylene rope, and fiberglass are non-toxic.

Aged neoprene sheeting and aged neoprene innertubes are toxic.

References Reviewed

1. "Symposium on toxicity in plastics." In *The Plastics Institute, Transactions and Journal*, 35(116):447-455. April, 1967.
2. *Modern Plastics Encyclopedia*. Modern Plastics, New York. 1966.
3. Mairs, Donald F., "Toxicity of an epoxy cement to fishes." *The Progressive Fish-Culturist*, 23(4):178. October, 1961.
4. Brydson, J.A., "Plastic materials." Van Nostrand, Princeton, New Jersey. 1966.

Chapter 16

Pesticides and Herbicides

Must be judiciously applied.

Some pesticides have been discarded because of inherent danger.

Some organisms develop strains immune to certain pesticides.

Many solvents, diluents and other carriers used with pesticides also have toxic properties.

An important factor to be considered is the biological magnification.

In making judgement, it is necessary to measure toxicity of a compound in a specific environment.

Insufficient data available on toxicity, both short term and cumulative, of more than a few common pesticides or their degradation products.

Establishment of tolerable concentration of pesticides for fish requires consideration of food chain accumulation.

Chlorinated hydrocarbons more toxic to fish.

Organic phosphates are generally, but not always, less toxic to fish.

Sevin (of the carbamate group of chemicals) shows low toxicity to mammals and fish.

Herbicides, in general, are less toxic to fish than insecticides.

Inorganic herbicides are being replaced in many areas by more effective proprietary organic products.

Various aromatic solvents also used.

Particular major concern in any consideration of effects of pesticides on aquatic biota are conditions that may prevail in river estuaries which suffer cumulative effects of pesticide residues.

References Reviewed.

PESTICIDES and HERBICIDES

The term "pesticide" in its broad connotation may include any substance used for the control of unwanted or harmful animal and plant life. If they are not judiciously applied, the secondary or side effects of many pesticides may be extremely harmful to fish, man and the entire ecological environment. These harmful effects have been increasingly recognized, unfortunately, mainly because of disasters to the biota, and a better understanding has developed for the needs of pesticide application controls and permissible concentrations in surface waters. Some pesticides have been discarded because of inherent danger, long-term residual toxicities, or cumulative toxic build-up that affects other organisms.

Some target organisms are known to develop strains that are immune to certain pesticides. New and improved chemical compounds are constantly being developed, together with a better awareness of the problems encountered in pesticide use.

The literature is extensive on the occurrence of fish kills and the effects on the biota of the injudicious use of pesticides. A considerable amount of research has been conducted on toxic effects on fish of a vast number of pesticides at various concentration levels, as well as on their residual qualities, the toxic build-up in aquatic organisms caused by prolonged exposure to sublethal concentrations of pesticides, and the transfer effects to other animals, both wild and domestic.

Without attempting to list or describe all of the known pesticide formulations now or formerly used, consideration is given to the principal classes of these products and their effects on fish and other aquatic organisms.

Many solvents, diluents and other carriers used with pesticides also have toxic properties. Solvents, such as xylene, alkylated naphthenes, fuel oil and kerosene, have some toxicity. This effect is believed to be particularly evident in aquatic environments when solvents have an opportunity to be emulsified by ripples in streams. (Reference No. 1.)

The addition of synergists and/or various adjuvants to make a particular pesticide more effective has been practiced by the pesticide manufacturing industry for many years. For example, sulfoxide is used as an effective synergist with rotenone. Adjuvants include wetting or spreading agents, stickers, penetrants and emulsifiers. (See Reference No. 1.)

An important factor that must be considered in the effects of pesticides is the biological magnification. This occurs particularly with the chlorinated hydrocarbons. While DDT has been banned, sufficient experiments have been conducted with it that it may be used as an example of biological magnification. Many animals, including fish (and especially oysters) have the ability to remove organochlorides present at sublethal levels in the surrounding water and store them in their fatty tissues. Death occurs when the animal's food supply is restricted, the body fat is mobilized and the pesticide that is stored in the fat depots of the body is released into the bloodstream. Equally disastrous is the mobilization of such body fats to form sex products, which may contain sufficiently high levels of the pollutant so that normal development of the young is impossible.

Another serious effect of the biological magnification and storage of toxic residues, for example, is that fish may

gradually build up DDT residues of 15 to 20 mg/1 without apparent ill effect, but other fish, mammals and birds preying on contaminated fish may be killed immediately or suffer irreparable damage. Long term or chronic toxicities, therefore, are more insidious and difficult to define than acute toxicities. Both types for a given compound vary, however, with water temperature, water chemistry and biological factors such as age, sex, size and condition, as well as with the species of fish affected. In making a judgment, it is necessary to measure toxicity of a compound in a specific environment, or to have an estimate of all these factors. Reference No. 3 gives an excellent list of the toxicity levels of most of the common pesticides.

Because of these complicated factors, there are insufficient data available on the toxicity, both short-term and cumulative, of more than a few common pesticides or their degradation products. Because of their known toxicity it is imperative that the introduction of pesticides or their residues to surface waters be rigidly controlled and minimized by all available means. (See Reference No. 4.)

In Reference No. 6, it is recommended that in the absence of toxicity data, other than the 96-hour TL_M, an arbitrary application factor of 1/100 of this amount should be used as the criterion of permissible levels.

In Reference No. 2, it is pointed out that since fish can concentrate chlorinated hydrocarbons up to 10,000 times, the water quality criteria for these substances should be based on this biological magnification and not on the TL_M (50). However, establishment of tolerable concentrations of pesticides for fish requires the consideration of food-chain accumulation, tissue residues rendering the fish unfit for consumption, potential hazard to fish from reabsorption of fat-stored pesticides, and off-tastes or tainting from certain types of pesticides.

The two main groups of synthetic pesticides are the chlorinated hydrocarbons and the organic phosphates. The chlorinated hydrocarbons are the more toxic to fish. Many are stable, not metabolized or excreted to any degree, and remain stored in tissues. As residues in soil and marine sediments, they may persist unchanged for many years and, consequently, present a continuing threat to animal communities. As a general rule, the acute toxicity of this group of pesticides increases with the level of metabolic activity so that their presence may cause two or three times more damage in summer than in winter.

The organic phosphates are generally, but not always, less toxic to fishes. Some have a remarkable synergistic effect, as EPN and malathion, which together have an increased acute toxicity of 50-fold. Typically, they hydrolyze or break down into less toxic products much more readily than the chlorinated hydrocarbons. Practically all persist for less than a year while some last only a few days in the environment. Most are degraded rather quickly in warm water and, consequently, are more hazardous to aquatic animals at winter than at summer temperatures.

The carbamate group of chemicals includes one common insecticide called "Sevin." Its acute toxicity to both mammals and fish is quite low and it does not appear to present any problem for fish in the concentrations normally used. The 96-hour TL_M value for bluegills was 11.0 mg/1, and for fathead minnows, 41.0 mg/1, at 25 C., using the commercial grade of Sevin, a 50 percent wettable powder. (See Reference No. 1.)

PESTICIDES and HERBICIDES

The other major group of chemical products that frequently affect fish is the herbicides. These can be divided into inorganic products, such as sodium arsenite, copper sulfate and mercuric chloride (corrosive sublimate) and organic products, such as Aqualin, Dichlobenil, Dichlone and many others

Herbicides, in general, are less toxic to fish than insecticides, although there are some notable exceptions, as toxaphene. The inorganic herbicides are being replaced in many areas by some of the more effective proprietary organic products.

Copper sulfate is a commonly used algicide. Its toxicity to fish varies markedly with the water chemistry and it is about ten times more toxic to rainbow trout in soft waters (12 mg/1 as CaCO_3) than in hard waters. The sulfates of copper and zinc and those of copper and cadmium are synergistic in soft waters in their toxic effect on fish.

Several rosin amine compounds are used as algicides. Rosin amine D acetate is sold under the proprietary name of Delrad and is also known as RADA. It is toxic to various fish species at 0.4 to 0.7 mg/1. (See Reference No. 1.)

Various aromatic solvents also are used for the control of submerged aquatic plants, particularly in irrigation canals. Some of these petroleum or coal-tar derivatives are quite toxic to fish, as well as to other aquatic life. In aquaria, Socal No. 3 at 4.2 mg/1 killed from 40 to 60 percent of the white crappies tested. Ortho Aquatic Weed Killer, which is 95 percent aromatic petroleum distillate, had a LD50 of 50mg/1 in 72 hours with 3-inch silver salmon. (See Reference No. 1.)

The acute toxicity to fish of several commonly used herbicides, namely endothal, diquat, hyamine, dalapon and silvex is reported in Reference No. 5.

The use of 2,4-D has been successful in the control of water hyacinth and other emergent water weeds. It is perhaps the most widely used chemical compound for weed control, and is not acutely toxic to fish. In laboratory tests, the lowest concentration of 2,4-D that caused mortality was 100 mg/1. However, certain esters and amines of 2,4-D have been found to be more toxic and, particularly in still, shallow water, may harm fish at dosages used for weed control. (See Reference No. 1.)

Of particular major concern in any consideration of the effects of pesticides on the aquatic biota are the conditions that may prevail in river estuaries. These estuarine areas suffer the cumulative effects of pesticide residues brought in from long distances upstream. In addition to the long-term residual toxic properties of some of the chemical products deposited in the estuaries, there are synergistic effects that result when some of these products are brought together in this generally favorable environment. The estuaries are extremely important reproduction and living areas in the early life stages of many of our economically important fish and shellfish. The marine crustaceans, such as crabs, lobsters and shrimp, are extremely sensitive to the array of insecticides to which they are exposed. The mollusks are also affected and accumulate large amounts of sublethal concentrations of toxicants in their fatty tissues. In general, shrimp are much more sensitive than fish or oysters to all types of pesticides. For this reason, the Federal Water Pollution Control Administration uses shrimp as a yardstick for establishing safe levels of pesticides that might be expected as toxicants in the marine environment.

PESTICIDES and HERBICIDES

References Reviewed

1. McKee, Jack Edward, and Harold W. Wolf, "Water quality criteria." California State Water Quality Control Board, Publication 3-A. Second edition. Sacramento, California. 1963.
2. Katz, Max, Albert K. Sparks, Gary L. Pederson, C.E. Woelke, and James Woodey, "Effects of pollution on fish life - general aspects of water pollution biology." In "A Review of the Literature of 1967 on Wastewater and Water Pollution Control." Water Pollution Control Federation, Journal, 40(6):1007-1122. June, 1968.
3. Johnson, Donald W., "Pesticides and fishes - a review of selected literature." American Fisheries Society, Transactions, 97(4):398-424. October, 1968.
4. Sylvester, Robert O., and Carl A. Rambow, "Water quality of the State of Washington." Volume IV of "An Initial Study of the Water Resources of the State of Washington." Washington State Water Research Center, Pullman, Washington. 1967.
5. Surber, Eugene W., and Quentin H. Pickering, "Acute toxicity of endothal, diquat, hyamine, dalapon, and silvex to fish." The Progressive Fish-Culturist, 24(4): 164-171. October, 1962.
6. U.S. Federal Water Pollution Control Administration, "Water quality criteria: report of the National Technical Advisory Committee to the Secretary of the Interior." Washington, D.C. April, 1958.
7. Rudd, Robert L., "Pesticides and the living landscape." University of Wisconsin Press, Madison. 1964.
8. Hopkins, C.L., S.R.B. Solly, and A.R. Ritchie, "DDT in trout and its possible effect on reproductive potential." New Zealand Journal of Marine and Freshwater Research, 3(2):220-229. June, 1969. (Reprinted as Fisheries Research Publication No. 130.)
9. Anderson, John M., "Effect of sublethal DDT on the lateral line of brook trout, *Salvelinus fontinalis*." Fisheries Research Board of Canada, Journal, 25(12): 2677-2682. December, 1968.
10. Mount, Donald I., "Considerations for acceptable concentrations of pesticides for fish production." In American Fisheries Society, Special Publication No. 4:3-6, "A symposium on water quality criteria to protect aquatic life." Supplement to Transactions of the American Fisheries Society, 96(1). January, 1967.
11. Workman, G.W., and J.M. Neuhold, "Lethal concentrations of toxaphene for goldfish, mosquitofish and rainbow trout, with notes on detoxification." The Progressive Fish-Culturist, 25(1):23-30. January, 1963.
12. Anderson, Richard B., and W. Harry Everhart, "Concentrations of DDT in landlocked salmon (*Salmo salar*) at Sebago Lake, Maine." Transactions of the American Fisheries Society, 95(2):160-164. April, 1966.
13. Stout, Virginia, "Pesticide levels in fish of the Northeast Pacific." Bulletin of Environmental Contamination and Toxicology, 3(4):240-246. July-August, 1968.
14. Henderson, C., and Q.H. Pickering, and C.M. Tarzwell, "Relative toxicity of ten chlorinated hydrocarbon insecticides to four species of fish." Transactions of the American Fisheries Society, 88(1):23-32. January, 1959.
15. Nicholson, H. Page, "Pesticide pollution control." Science, 158(3803):871-876. November, 1967.
16. Butler, Philip A., "Pesticides in the marine environment." Journal of Applied Ecology, 3(Supplement):253-259. 1966.
17. Willbord, Wayne A., Joe B. Sills, and Everett W. Whealdon, "Chlorinated hydrocarbons in the young of Lake Michigan coho salmon." The Progressive Fish-Culturist, 31(4):220. October, 1969.
18. Cope, Oliver B., "Contamination of the freshwater ecosystem by pesticides." Journal of Applied Ecology, 3(Supplement):33-44. 1966.
19. George, J.L., and D.E.H. Frear, "Pesticides in the Antarctic." Journal of Applied Ecology, 3(Supplement): 155-167. 1966.
20. Tatton, J., and J.H.A. Ruzicka, "Organochlorine pesticides in Antarctica." Nature, 215(5099):346-348. July, 1967.
21. DeVaney, Thomas, E., "Chemical vegetation control manual for fish and wildlife management programs." U.S. Bureau of Sports Fisheries and Wildlife, Resource Publication No. 48. January, 1968.
22. U.S. Fish and Wildlife Service, "Pesticide-wildlife studies - a review of Fish and Wildlife Service investigations during 1961 and 1962." Circular 167. June, 1963.
23. Hickey, Joseph J., J.A. Keith, and Francis B. Coon, "An exploration of pesticides in a Lake Michigan ecosystem." Journal of Applied Ecology, 3(Supplement): 141-154. 1966.
24. Saunders, J.W., "Mass mortalities and behavior of brook trout and juvenile Atlantic salmon in a stream polluted by agricultural pesticides." Fisheries Research Board of Canada, Journal, 26(3):695-699. March, 1969.
25. Weiss, Charles M., and Jack H. Gakstatter, "The decay of anticholinesterase activity of organic phosphorus insecticides on storage in waters of different pH." Water Pollution Control Federation, Journal, 36(3):274-275. March, 1964.
26. Stober, Q.J., and W.R. Payne, Jr., "A method for preparation of pesticide-free fish food from commercial fish food pellets." Transactions of the American Fisheries Society, 95(2):211-214. April, 1966.
27. St. Amant, James A., William C. Johnson, and Marvin J. Whallis, "Aqualin as a fish toxicant." The Progressive Fish-Culturist, 26(2):84-88. April, 1964.
28. MacPhee, Craig, and Richard Ruelle, "A chemical selectively lethal to squawfish (*Ptychocheilus oregonensis* and *P. umpqua*)." Transactions of the American Fisheries Society, 98(4):676-684. October, 1969.

PESTICIDES and HERBICIDES

References Reviewed (Continued)

29. Cope, Oliver B., Edward M. Wood, and George H. Wallen, "Some chronic effects of 2,4-D on the bluegill (*Lepomis macrochirus*)." *Transactions of the American Fisheries Society*, 99(1):1-12. January, 1970.
30. U.S. Department of Agriculture, Agricultural Library, "The toxicity of herbicides to mammals, aquatic life, soil microorganisms, beneficial insects and cultivated plants, 1950-65; a list of selected references." Library list No. 87. U.S. Government Printing Office, Washington, D.C. 1968.
31. Mellanby, Kenneth, "Pesticides and pollution." Collins, London, England. 1967.
32. Jones, J.R. Ericksen, "Insecticides and herbicides" in his "Fish and River Pollution," Chapter 11, pp. 128-141. Butterworths, London. 1964.
33. Goudey, R.F., "Chemical weed control." *American Water Works Association, Journal*, 38:115-121. 1946.
34. Domogolla, B., "Scientific studies and chemical treatment of the Madison lakes." In "Symposium on Hydrobiology," edited by J.G. Needham and others, pp. 303-310. University of Wisconsin Press, Madison. 1941.
35. Surber, E.W., "Chemical control agents and their effects on fish." *The Progressive Fish-Culturist*, 10(3): 125-131. July, 1948.
36. Gilderhus, Philip A., "Effects of diquat on bluegills and their food organisms." *The Progressive Fish-Culturist*, 29(2):67-74. April, 1967.
37. "Effects of pesticides on fish and wildlife, 1964 research findings of the Fish and Wildlife Service." U.S. Fish and Wildlife Service, Circular 226. Washington, D.C. August, 1965.
38. Wilber, Charles G., "The biological aspects of water pollution." Charles C. Thomas, Springfield, Illinois. 1969.

Chapter 17

Fish Toxicants

Caution to be followed in using a toxic substance.

Toxicants:

Rotenone

Antimycin A (Fintrol)

Chlorinated Hydrocarbon
Compounds

Organophosphates

Sodium Cyanide

Cresol

Selective toxins

Thanite

Table A. Conversion table to determine number of 50-pound bags per 1,000 pounds when rotenone content varies between 5 and 10%.

References Reviewed.

FISH TOXICANTS

In using any toxic substance, it is cautioned that at least two sources be checked for concentration limits to insure that no damage to human, animal or plant life results. In most cases, competent technicians should be employed to apply toxicants. People not associated with the work in general should be excluded during the operation.

Rotenone

Rotenone is the most widely used and accepted fish toxicant because it is effective, comparatively nontoxic to most mammals, rapidly degradable, fairly economical and usually has no permanent serious effects on the nontarget biota. Reasonable care should be used in handling and applying rotenone, however, since eye inflammation and skin irritation may occur from continuous exposure to the dry, powdered form. Persons exposed to emulsifiable rotenone spray should wash immediately exposed skin surfaces.

The powdered form, usually containing 5 to 20 percent of the active rotenone ingredient, may be the most economical if manpower requirements for application are discounted. However, the toxicity of the dry, powdered root is known to decline in storage, especially at higher air temperatures.

The liquid, emulsifiable rotenone products available commercially remain stable in sealed metal containers, and have the advantage of easier application; however, the price is higher than that of the powdered root.

Special commercial formulations of emulsifiable rotenone also are available and have some advantages in certain situations. One commercial preparation disperses more rapidly in both a downward and horizontal direction and, therefore, is better adapted to deep waters.

Some commercial preparations contain synergists which, it is reported, produce equally toxic effects with a lesser amount of the rotenone ingredient. One of the synergists used is piperonyl butoxide. Another preparation uses sulfoxide as a synergist. Comparative results vary in different bodies of water with the synergistic products and those containing only rotenone, other cube extractives, and the carrier. It should be pointed out, however, that any of the emulsifiable, liquid rotenone preparations available may impart an undesirable taste to fish salvaged for food. This may be a considerable factor in favor of using the dry, powdered root where a large kill of desirable food fish is anticipated.

There are several simple arithmetic methods of determining the amount of rotenone needed to produce a desirable toxic level in a body of water, using either the dry, powdered root or the liquid, emulsifiable preparation. There are also some short cut methods that are convenient in field work. Correction tables are available that allow for variations in the actual amount of toxic ingredients, as well as nomographs for quick determination of the rate of disposal required for running waters and amounts of toxicant required.

Small ponds usually are measured in cubic feet and total pounds of water (1 cu. ft. = 62.4 lbs).

$$\frac{62.4 \times \text{cu. ft. of water}}{1,000,000} = \text{lbs. of dry root required for 1 ppm}$$

For larger water areas:

$$\text{Surface acres} \times \text{av. depth in feet} \times 2.72 = \text{lbs. dry root required for 1 ppm (5\% rotenone content).}$$

Using emulsifiable (liquid) rotenone:

$$1 \text{ gal. emulsive per 3 acre feet} = 1 \text{ ppm by volume or } 0.328 \text{ gal. (2.6 pints) per acre foot} = 1 \text{ ppm by volume.}$$

The rotenone concentration required to obtain a complete kill varies with a number of factors, including the target species, water temperature, water quality, pH, turbidity and dissolved oxygen. The required concentration will range between 0.5 and 2.0 ppm. A minimum concentration of 0.5 will give good results with most species of fish under favorable conditions; that is, when the water temperature is not higher than 55 to 60 F. from top to bottom, the pH is near neutral, the dissolved oxygen is low and the water is not turbid. If carp, catfish or other resistant species are present it may be necessary to use a concentration of 1 to 2 ppm, with repeated treatment to eradicate them, particularly if there are springs or other uncontrollable sources of untreated water inflow.

Rotenone exhibits selective toxic effect on some species of fish at certain concentration levels. Temperature and water chemistry also are critical factors in obtaining a selective toxic effect. In managing mixed populations of warmwater species, it is often possible to obtain a selective action with rotenone, as in the control of gizzard and thread-fin shad. (Reference No. 17.)

Special rotenone preparations are available that will or will not penetrate the thermocline readily. Although trout are very sensitive to rotenone, low levels of concentration (0.025 to 0.01 ppm) have been used to reduce the population of warmwater fish in the epilimnion without harming trout in the hypolimnion.

Antimycin A (Fintrol)

Antimycin is a powerful antifungal antibiotic that was developed at the University of Wisconsin. Since 1963, the Bureau of Sports Fisheries and Wildlife Fish Control Laboratory at La Crosse, Wisconsin has conducted extensive laboratory and field tests of Antimycin A as a fish toxicant. (Reference No. 13.) This work has shown that Antimycin A has some very remarkable properties as a fish toxicant. It is absorbed into the gills of fish and kills by interfering with the respiration of body cells. Its action is irreversible and, once a fish has had brief exposure, it is doomed.

Only very small quantities of the substance are required to cause lethal effects with fish, a concentration of 1 to 5 parts per billion being sufficient with most of the species tested. Antimycin A kills fish at both cool and warm water temperatures, a but toxicity increases with water temperature. It does not repel fish. Plankton, aquatic plants, amphibians and bottom fauna are not affected by the concentrations used to kill fish. Its toxicity to mammals is very low. It degrades rapidly in water and detoxification occurs within 24 to 96 hours. The toxicant is slightly more effective in soft waters.

An important feature of Antimycin A is that it can be used as a selective toxicant if applied at the proper concentration

FISH TOXICANTS

level. Carp, pumpkinseed and bluegill sunfish are among the species more sensitive to Antimycin A. Freshwater catfish are among the less sensitive species. In one field experiment, large populations of carp and green sunfish were completely eradicated by a concentration that allowed northern pike and largemouth bass to survive.

Antimycin A is also toxic to fish eggs at somewhat higher concentrations. This is a marked advantage in some trash fish eradication projects.

Antimycin A can be readily detoxified by the use of potassium permanganate. In one test, 10 parts per billion of toxicant were deactivated by one part per million of potassium permanganate.

Since the antibiotic was shown to be extremely toxic at concentrations as low as 1 µg/l (parts per billion), a problem arose in obtaining adequate dispersal of the small amounts required. This led to the formulation of Antimycin A on sand to facilitate dispersal, and in application to temperature-stratified and/or weed-infested waters.

Another interesting feature of Antimycin A shown by work at the La Crosse Fish Control Laboratory is its synergistic interaction with rotenone. The toxic effect of Antimycin A occurs more slowly than that of rotenone. However, the LC50 (lethal concentration causing 50 percent mortality in a specified time) after 48 hour and 96 hour exposures of rainbow trout and bluegill to 12 C. (53.6 F.) showed that the combination of Antimycin A and rotenone is more toxic than either of these toxicants alone. (Reference No. 12.)

In summary, Antimycin A at concentrations ranging from 0.1 µg/l to 2.0 µg/l, depending on pH and water temperature, will highly sensitive species such as trout, perch, herring and gizzard shad. Slightly less sensitive species, as carp, minnows and sunfishes, may be effectively controlled at concentrations of 2.0 µg/l to 10.0 µg/l. Highly resistant species, as freshwater catfish, gars and bowfins may require concentrations of 10.0 µg/l to 20.0 µg/l, depending on water conditions.

The possible disadvantages to the use of Antimycin A are two. First, a rapid degradation of the antibiotic occurs under some field conditions, particularly where the pH is high (approaching 10) and there is an abundance of free hydroxyl (OH) ions. Under such conditions, the rapid degradation of the toxicant has been known to allow some fish to escape. Second, Antimycin A, used at the recommended concentrations, at present is much more expensive than rotenone. When formulated with sand as a carrier, it is bulky and heavy, resulting in high shipping costs.

The Wisconsin Alumni Research Foundation licensed the Ayerst Laboratories, New York, to produce and market Antimycin. The commercial product is called "Fintrol." It was registered as a toxicant in June, 1966 and has been approved by the Pesticide Regulations Division of the United States Department of Agriculture for use in freshwater fishery management.

Chlorinated Hydrocarbon Compounds

Many of the organic pesticides, and particularly the chlorinated hydrocarbon compounds, have been used at higher than normal concentrations as fish toxicants. They have the same objectionable features as piscicides that they

present as pesticides; i.e., their long-lasting toxicity, transfer and build-up effects on other portions of the biota.

The most commonly used chlorinated hydrocarbon insecticide, which also has been widely used as a piscicide, is toxaphene (chlorinated camphene). Toxaphene is very effective and economical as a fish toxicant, as it is lethal to all species at about 0.2 ppm and to trout at much lower concentrations, depending on water quality and physical conditions. (Reference No. 22.) However, wide variations have occurred in the length of time lentic waters have remained toxic after treatment with toxaphene; some waters have remained toxic for a year or more. For this reason, and also because of the effects on the entire biota, including cumulative toxic effects in the food chain, the use of toxaphene as a fish toxicant has been largely discontinued by most fishery managers.

The herbicide, acrolein (Aqualin), has been used experimentally as a fish toxicant. It is effective against most species, including carp, at 3 ppm, but is more expensive than rotenone. (Reference No. 21.)

Endrin, a chlorinated hydrocarbon insecticide, also has been used as an effective fish toxicant at very low concentrations. The same objections apply to endrin as a piscicide that apply to other chlorinated hydrocarbon compounds.

Organophosphates

Recent research indicates that some organophosphates, including Ethyl Guthion, GC-3582 and GC-3583, may offer outstanding possibilities for the control of trash fish. These materials are known to be unstable in water and are believed to have little or no accumulation tendency in nontarget components of the biota. (Reference No. 10.)

It has been shown recently that Bayer 73 (commercial Bayluscide), an effective molluscicide, is also highly toxic to at least 18 species of freshwater fish. Various temperatures and water qualities in static bio-assays do not influence the toxicity greatly, but pH variations in chemically-buffered solutions do. The biodegradability, efficacy and relative safety of Bayer 73 indicate its possible future usefulness as a general fish toxicant. (Reference No. 15.)

Sodium Cyanide

Another chemical that is very effective as a fish toxicant is sodium cyanide. (See Reference No. 9.) It is not used extensively because it has not been approved by the U.S. Food and Drug Administration. Approval has not been given because of possible potential danger to the applicator. When sodium cyanide is dissolved in water, it forms hydrocyanic acid and may release a small amount of hydrogen cyanide gas at the surface. Lethal amounts of this gas are released if the chemical comes in contact with an acid.

Cresol

Commercial cresol has been used in some areas, mainly as a fast-acting means of sampling fish populations in small streams. It provides a useful collection method in streams where the low conductivity of the water renders electric shocking methods ineffective.

Cresol is available in various concentrations, based on its phenol equivalent as a disinfectant. The most efficient

FISH TOXICANTS

use is obtained from the highly concentrated phenolic emulsifiable disinfectant (coefficient 30). It should be cautioned that this highly toxic to humans and extreme care should be taken to avoid contact of the chemical with any part of the body.

The application rate is determined by stream velocity, volume, temperature and water quality; however, 1 gallon of cresol (p.e. 30) per 4 second feet usually will treat 100 yards of stream.

Fish normally surface within two minutes after treatment is started and may be easily captured. A good feature of cresol is that affected fish usually recover in fresh water within three to five minutes. Fish not captured immediately after they exhibit distress revive rapidly as the treated water is displaced. (See Reference No. 8.)

Selective Toxins

A refinement in recent years in the field of piscicide application has been the development of selective toxins. These are extremely valuable tools for the fishery manager, and it is anticipated that research and field trials presently underway on additional selective toxins will be of great future benefit.

The most intensive work and large scale application of a selective toxin has been the development on the Great Lakes of an effective lamprey larvicide. Hundreds of chemical compounds were screened before an effective nitrophenol compound (TFM) and nitrosalicylanilide synergist (DCN) were selected. This work is well documented and offers the best hope of restoring the lake trout populations in the Great Lakes area. (See Reference No. 16.)

The recent development of another selective toxin is of particular interest in the Pacific northwest, where infestations of squawfish in lakes and reservoirs often present a problem to the fishery manager. This toxicant, which is selective to squawfish, was developed by Dr. Craig MacPhee, assisted by Mr. Richard Ruelle, at the University of Idaho. (Reference No. 23.) The chemical compound was developed as a result of an extensive bio-assay screening program sponsored by the Bureau of Commercial Fisheries, Columbia River Fisheries Program Office.* The compound, termed "Squoxin," is a nonchlorinated hydrocarbon, C 21 H16 O2, referred to as methylene-1'-di-2-

naphthol. The patent for its use has been assigned to the United States Government. The compound acts on the nervous system of the squawfish as a vaso-constrictor, thus preventing efficient use of oxygen and the proper function of the capillaries. It has the following attractive features:

1. It is lethal to squawfish at the low concentration of 0.1 ppm and is not harmful to salmon or trout at this level.
2. It has no effect on aquatic insects or other fish foods, humans or land animals.
3. It is a slow-working but short-lived toxin that becomes ineffective within a few hours.
4. It does not act as a repellent; fish apparently are unaware of or undisturbed by its presence.
5. It is economical and efficient. It is easy to provide metered application of the liquid toxicant. Good water diffusion is obtained.

*See Reference No. 24.

Thanite

The common liquid insecticide sold under the name of "Thanite" is 82 percent isobornyl thiocyanacetate and 18 percent other active terpens. It has been shown to be an effective selective toxin in warm water fishery management. This product is two to three times more sensitive to centrarchids, as bluegill and green sunfish, as well as rainbow trout, than it is to cyprinids and ictalurids, as the golden shiner, channel catfish and black bullheads. Since overpopulation by sunfish as forage species is a common problem, Thanite is an effective tool. It has another advantage in that adult bass and sunfish can be salvaged unharmed if promptly removed to fresh water. The action of Thanite is similar to that of sodium cyanide, but it is not so potentially dangerous to handle as cyanide. The cost of treatment with Thanite is comparable to that with rotenone.

It should be mentioned that the use of isobornyl thiocyanacetate has not been approved by the U.S. Food and Drug Administration for fish population control, and it probably will be confined to experimental fish control work. (Reference No. 5.)

FISH TOXICANTS

A

*Conversion table to determine number of 50-pound bags per 1,000 pounds when rotenone content varies between 5 and 10 %.

All rotenone requirements based on material having a 5 % rotenone content.

Rotenone percentage (indicated on bags)	Number of 50-pound bags required to get the equivalent of 1,000 lbs of 5% rotenone.
5.0%	20.0
5.2%	19.23
5.4%	18.52
5.6%	17.86
5.8%	17.24
6.0%	16.67
6.2%	16.13
6.4%	15.63
6.6%	15.15
6.8%	14.70
7.0%	14.29
7.2%	13.89
7.4%	13.51
7.6%	13.16
7.8%	12.82
8.0%	12.50
8.2%	12.19
8.4%	11.90
8.6%	11.63
8.8%	11.36
9.0%	11.11
9.2%	10.87
9.4%	10.65
9.6%	10.42
9.8%	10.20
10.0%	10.00

Example:

If a biologist desired 17,000 pounds of rotenone and the material on hand was labeled 6.8%, he would get 17 times 14.70 which equals 249.9 or 250 50-pound bags.

*From State of Washington Department of Game Table.

FISH TOXICANTS

References Reviewed

1. Needham, Robert G., "Effects of toxaphene on plankton and aquatic invertebrates in North Dakota lakes." U.S. Bureau of Sports Fisheries and Wildlife, Investigations in Fish Control No. 4 (Resource Publication 8). Washington, D.C. January, 1966.
2. Meyer, Frederick A., "Chemical control of undesirable fishes." In "Inland Fisheries Management," edited by Alex Calhoun, pp. 498-510. California Department of Fish and Game, Sacramento. 1966.
3. Smith, M.W., "Copper sulphate and rotenone as fish poisons." Transactions of the American Fisheries Society, 69:141-157. 1939.
4. Warnick, Donald C., "Growth rates of yellow perch in two North Dakota lakes after population reduction with toxaphene." U.S. Bureau of Sports Fisheries and Wildlife, Investigations in Fish Control No. 5 (Resource Publication 9). Washington, D.C. 1966.
5. Lewis, William M., "Isobornyl thiocyanacetate as a fish drugging agent and selective toxin." The Progressive Fish-Culturist, 30(1):29-31. January, 1968.
6. Willford, Wayne A., "Toxicity of dimethyl sulfoxide (DMSO) to fish." U.S. Bureau of Sports Fisheries and Wildlife, Investigations in Fish Control No. 20 (Resource Publication 37). Washington, D.C. April, 1967.
7. Smith, M.W., "The use of copper sulphate for eradicating the predatory fish population of a lake." Transactions of the American Fisheries Society, 65:101-114. 1935.
8. Wilkins, L. Price, "Observations on the field use of cresol as a stream survey method." The Progressive Fish-Culturist, 17(2):85-86. April, 1955.
9. Bridges, W.R., "Sodium cyanide as a fish poison." U.S. Fish and Wildlife Service, Special Scientific Report-Fisheries, No. 253. 1958.
10. Mulla, Mir S., James St. Amant, and Lauren D. Anderson, "Evaluation of organic pesticides for possible use as fish toxicants." The Progressive Fish-Culturist, 29(1):36-42. January, 1967.
11. Callahan, Mac A., and Melvin T. Huish, "An evaluation of antimycin as a selective bluegill toxicant under varying conditions of pH." Southeastern Association of Game and Fish Commissioners, 21st Annual Conference, Proceedings, pp. 476-481. New Orleans, Louisiana. September 24-27, 1967.
12. Howland, Robert M., "Interaction of antimycin A and rotenone in fish bioassays." The Progressive Fish-Culturist, 31(1):33-34. January, 1969.
13. Walker, Charles R., Robert E. Lennon, and Bernard L. Berger, "Preliminary observations on the toxicity of antimycin A to fish and other aquatic animals." U.S. Bureau of Sports Fisheries and Wildlife, Circular 186. Washington, D.C. June, 1964.
14. Avault, James W., and Gilbert C. Radonski, "Use of antimycin as a fish toxicant with emphasis on removing trash fish from catfish ponds." Southeastern Association of Game and Fish Commissioners, 21st Annual Conference, Proceedings, pp. 472-475. New Orleans, Louisiana. September 24-27, 1967.
15. Marking, Leif L., and James W. Hogan, "Toxicity of Bayer 73 to fish." U.S. Bureau of Sports Fisheries and Wildlife, Investigations in Fish Control No. 19 (Resource Publication 36). Washington, D.C. 1967.
16. Howell, John H., Everett L. King, Jr., Allen J. Smith, and Lee H. Hanson, "Synergism of 5, 2'-dichloro-4'-nitro-salicylanilide and 3-trifluoromethyl-4-nitrophenol in a selective lamprey larvicide." Great lakes Fishery Commission, Technical Report No. 8. Ann Arbor, Michigan. 1964.
17. Phillippy, C.L., "Results of selective shad treatments in six central Florida lakes." Southeastern Association of Game and Fish Commissioners, 18th Annual Conference, pp. 198-205. Clearwater, Florida. October 18-21, 1964.
18. Henegar, Dale E., "Minimum levels of toxaphene as a piscicide in North Dakota lakes." U.S. Bureau of Sports Fisheries and Wildlife, Investigations in Fish Control No. 3 (Resource Publication No. 7). Washington, D.C. January, 1966.
19. Kong, Soong Min, "Shell 'endrex' used as a fish toxicant." The Progressive Fish-Culturist, 22(2):93. April, 1960.
20. Mahdi, Mahmoud Ahmed, "Mortality of some species of fish to toxaphene at three temperatures." U.S. Bureau of Sports Fisheries and Wildlife, Investigations in Fish Control No. 6 (Resource Publication 10). Washington, D.C. January, 1966.
21. St. Amant, James A., William C. Johnson, and Marvin J. Whalls, "Aqualin as a fish toxicant." The Progressive Fish-Culturist, 26(2):84-88. April, 1964.
22. Workman, G.W., and J.M. Neuhold, "Lethal concentrations of toxaphene for goldfish, mosquitofish and rainbow trout, with notes on detoxification." The Progressive Fish-Culturist, 25(1):23-30. January, 1963.
23. MacPhee, Craig, and Richard Ruelle, "A chemical selectively lethal to squawfish (*Ptychocheilus oregonensis* and *P. umpqua*)." Transactions of the American Fisheries Society, 98(4):676-684. October, 1969.
24. MacPhee, Craig, and Richard Ruelle, "Lethal effects of 1888 chemicals upon four species of fish from western North America." University of Idaho, Forest, Wildlife, and Range Experiment Station, Bulletin 3. Moscow, Idaho. November, 1969.

Chapter 18

Avoidance

Effect of stream velocities.

Temperature effects.

Pressure changes as affecting closed and open swim bladder fish.

Light intensity changes.

Sudden noise or movement.

Non-recognition of contaminants.

Avoidance of electric shock.

Low oxygen levels and supersaturated nitrogen.

Fish seek velocities near their cruising speed limit.

Reaction to chemicals.

Avoidance of odors.

References Reviewed.

AVOIDANCE

Basically, avoidance can be defined as a reluctance or refusal of fish to move from one place or situation to another. Avoidance reaction can be immediate or from long-term exposure to a changed condition.

Fish apparently do not recognize danger areas if they are already adapted to conditions as the high velocities that may exist at diversions. If downstream migrants are in high velocities, they may choose to remain there and avoid changing to lower velocities. Conversely, if they are in low velocities they may refuse to enter higher velocities, such as those encountered in ferrying across a stream or screen face. Upstream migrants do not avoid high velocities, although such velocities can result in their being swept into the buckets of dams. (See Chapter 6, "Swimming Speeds of Adult and Juvenile Fish.") Fish may enter areas of high turbulence by darting movement but normally they avoid such areas at sustained swimming levels.

In general, fish may become locked into a situation, whether good or bad.

Fish may avoid high temperatures as they are capable of sensing low temperature differences, but they may remain in temperatures at their upper tolerance level for long periods of time before moving to cooler areas. This could be defined as long-term avoidance. (See Chapter 11, "Temperature - Effects on Fish.") Fish acclimated to high temperatures that are near their upper tolerance may more readily move to even higher temperatures than do fish that are acclimated to temperatures well below this threshold. Conditioning preceding avoidance movement may be an important triggering effect.

Fish may avoid pressure changes. Closed swim bladder (physoclist) fish can become depth-accustomed over a period of time. Open swim bladder (physostome) fish must compensate for depth by gulping air at the surface before descending.

Fish may avoid light intensity changes, both high and low, as they do when seeking shadow areas in fishway passage. (See Chapter 26, "Artificial Guidance of Fish.")

Fish may avoid sudden noise or movement, but ignore the same noise or movement if it continues over a long period of time. Fish are affected by sound waves and the resulting pressure. They appear to be sensitive to changes within the range of 5-1,000 hertz, which is approximately between C_6 and C_8 on the musical scale.

They may enter contaminated areas even if such are danger areas as they apparently do not recognize all contaminants.

They will avoid electric shock but there is no evidence that they have a directional response if trapped in moving water, under which condition they may dart into a field. In still water they may learn to avoid electric stimuli.

Fish do enter areas of low oxygen level, apparently seeking ways through such areas, but generally appear to avoid total areas of low oxygen levels simply because of their inability to survive within. Fish are known not to avoid water with supersaturated nitrogen and may be so trapped and killed. Siltation levels must be high to cause long-term avoidance. (See Chapter 12, "Silt and Turbidity.")

Their general behavioral pattern of movement indicates that they will ultimately seek velocities near their cruising speed limit for movement. They will penetrate silted water. They will generally avoid bright lights. They will adapt to both temperature and depth or pressure situations if not lethal. If held in waters near their upper tolerance level, they ultimately will seek cooler waters. They also may seek cooler waters, if food is in short supply or if conserving body fats is required. They will respond to shadow and light patterns, generally favoring cover. In clear water, downstream migrants usually move in darkness periods, but under turbid conditions they will move in daylight.

Fish react to certain chemicals, although not many have been tested. If possible, they apparently avoid sublethal levels of copper and zinc. They may avoid chlorine as low as 1 milligram per litre but, if locked into a situation where chlorine is present at levels of 0.1 mg/l, they may choose to remain there, although the concentration finally may be lethal. Fish do not avoid all pesticides and herbicides, although salmon and trout react by refusing to enter areas that have 2,4-D in extremely low concentrations.

Fish normally avoid exposure and constriction, although these tendencies are negated when they are required to accept trapping by movement from a larger to a smaller space to gain direct movement. Transition should be provided to avoid abrupt spacial changes.

Fish avoid odors and apparently are able to recognize the representative odor of their home stream. Odors that cause sharp reactions are those of mammalian skin, particularly man, dog and bear in which L-Serine has been identified. A single introduction of L-Serine may cause avoidance of up to 20 minutes. There is good evidence as to the synergistic effects of various combinations of temperature, light and odor; therefore, the most acceptable level known should be provided at all passage facilities.

AVOIDANCE

References Reviewed

1. Brett, J.R., and D. MacKinnon. "Some aspects of olfactory perception in migrating adult coho and spring salmon." Fisheries Research Board of Canada, Journal, 11(3):310-318. May, 1954.
2. U.S. Army Corps of Engineers, North Pacific Division, "Progress report on fisheries - engineering research program," pp. 76-90A. Contributed by U.S. Bureau of Commercial Fisheries, "Research on Fishway Problems." Portland, Oregon. July, 1960.
3. Hansen, David J., "Avoidance of pesticides by untrained sheepshead minnows." Transactions of the American Fisheries Society, 98(3):426-429. July, 1969.
4. Jones, J.R. Ericksen, "The reactions of *Pugosteus pungitius* L. to toxic solutions." Journal of Experimental Biology, 24(1 and 2):110-122. September, 1947.
5. Kleerekoper, Herman, "Olfaction in fishes." Indiana University Press, Bloomington. 1969. (*No part of this book may be reproduced without permission in writing from the publisher.*)
6. Major, Richard L., and James L. Mighell, "Influence of Rocky Reach Dam and the temperature of the Okanogan River on the upstream migration of sockeye salmon." U.S. Fish and Wildlife, Fishery Bulletin, 66(1): 131-147. January, 1967.
7. Höglund, Lars B., "The reactions of fish in concentration gradients: a comparative study based on fluvium experiments with special reference to oxygen, acidity, carbon dioxide, and sulphite waster liquor (SWL)." Fishery Board of Sweden (Drottningholm), Institute of Freshwater Research, Report No. 43. 1961.
8. Canada Department of Fisheries and International Pacific Salmon Fisheries Commission, "A report on the fish facilities and fisheries problems related to the Fraser and Thompson River dams site investigations." Prepared in collaboration with the British Columbia Department of Fisheries and British Columbia Game Commission, Vancouver, B.C. November, 1955.
9. Brett, J.R., and D. MacKinnon. "Some observations on olfactory perception in migrating adult coho and spring salmon." Fisheries Research Board of Canada, Progress Reports of the Pacific Coast Stations, No. 90:21-23. March, 1952.
10. Alderdice, D.F., J.R. Brett, D.R. Idler, and U. Fagerland, "Further observations on olfactory perception in migrating adult coho and spring salmon - properties of the repellent in mammalian skin." Fisheries Research Board of Canada, Progress Reports of the Pacific Coast Stations, No. 98:10-12. April, 1954.
11. Sprague, John B., "Avoidance reaction of salmonid fish to representative pollutants." Water Research, 2(1): 23-24. January, 1968. (*Each issue of this periodical is copyrighted.*)
12. Sprague, J.B., "Avoidance of copper-zinc solutions by young salmon in the laboratory." Water Pollution Control Federation Journal, 36(8):990-1004. August, 1964.
13. Moss, Sanford A., "The responses of young American shad to rapid temperature changes." Transactions of the American Fisheries Society, 99(2):381-384. April, 1970.

Chapter 19

Hatcheries

Need and function of hatcheries.

Fish species propagated.

Temperatures criteria.

Catch-escapement ratio for hatcheries.

Water quality and supply.

Diseases (See Chapter 21).

Silt problem.

Hatchery siting.

Screening of intakes.

Water recirculation and replacement.

Control of egg losses.

Algae control.

Toxic effect of paints and coatings and other commercial material.

Pond planning and design.

Hatchery requirements and design.

Food storage location.

Waste disposal system.

Related buildings.

Lighting.

Man-year required for pounds of fish.

Fish marking techniques.

Suggested planting rates for natural and rehabilitated lakes.

Net Pens

Fish species propagated.

Design, including size.

Considerations in siting.

Bottom fishing a problem.

Bottom fouling.

Water density and fish food.

Examples of loading densities.

Variation in growth rates.

Table 1. Approximate number of temperature units required for egg hatching and swim up for Pacific salmon at 50 F. (1 unit for each °F. above 32 F. for 24 hours).

Table 2. Variability in temperature units for hatching and swim up needed over a time period.

Table 3. Suggested conditions for the storage of Oregon Moist Pellets and Abernathy Dry Feed and food size for various fish sizes.

A. Apparatus for Treatment of Hatchery Water Supply With Malachite Green.

B. Pond Load Factors as Related to Length of Trout and Salmon to Estimate Weight of Fish (Lbs.) Per GPM Inflow.

C. Oregon Pellet Feeding Chart.

D. Oxygen and Growth of Young Coho Salmon.

E. Feeding Rate for Rainbow Trout of Various Sizes at Various Temperatures.

F. Food Consumption at Various Temperatures and Sizes (Using Abernathy Soft Pellet 27.5 Per Cent Protein).

G. Effect of Feeding of Live Minnows to Brook Trout.

H. Food Conversions of Salmonids.

I. Trout: Fish Length Vs. Weight (Fish Per Pound).

J. Daily Pumping Costs.

References Reviewed.

HATCHERIES

Hatcheries have an important place in fishery management and aquaculture. They precede all other early rearing and grow-out rearing of all fish. Under present laws and regulations the construction of new hatcheries, rearing ponds, and net pens requires permits with public comment prior to final planning stages. In recent years, their efficiency has been greatly enhanced by the application of increased knowledge of the biological needs of fish and by improvements in fish cultural methods in the areas of egg hatching facilities, rearing procedures, feeds and nutrition, and disease prevention and control. This increased efficiency has resulted in increased growth and higher survival rates for juveniles, and, therefore, greater adult returns. Planting techniques have not improved proportionately. Research efforts are currently under way to study outplanting and supplementation strategies and their effects on adult returns.

The values of hatcheries lie in several functions: (1) to mitigate fish losses caused by construction of barriers to natural spawning and rearing areas and/or diversion of stream flows for water uses; (2) to maintain and increase overexploited fish stocks (outplanting); (3) to mitigate fish losses caused by pollution or alteration of the natural environment; (4) to stock or rehabilitate habitable areas where fish populations have been eliminated or badly depleted by unfavorable conditions or to utilize new areas not available because of obstructions (supplementation); (5) to enhance production in areas where natural production potential (rearing capacity) is not realized; (6) to introduce species that are suitable to an altered environment, as are warm-water or pan fish to certain reservoir areas; and (7) to produce juvenile fish for food fish aquaculture grow-out.

Hatchery production of Pacific salmon includes all five West Coast species. The best results are obtained with coho and fall chinook salmon. Spring chinook are also successfully propagated in many areas. Some kokanee (landlocked sockeye) eggs also are taken at a few locations for lake reservoir stocking.

Hatchery production of trout is concerned chiefly with indigenous or long-established species, principally steelhead and resident rainbow. Native cutthroat trout are propagated in some areas where they occur naturally. The introduced Eastern brook char is propagated to a limited extent for special stocking requirements, such as high mountain lakes where it is self-sustaining. Only small numbers of brown trout, another introduced species, are reared.

There are many hatcheries for warm-water species whose specific function is to supply game fish. There is a large industry dependent on pond culture for various species. The most recent is the use of heated water effluent in fish cultural work to speed up the hatching and rearing time or to make available large numbers of fish in warm water pond rearing.

Few hatcheries are ideally suited for handling both warm and cold water species and few are suitable for both maintaining a brood stock and rearing salmon. Rainbow trout brood stock will not produce satisfactory eggs around the 49th parallel if the water temperature is constantly over 56 F., whereas salmon and steelhead fingerlings for rapid growth during rearing require water in the upper portion of the optimum temperature range (55 to 60 F.). Around the 49th parallel, incubation temperatures below 42 F. have an

adverse effect on salmon and rainbow trout eggs, causing excessive losses. It is recognized that north of this parallel the optimum requirements decrease and south of this parallel they increase. The change in the optimum temperature range may also be affected by altitude. The amount of water required for egg incubation at locations where heated water can be obtained cheaply makes its heating to optimum range feasible, thereby increasing the efficiency of the hatchery.

Sudden drops or rises in temperature should be avoided during the critical tender stages of egg development (pre-eyed egg).

Warm-water fish, including largemouth bass, sunfish, catfish, and crappie, are not propagated extensively in the Northwest because of their limited use and because it is normally a cold-water environment. However, the popularity of these species as sport fish continues to increase, requiring more efficient artificial propagation.

In contrast to fishery management policies that have required further restrictions on fishing seasons and gear for catch limitations on naturally produced fish, properly planned hatchery operations may permit greater catches. (See References No. 5, 11, 18, 21, 32, and 35.) Continuing studies during recent years indicate an overall benefit-cost ratio between 2 and 3 to 1 for hatcheries. The estimated average catch-escapement ratio for the hatcheries under study was between 3 and 6 to 1. (See References No. 5, 33, and 35.)

For species differences as to timing, fecundity, size and egg size, see Chapter 5, "Useful Factors in the Life History of the Most Common Species" and Chapter 7, "Spawning Criteria."

In site selection for a once-through-flow-system hatchery, the primary requisite is a constant, ample supply of clear, good quality water within the optimum temperature range and free from disease organisms. (See Chapter 11, "Temperature - Effects on Fish.")

The water supply must be adequate to maintain a year-around sustained flow for the hatchery and pond system in accordance with the planned fish production capacity. It must be legally protected from upstream diversions, impoundments, or degradation of water quality. Its source may be rivers or small streams, deep wells, artesian wells or springs, lakes or reservoirs, or a combination of sources, each of which has advantages and peculiar problems. Streams and rivers are subject to fluctuation, which usually carries considerable amounts of debris that require screening at the intake. Silt is also a problem in some streams, and requires a settling basin.

Streams, lakes, and reservoirs support hosts that transmit disease organisms. Deep wells require pumping and frequently carry an excess amount of dissolved gaseous nitrogen that must be dispelled by some means of gas stabilization such as agitation or oxygen injection. Lakes and reservoirs often promote excess algae growth; they also may present temperature problems, depending on the extent of water level fluctuation and the location of the hatchery water intake. A multi-level intake may be required. All intakes from streams and lakes require that small fish be screened out of the water supply. In cold areas the intakes must be protected against freezing or frazil ice.

HATCHERIES

Hatcheries should be located away from flood plains or adequately protected from floods.

Reliable power supplies must be available within reasonable distance for station operation or from a supply on station, and auxiliary generators must be evaluated for the economics of backup power.

The hatchery should be accessible at all seasons, as well as within reasonable distance from schools, stores, and other living requirements of station personnel. Ease of communication is also an essential item. Remoteness of the site may make such amenities impractical.

Water recirculation and reconditioning offer advantages where the amount of water available and the incidence of fish diseases are limiting factors. The cost of recirculating water versus the cost of a once-through system can be compensated for by increased fish production. (See References No. 20 and 86.) Recirculating systems may be used at either hatcheries or rearing ponds, or at both. The water re-use requires a replacement supply of 5 to 10 per cent.

A major problem in a water recirculation system is the gradual buildup of metabolic wastes. In Reference No. 37, it is shown that at stocking rates of less than five pounds of fish per gpm, urea was the principal product, and had no apparent harmful effects; however, above five pounds of fish per gpm, ammonia was dominant, and was toxic to fish when they were continuously exposed to concentrations of the un-ionized form as low as 0.006 ppm. A biological filter system is needed to provide nitrifying bacterial beds for the transformation of ammonia wastes into harmless nitrates. The control of pH can be satisfied by using oyster shells or chemical additives. Oxygen replenishment and carbon dioxide dissipation is accomplished by re-aerating devices in the water reconditioning system which will provide 90 to 100 per cent re-aeration or by oxygen injection. The small amount of replacement water required has several advantages. It makes sterilization easier when using sand filters and ultraviolet radiation. The filters first remove particles larger than 15 microns, including silt, protozoan disease organisms, and parasitic trematode worms. This a necessity to allow for use of ultraviolet radiation, which is effective in destroying disease organisms smaller than 15 microns, including some protozoans, bacteria, and viruses. Water temperature control in a re-use system frequently can be achieved by the amount of replacement water introduced. Another method is to route approximately 10 per cent of the recirculating water or, as needed, through a heat exchanger for cooling or heating. (See Reference No. 20.)

For the control of parasites, disease organisms and bacteria other than by ultraviolet methods, see Chapter 21, "Fish Diseases - Types, Causes and Remedies."

Egg losses in hatcheries have been greatly reduced by the introduction into the water supply of fungus-inhibiting chemicals. One such system is shown on Exhibit A. Such chemicals must be checked for effects on humans.

Topical treatment of affected trout brood stock sometimes is undertaken. Careful handling and avoidance of overcrowding will reduce injuries and abrasions, which serve as an entry point for *Saprolegnia*, a common fungus infection. Some fish culturists prefer to keep brood stocks in earth ponds in order to avoid abrasions from concrete walls.

Excessive growth of algae in hatchery water supplies may clog screens, valves and nozzles and, in extreme cases, hinder fish activity by clogging gills and interfering with respiration. Heavy crops of algae in warm-water ponds may produce oxygen supersaturation in daylight and sufficient oxygen depletion at night to cause fish kills. A method of overcoming this is to increase the number of water changes per hour. Algae grow in great profusion in water courses rich in nutrients. Green algae grow best in water temperatures of 77 to 95 F. but are found at lower temperatures. Blue-green algae, often considered as one indicator of water pollution, grow best in water temperatures of 86 to 104 F. but are found at temperatures below this range.

Copper sulphate is the most widely used chemical for control of microscopic and single-filament algae. It is not effective against branched forms or leafy waterweeds. The effective concentration may be close to the tolerance level for fish, especially salmonids, depending on mineral content of the water and, if used, must be closely regulated. In soft water with a total alkalinity of 50 ppm or less, the maximum dosage of copper sulfate considered safe for fish is 0.25 ppm for a single application. In hard waters where total alkalinity is above 50 ppm, concentrations up to 1 ppm or even higher may be used, depending on the total alkalinity.

Certain commonly sold commercial materials should be avoided in hatchery construction where they would come in contact with the water supply, such as copper, galvanized pipe, cadmium plated screens and fittings, some aluminum and low-numbered stainless steel alloys, and lead (including solder). Bronze fittings and pump impellers should be avoided.

Many paints, particularly rust-preventive types, lacquers, varnish, and some plastics, contain materials that may be toxic. Avoid use of copper and, where possible, phenol-based wood preservative compounds, especially where flushing rates are low.

Creosote, which contains phenol, must be avoided.

Fresh concrete may be somewhat toxic until it has been leached in running water or thoroughly cured.

See Chapter 10, Water Quality, Chapter 13, Toxicities of Elements and Compounds, Chapter 14, "Metals," Chapter 15, "Plastics," and Chapter 16, Pesticides and Herbicides."

Adult salmon and steelhead ponds require special consideration. Large ponds are preferred to avoid overcrowding. Within suitable dissolved oxygen and water temperature ranges, adult holding capacity is based on a maximum of two pounds of fish per cubic foot of water, with a complete water change 1.5 times per hour ($R=1.5$). Where possible, adult holding ponds should be located where there is a good attraction flow to encourage voluntary entrance of spawners. In general, they should be adapted to eliminate unnecessary handling and for convenience in spawning operations.

Frequently ponds are built in tandem as an aid in separating male and female, as well as sexually mature and immature fish. Freeboard up to six feet may be required to prevent adult fish from jumping out of the pond. A portion of the pond surface is sometimes covered to provide shade as an aid in keeping the fish quiet and in reducing sunburn. Some holding ponds are made with sloping side walls to

HATCHERIES

discourage jumping. In ponds with a surface inflow through a rack or screen at the upper end, a considerable amount of crowding, jumping and fighting at the intake structure may occur, with consequent injury to fish and eggs. This can be eliminated by providing an upwelling type of water inflow from the bottom of the pond. Jumping can be partially controlled by providing a means of disturbing the water surface to produce cover with a water sprinkler system.

Trout brood stock ponds usually do not differ greatly from the type generally used for rearing, except that they may be larger and deeper. As the fish are held for indefinite periods, the trout brood stock pond usually is operated considerably below its maximum capacity under ideal conditions of oxygen and water temperature. Some fish culturists prefer partially shaded earth ponds for this purpose to simulate natural conditions and prevent unnecessary disturbance and possible injury to the fish. All ponds should be provided with complete drainage facilities. In sockeye holding ponds, the upwelling method is the only one that is acceptable. See Chapter 20, "Rearing Ponds," for currently used sizes and loading capacities versus water supplies.

The main hatchery building is used primarily for egg incubation and initial feeding of fry, and includes storage and laboratory space. The building should be located near the ponds and other station operations. A conventional salmon hatchery would have some combination of deep troughs and shallow troughs and some tray and box incubators. Some modern hatcheries are using incubators sized to accept eggs from one to four females. These incubators are placed in tandem with individual water intake gate valves.

In salmon hatcheries the newly fertilized eggs are water-hardened, measured and placed immediately in hatching containers. Depending on the type of hatching container (basket, tray, barrel or box), individual egg capacities vary from 30,000 to 50,000 per basket, from 8,000 to 10,000 per tray, and from 250,000 to 500,000 plus in a barrel or box. The capacity of these containers depends on the following: egg size (see Chapter 5, "Useful Factors in Life History of Most Common Species," Table 1), availability of oxygen (see Chapter 35, "Oxygen") and needs of individual species. When trays are used for chum fry, bio-rings or flexi-saddles are recommended.

It has been found that hatchery fry at swim-up time are generally smaller than fry emerging from natural spawning grounds. Fish culturists have developed various methods to increase the fry size, which lessens growth time and, consequently, improves survival rate.

After fertilization (24 to 48 hours), the eggs become tender and should not be handled until they reach the eyed stage, which usually occurs in two to three weeks, depending on temperature, or within approximately one-third of the total incubation period. When the eggs are eyed, they usually are shocked by syphon action, the infertile eggs are removed, and the others placed on trays and stacked. As the embryo develops, the oxygen requirement increases. See Chapter 35, "Oxygen." In five or six weeks after hatching, the yolk-sac fry or alevins absorb all of the yolk material, swim actively toward the surface and start feeding. Salmon and trout fry may be transferred to ponds or feeding tanks as soon as they reach the feeding stage.

Aisle space between the equipment used for hatching varies with the size of the incubators or troughs. If tray

incubators are used, the space must allow for a tray to be removed and handled.

Many trout hatcheries and some salmon hatcheries use shallow troughs to incubate up to 50,000 steelhead eggs per basket, 6 baskets per trough, and to feed up to 25,000 or 50 pounds of fry at a water inflow of 10 gpm. Care must be taken that baskets and screens are not clogged with egg shells at the time of hatching. Steelhead fry usually are transferred to rearing ponds when they reach a size of about 100 fish per pound.

Another common cabinet incubator is the NOPAD incubator. Its dimensions are 4' wide x 4' long x 1' deep, and it can be stacked up to five trays high. The incubator trays are made of aluminum and are loaded with eggs or alevin while in place, and must be lifted by fork lift or crane when full. This incubator is somewhere between a true cabinet type incubator and deep matrix type incubators in terms of capacity. The incubator capacity ranges from 150,000 to 200,000 eggs and 75,000 to 100,000 alevins per tray.

The amount of food fed daily to various species of salmon and trout is based on a percentage of body weight, taking into consideration the type of food, the size of fish and the water temperature. (See Exhibit E.)

In newer hatchery design, vertical tray incubator cabinets have replaced troughs, and there is a current trend to replace a part of the cabinets with barrels (R-48) or deep matrix boxes. Incubator cabinets reduce the amount of water required for incubation but, more important, they require only about one-half the amount of floor space as troughs, with a proportionate reduction for the barrels or boxes. A typical small 8-tray incubator cabinet measures approximately 2 feet square and 2-1/2 feet high. Larger trays, 4x4x1 feet, are described as the NOPAD incubators. Two or more cabinets may be stacked vertically. The frames may be made of aluminum, and the trays of aluminum or fiberglass reinforced polyester resin. The eggs remain in the trays until the normal swim-up and the start of the feeding stage.

This type of hatchery is in use where IHN virus is a serious problem. The arrangement permits the destruction of eggs in incubators where IHNV is found. Additional space or limited loading of eggs and fry are both means of reducing the infection of IHNV.

Eggs from individuals or from up to four females may be hatched as a unit. If IHN is suspected, hatching barrels or boxes may be used which may contain an egg hatchery basket from which newly hatched fry enter the box or barrel. If IHN is found, the water may be stopped and the eggs or fry killed.

In order to prevent the spread of disease in a hatchery, no splash should be allowed.

Frequently, eyed eggs are transferred from one hatchery to another. This may occur when one station has surplus eggs. It is much easier and more economical to transport eyed eggs than small fish. Some stations may have cooler water that is better adapted to egg incubation. The optimum temperature range for salmon egg incubation is 45 to 55 F. at latitudes 49 to 50. Other stations may have warmer water better adapted to the rapid rearing of fingerlings. Temperatures of 55 to 60 F. at latitudes 49 to 50 are desirable for salmon rearing. This is also an important consideration in the hatching and rearing of

HATCHERIES

trout. These factors must be weighed against the possibility of straying, if fish are transferred among stations to lessen the growing time.

To prevent possible disease transmission, eggs should be disinfected before being transferred to another hatchery and usually are certified disease-free by qualified pathologists.

Provision should be made in hatchery design for various labor-saving devices. These include such items as automatic fish grading and sorting equipment for use in ponds, automatic fish feeding equipment, bin loaders and fish food conveyors, adequate driveways between ponds, self-cleaning screens, fish pumps or other mechanized fish loading equipment, and convenient fish weighing facilities. Where possible, fish transferring due to life stage and rearing space requirements should be done by gravity flow.

An adequate cold room for storage of fish food must be provided at a convenient location on the station. Its capacity depends on the extent of the rearing program, but generally a minimal capacity of 60,000 pounds is desirable. This is because food deliveries, for reasons of economy, usually are made in 40,000-pound lots. Dry foods should be stored at a low humidity, and dehumidification equipment now is included in plans for such storage areas. Since the advent of improved pellet foods, extensive and fast-freezing facilities are not required. Large food preparation rooms, with food cutting, grinding, and mixing equipment, no longer are necessary. A recent concept for large installations, and used extensively in commercial food fish aquaculture, is the construction of bulk fish food storage areas, using one-ton bins and bin loaders. This takes less space and is more economical than storing food in 50-pound sacks.

Recent studies of effluent discharges from several hatcheries conducted by the Federal Water Quality Administration indicate that, in order to comply with applicable water quality standards developed by EPA, some waste treatment must be adopted. Some remedial measures may be required at existing hatcheries, and water treatment facilities should be included in designs for new hatcheries. Coordination with the appropriate state and federal agencies should be followed during planning and retrofitting of hatcheries.

If IHN is present, all the hatchery effluent must be sterilized. Chlorine may be used to accomplish this. Ultraviolet or O_3 may also be used.

The problem of water pollution from hatchery discharge lessens if a hatchery uses a water reconditioning and re-use system, which results in a lesser outflow. Partial treatment also is afforded by biological filters and ultraviolet sterilization; however, the discharge of filter backwash and skimming water one or more times daily may create some problems. An adequate hatchery waste disposal system should provide filtration and aeration facilities, sedimentation by means of a settling basin, and means of disposing of solid wastes. Two-hour holding should be considered. Chemical treatment of waste water also may be required, with chlorine, ozone or ultraviolet light exposure for control of certain diseases. The single pass flow-through type of pond system, using much larger flows, presents greater problems in designing pollution control equipment and vacuum pond cleaning techniques should be practiced to reduce the quantity of flow of the polluted water.

Shop and garage buildings are required, usually combined, where station automotive and other equipment can be maintained. Automotive equipment should include one or more pickup type trucks for hauling equipment and supplies, and should be capable of carrying a small portable fish distribution tank. At least one of the trucks should be a four-wheel drive.

The number and size of fish distribution units depend on the pounds of fish to be delivered. Often larger units are planned to serve the needs of several hatcheries in a region. See Chapter 30, "Transportation - Mechanical Hauling of Fish."

A separate small fireproof building should be provided for storage of paint and volatile or highly flammable liquids.

Adequate fire protection should be provided for all buildings, with fire hydrants and hoses at convenient locations.

Satisfactory family housing, as well as bachelor quarters, should be provided for permanent members of the hatchery staff. It is advantageous to have a minimum number of employees living on the station in the event of emergencies and as a precaution against theft and vandalism. Seasonal workers must be provided quarters as well.

Other items of consideration in hatchery design include the water pipelines, gradients for gravity flows, intakes and discharge structures. Adequate valves must be provided at the intake and throughout the hatchery and pond system so that the water can be controlled and distributed as desired. Trash racks and self-cleaning screens may be necessary on the water intake structure, and winter icing conditions must be considered. Alarm systems should be installed to give positive warning in case of either power or water supply failure. Diesel-powered electric generators should be available on a stand-by basis in the event of a major power supply outage, particularly where pumping is required.

Eggs and fry must be protected against direct sunlight. Hatchery rooms should remain in darkness when not being serviced by personnel. Filament lighting is recommended over fluorescent lighting. General illumination should be held at a level to make possible safety and movement. Direct working lights should be provided for servicing troughs and cabinets.

Civil Service and other labor requirements may dictate the number of people at a station. The general policy is to maintain as few permanent personnel as possible, augmenting this force by temporary help during the fish-handling season.

For comparative purposes, one man-year is required for each 20,000 to 25,000 pounds of fish produced.

There are many means of marking and tagging fish to measure recovery. Some of the methods that have been developed in recent years are described below.

For later identification, tetracycline may be included in the diet of young fish to cause a deposit to form in the bony tissues which becomes a fluorescent gold color when illuminated by ultraviolet light.

Cold-branding of young salmon and steelhead has been used successfully for short-term marking (about six weeks),

HATCHERIES

with some brands remaining visible for a much longer period. The branding tool is cooled in a mixture of acetone and dry ice at minus 78 C. Liquid nitrogen may also be used as a cooling agent.

Various tattooing and metal dart inserting instruments have been developed and radioactive isotopes have been used experimentally.

One of the chief objections to most fish marking techniques is that they allow little or no identification of the individual fish. Where this is needed, some form of serially numbered tag is required for later reading. Sonic tags transmit signals which enable the fishery biologist to chart the location and movement of individual fish. Sonic tags are expensive. Although their size has been reduced, they are still difficult to insert, causing difficulty for use with large numbers.

Numbered tags in widespread use are made of monel metal and are similar to cattle ear tags. These usually are attached to the gill cover or the base of the caudal fin. Various modifications of paired metal and plastic disc and button type tags, first used in Europe, have also been used successfully here. These often are attached by means of a rustproof wire through the base of the dorsal fin rays or through the gill cover.

Other less commonly used tags are the plastic spaghetti and silk streamer types. Internal metal and plastic tags have been used on some marine species by means of a small incision into the body cavity.

Tattooing by fluorescent dye is used for short-term marking. Fish also may be identified for short periods by spraying techniques.

Fish handled for tagging frequently are anesthetized. See Chapter 22, "Use of Anesthetics and Tranquilizer Drugs in Fisheries Work."

A tag that has had widespread, successful use is the coded wire tag inserted in the snouts of fingerlings or smolts.

Also available are tags known as PIT tags which are implanted internally in juvenile fish and are recognized electronically again at the adult stage or during outmigration. The electronic reader can read the code on the PIT tag without sacrificing the fish.

Elevation affects the availability of oxygen. This is shown in the table on Exhibit B and in Chapter 35, "Oxygen."

As an aid in determining the changing requirements of fish because of size and temperature, see Exhibit C.

The effect of oxygen on weight gain, food consumption and food conversion is shown on Exhibit D. It is evident, around the 49th parallel, that as the temperature reaches 40 F., the ability of the fish to assimilate food is materially reduced. This is shown on Exhibits E, F and G and is also covered in reference No. 39. This suggests that feeding might be reduced to once a week when the temperature is at 40 F. or below. High temperatures increase the metabolic rate, as shown on the exhibits. It is also indicated that salmonoid fish reduce their feeding when temperatures are above 62 F.

The caloric content of various foods and their conversion is shown on Exhibit H.

As an aid in determining fish per pound related to inches of weight of fish in grams or ounces, refer to Exhibit I.

A method of computing pumping costs developed by the Washington Department of Fisheries is shown on Exhibit J.

In clear lakes or ponds, rates for stocking hatchery fry vary with the size of the fish and turbidity levels. Three hundred to 500 small fingerlings per acre may be planted. Not over 150 per acre is recommended in the 2- to 3-inch range. Approximately 260 per acre is recommended in the 3- to 4-inch range, 200 per acre at the 5- to 6-inch range, and 140 per acre at the 8- to 10-inch range. In rehabilitated lakes the stocking rate may be increased to 500 to 700 pounds of small fingerlings per acre.

To help in determining size factors, included are tables and exhibits.

Net Pens

Many species of fish, both cold water and warm water, are currently being successfully hatched and grown by commercial aquaculture in the United States. The methods and techniques of husbandry developed through the years are very similar to, and are founded on, those practiced by government-funded enhancement hatcheries and rearing stations. In the United States the most commonly raised species are the Pacific and Atlantic salmon, steelhead, rainbow trout, tuna, striped bass and, to a lesser extent, some marine cod and flatfish. Elsewhere in the world, many other species, such as tilapia and carp, are cultured.

The contribution of aquaculture in the overall harvest of food fish has grown substantially in recent years and is forecast to continue. Husbandry methods have changed rapidly. Hatcheries remain mostly fresh water and land-based; however, rearing, or the growing-out stage of various species, has been extended from land-based rearing facilities to both land- and water-based facilities. A typical production station utilizes a land-based, fresh water hatchery with a water-based rearing facility. The need for water-based facilities has partly arisen from limited land space. The water-based facilities can be fresh water or marine facilities. The most common water-based station is the marine net pen complex.

Hatched fish, such as pink salmon or others, if reared in fresh water, may be transferred as juveniles to marine net pens for grow-out. The transfer from fresh water to saline water can only be done successfully when the fish are at a stage where they will accept salt water.

The marine net pens may be supported by any of a variety of predesigned floating structures constructed of steel, concrete, wood, aluminum, or high-density polyethylene plastic. The floating structures provide support for the nets, walkways, and feeding and harvesting apparatus. The mesh size of the nets must be properly selected for retention of fish of the size to be handled and for maximum water circulation. Both body width and depth are a percentage of the length of the fish. See Chapter 5, "Useful Factors in Life History of Most Common Species." Fouling from marine organisms and predator control must also be considered. Various materials for netting are utilized, with the most common being a synthetic material, such as nylon or

HATCHERIES

polyester coated with an antifouling compound. When the fish handled will at any point in their life stage be used for food, careful selection must be made of an antifouling coating which has been approved by the Food and Drug Administration.

The most common size of net pens is approximately 40 x 40 x 20 feet (length x width x depth) but they vary widely. The complexes free float and must be anchored. Many types of anchors are in use, fabricated from steel, iron, concrete or piles. Such anchoring must secure the pens from damage from expected storms at a specific site.

Bottom fouling is a common problem with net pen culture. Fish waste and the accumulation of uneaten food cause a gradual buildup of sediment that has a very high biological oxygen demand (BOD) and therefore becomes a water pollutant. This can become anaerobic and produce odors as an air pollutant. The siting of a net pen complex must consider these waste products.

In siting a net pen complex, the following should be considered: exposure to weather, distance from a market or planting site or terminal harvest area, sources of fresh and salt water, a continuing and guaranteed source of juveniles, and water quality factors as temperature, turbidity, oxygen, etc.

In marine net pen systems adequate water interchange must occur, usually from tidal currents, to supply the required dissolved oxygen. See Chapter 1, page 11 (nomenclature). Consideration of tidal currents during the neap tide phases must be a priority in siting, and an effort must be made to eliminate the effect of nontidal movement. Algae accumulation causes problems of net fouling, and floating algae and diatoms can cause severe stress to the fish within the nets.

Pelleted fish feed formulations must be modified to match the density of salt water (specific gravity) for a proper sinking rate. Water densities at any given site may be affected by a change in water temperature and by the dilution of salt water by fresh water. Both vary seasonally and can work synergistically to the detriment of the feeding area of the pen.

Fish in marine net pens are subjected to many diseases, the treatment for which is more difficult than in fresh-water ponds because of the inability to confine them in a controlled water vessel. The disease treatment, therefore, constantly varies in concentration and is difficult to standardize and therefore must be applied through the food.

In some cases the net pens are provided with skirts or partial impervious outer coverings to allow for salinity changes by introducing fresh water. The loading densities (pounds of fish per cubic foot) in net pens must be site specific and therefore can vary widely. Densities also vary with species. Examples of loading densities are: chinook salmon from 0.4 to 0.5, steelhead trout from 0.25 to 0.5, Atlantic salmon from 0.75 to 2.5, and chum salmon at 0.5.

Salt water loading densities are not greatly different from those in fresh water rearing ponds. This becomes a useful check. See Chapter 20, "Rearing Ponds."

The State of Washington is establishing a maximum density area relationship for areas outside net pens, which approximates 0.027 lb/sq ft based on 1,000,000 lb/nautical square mile.

Growth rates vary, as they are affected by site specific conditions, and generally approximate the growth experienced wholly in fresh water at similar temperatures. Salt water temperatures, being more stable the year around, extend the growing season.

HATCHERIES

Table 1

Approximate Number of Temperature Units Required for Egg Hatching and Swim up for Pacific Salmon at 50 F. (1 Unit for Each 1 F. Above 32 F. for 24 Hrs.)

	Units to hatching	Units to swim up
Chinook	900	1,700
Coho	850	1,500
Sockeye	1,350	1,900
Chum	950	1,200
Pink	1,100	1,800

A rule may be applied that hatching uses 2/3 of the day degrees needed for swim up.

Table 2

Variability in Heat Needed Over a Time Period is Shown by the Following Tables.

Water Temperature	Temperature of Units to Hatching	Units to Swim Up
Pink salmon		
40 F.	1,003	1,520
42 F.	1,115	1,690
44 F.	1,172	1,776
48 F.	1,309	1,984
54 F.	1,467	2,222
Sockeye		
34 F.	450	225 Days 682
36 F.	734	1,112
38 F.	942	1,428
40 F.		
42 F.	1,115	1,690
44 F.		
46 F.	1,201	1,820
48 F.		
50 F.	1,254	70 Days 1,908
52 F.		
54 F.	1,365	2,068
56 F.	1,441	2,184
58 F.	1,523	2,308
60 F.	1,626	2,464

(See Reference No. 41).

Table 3

Suggested conditions for the storage of Oregon Moist Pellets and Abernathy Dry Feed and food size for various fish sizes.

	Oregon Moist Pellets	Abernathy Dry Feed
Long term storage conditions	Keep frozen at 5-10° F.	Equip storage area with a dehydrator to keep food dry
Short term storage conditions	Refrigerate after opening food sack	Hold in dry area after opening food sack
Feeding conditions	Feed to fish when water temperature is below 45° F.	Feed to fish when water temperature is above 45° F.

Fish size/ ration size (For both Oregon Moist pellets and Abernathy Dry Feed)

Fish Size	Feed Size in inches
1200-1000 fish/lb	Starting mash

(Note: Mix 1/32 pellets with starting mash initially; by the time fish are at 900-800 fish/lb feed 1/32 pellet only)

1000-500 fish/lb	1/32 pellet
500-250 fish/lb	3/64 pellet
250-150 fish/lb	1/16 pellet
150-50 fish/lb	3/32 pellet
50-15 fish/lb	1/8 pellet
15 and above fish/lb	3/16 pellet

Contact manufacturers for specific storage requirements.

HATCHERIES

A

Apparatus for Treatment of Hatchery Water Supply

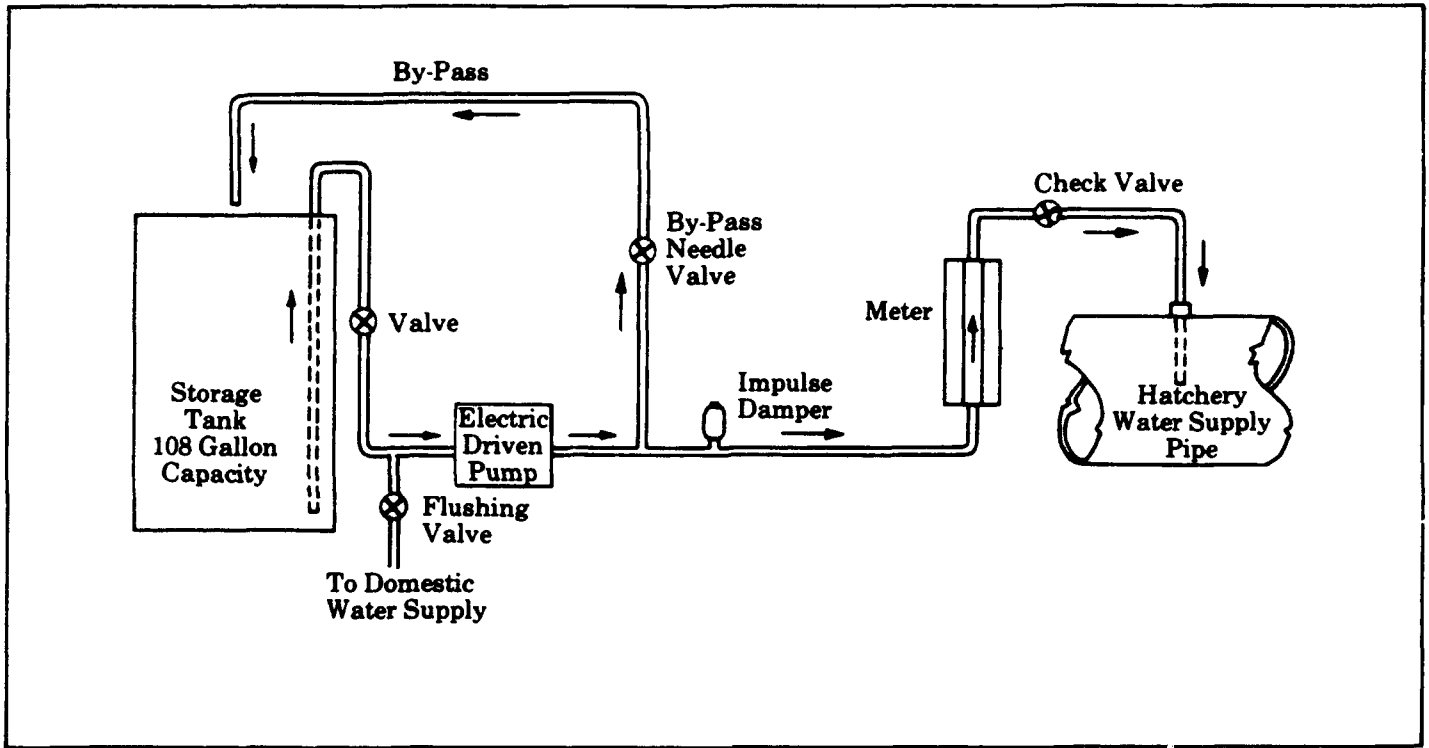

WWFC Conference Procedure. Springfield, Oregon, 1986 or Tumwater, 1987.

HATCHERIES

B

Pond Load Factors As Related to Length of Trout and Salmon
To Estimate Weight of Fish (Lbs.) Per GPM Inflow

Feet Above Mean Sea Level	Water Temperatures (F.)																		
	45	46	47	48	49	50	51	52	53	54	55	56	57	58	59	60	61	62	63
0	2.24	2.18	2.11	2.05	1.98	1.92	1.86	1.79	1.73	1.66	1.60	1.54	1.48	1.40	1.36	1.33	1.29	1.25	1.21
1,000	2.18	2.11	2.05	1.98	1.92	1.86	1.79	1.73	1.66	1.60	1.54	1.48	1.40	1.36	1.33	1.29	1.25	1.21	1.18
2,000	2.11	2.05	1.98	1.92	1.86	1.79	1.73	1.66	1.60	1.54	1.48	1.40	1.36	1.33	1.29	1.25	1.21	1.18	1.14
3,000	2.05	1.98	1.92	1.86	1.79	1.73	1.66	1.60	1.54	1.48	1.40	1.36	1.33	1.29	1.25	1.21	1.18	1.14	1.11
4,000	1.98	1.92	1.86	1.79	1.73	1.66	1.60	1.54	1.48	1.40	1.36	1.33	1.29	1.25	1.21	1.18	1.14	1.11	1.08
5,000	1.92	1.86	1.79	1.73	1.66	1.60	1.54	1.48	1.40	1.36	1.33	1.29	1.25	1.21	1.18	1.14	1.11	1.08	1.06
6,000	1.86	1.79	1.73	1.66	1.60	1.54	1.48	1.40	1.36	1.33	1.29	1.25	1.21	1.18	1.14	1.11	1.08	1.06	1.03
7,000	1.79	1.73	1.66	1.60	1.54	1.48	1.40	1.36	1.33	1.29	1.25	1.21	1.18	1.14	1.11	1.08	1.06	1.03	1.00
8,000	1.73	1.66	1.60	1.54	1.48	1.40	1.36	1.33	1.29	1.25	1.21	1.18	1.14	1.11	1.08	1.06	1.03	1.00	
9,000	1.66	1.60	1.54	1.48	1.40	1.36	1.33	1.29	1.25	1.21	1.18	1.14	1.11	1.08	1.06	1.03	1.00		
10,000	1.60	1.54	1.48	1.40	1.36	1.33	1.29	1.25	1.21	1.18	1.14	1.11	1.08	1.06	1.03	1.00			

F x L = W

F = Load Factor

L = Length of fish in inches

W = Weight in pounds per GPM inflow

Example: 50 F., 5,000' MSL, 4" (40 per lb.) = 1.6 x 4 = 6.4 lbs. fish per GPM inflow.

Based on data from fish loading experiments at Bozeman Fish Cultural Department Center, Montana.

Prepared by Bruce B. Cannady, April 23, 1969

Ref. USFWS Hatchery Manager Manual

HATCHERIES

C

Oregon Pellet Feeding Chart

(For Salmon and Steelhead, Includes Recommended Feeding Level and Feeding Frequency)

Feeding level (L) expressed as percentage of lot weight to be fed per feeding day.

Feeding frequency (F) expressed as number of days to feed per week and number of feedings per day.

Example: 7/4 means feed 7 days per week, 4 times per day; E/1 means feed every other day, 1 feeding per day.

Ave. H ₂ O temp. (F)	800-300		300-200		200-135		Fish size (number per pound)						40-25		25-larger		
	L	F	L	F	L	F	L	F	L	F	L	F	L	F	L	F	
35	2.7	7/5	2.3	7/4	1.8	7/2	1.6	6/1	1.3	5/1	1.4	E/1					
6	2.8	"	2.4	"	1.9	"	1.8	"	1.4	"	1.4	"					
7	2.9	"	2.5	"	2.0	"	1.9	"	1.5	"	1.6	"					
8	3.0	"	2.6	"	2.1	"	2.0	"	1.7	"	1.8	"					
9	3.2	"	2.7	"	2.2	"	2.1	"	1.8	"	1.8	"					
40	3.4	"	2.8	"	2.3	"	1.9	7/1	1.6	6/1	1.3	5/1					
1	3.6	"	2.9	"	2.4	"	2.0	"	1.8	"	1.3	"	1.4	E/1	1.0	E/1	
2	3.8	"	3.0	"	2.5	"	2.1	"	1.9	"	1.4	"	1.4	"	1.0	"	
3	4.0	"	3.1	"	2.6	"	2.2	"	2.0	"	1.5	"	1.6	"	1.2	"	
4	4.2	"	3.3	"	2.7	"	2.3	"	2.1	"	1.7	"	1.8	"	1.2	"	
45	4.4	"	3.5	"	2.8	"	2.4	"	2.2	"	1.8	"	1.8	"	1.4	"	
6	4.6	"	3.7	"	2.9	"	2.5	"	2.3	"	2.0	"	2.0	"	1.4	"	
7	4.8	"	3.9	"	3.0	"	2.6	"	2.5	"	2.1	"	2.2	"	1.6	"	
8	5.0	"	4.1	"	3.2	"	2.7	"	2.6	"	2.2	"	2.4	"	1.6	"	
9	5.3	"	4.3	"	3.4	"	2.8	"	2.7	"	2.4	"	2.4	"	1.8	"	
50	5.6	"	4.5	"	3.6	"	2.9	"	2.8	"	2.1	6/1	1.8	5/1	1.8	"	
1	5.9	"	4.7	"	3.8	"	3.0	"	2.9	"	2.2	"	2.0	"	2.0	"	
2	6.2	"	4.9	"	4.0	"	3.2	"	3.0	"	2.3	"	2.1	"	2.2	"	
3	6.5	"	5.1	"	4.2	"	3.4	"	3.2	"	2.5	"	2.2	"	2.4	"	
4	6.8	"	5.4	"	4.4	"	3.6	"	3.3	"	2.6	"	2.4	"	2.6	"	
55	7.1	"	5.7	"	4.6	"	3.8	"	3.5	"	2.7	"	2.5	"	2.8	"	
6	7.5	"	6.0	"	4.8	"	4.0	"	3.7	"	2.8	"	2.7	"	3.0	"	
7	7.9	"	6.3	"	5.0	"	4.2	"	4.0	"	2.9	"	2.8	"	3.2	"	
8	8.3	"	6.6	"	5.3	"	4.4	"	4.2	"	3.0	"	2.9	"	3.4	"	
9	8.7	"	6.9	"	5.6	"	4.6	"	4.4	"	3.2	"	3.1	"	3.6	"	
60	9.1	"	7.2	"	5.9	"	4.8	"	4.7	"	3.6	"	3.2	"	3.8	"	

RECOMMENDED PELLET SIZE

Fish Size (number per pound)

Pellet Size (inches)

800-500

1/32

500-250

3/64

250-150

1/16

150-50

3/32

50-larger

1/18

Other trout are fed at 1% body weight, varying with temperature.

February 1968

HATCHERIES

D

Oxygen and Growth of Young Coho Salmon

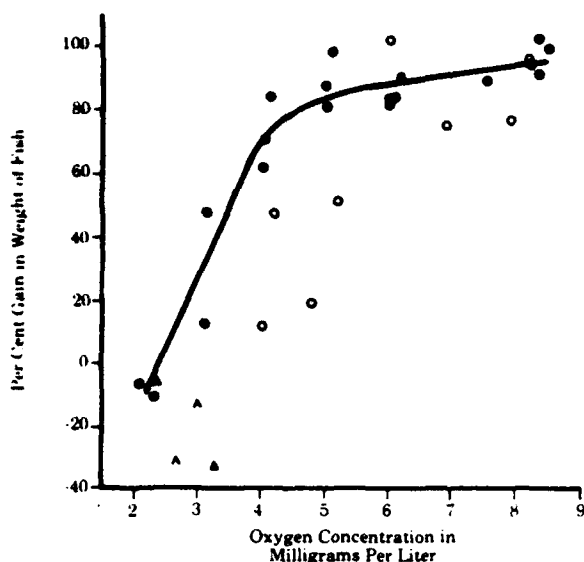

Figure 1. Weight gains (or losses) in 19 to 28 days among frequently fed age-class 0 coho salmon, expressed as percentages of the initial weight of the fish, in relation to dissolved oxygen concentration. The curve has been fitted to the points representing results of tests performed in the year 1956 only. All of the 1956 positive weight gain values are results of 21-day tests.

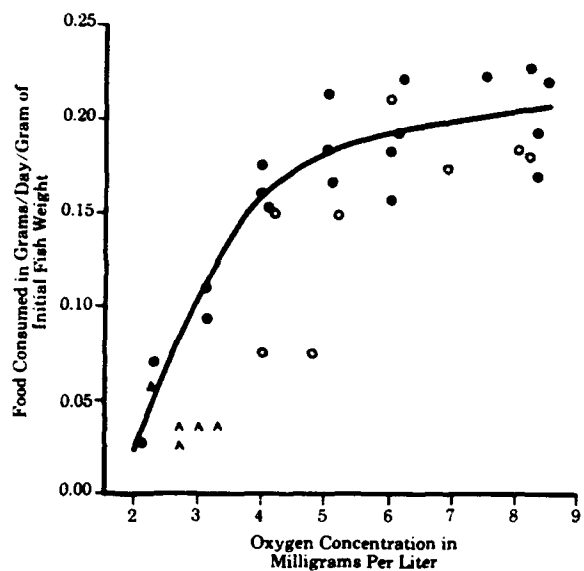

Figure 2. Grams of food (beach hoppers) consumed by frequently fed age-class 0 coho salmon per day per gram of initial weight of the fish, in relation to dissolved oxygen concentration. The curve has been fitted to the points representing the 1956 data only.

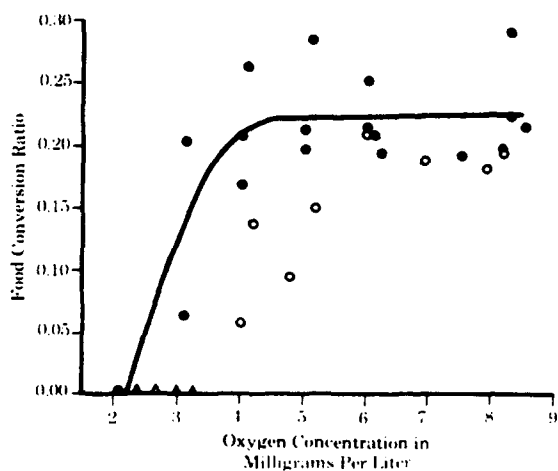

Figure 3. Food conversion ratios for frequently fed age-class 0 coho salmon, or their weight gains in grams per gram of food (beach hoppers) consumed, in relation to dissolved oxygen concentration. A food conversion ratio of zero (not a ratio having a negative value) has been assigned to each group of fish that lost weight. The curve has been fitted to the points representing the 1956 data only.

- ▲ 1956 Tests
- ▲ 1955 Tests
- Only or Mostly Surviving Fish
- ▲▲ Only or Mostly Dying Fish

Saturation Values at 20° C

2 = 22%	5 = 56%	8 = 90%
3 = 33%	6 = 68%	9 = 103%
4 = 45%	7 = 79%	

Adapted from Reference No. 34 of Chapter 8, "Food Producing Areas."

HATCHERIES

E

Feeding Rate for Rainbow Trout of Various Sizes At Various Temperatures

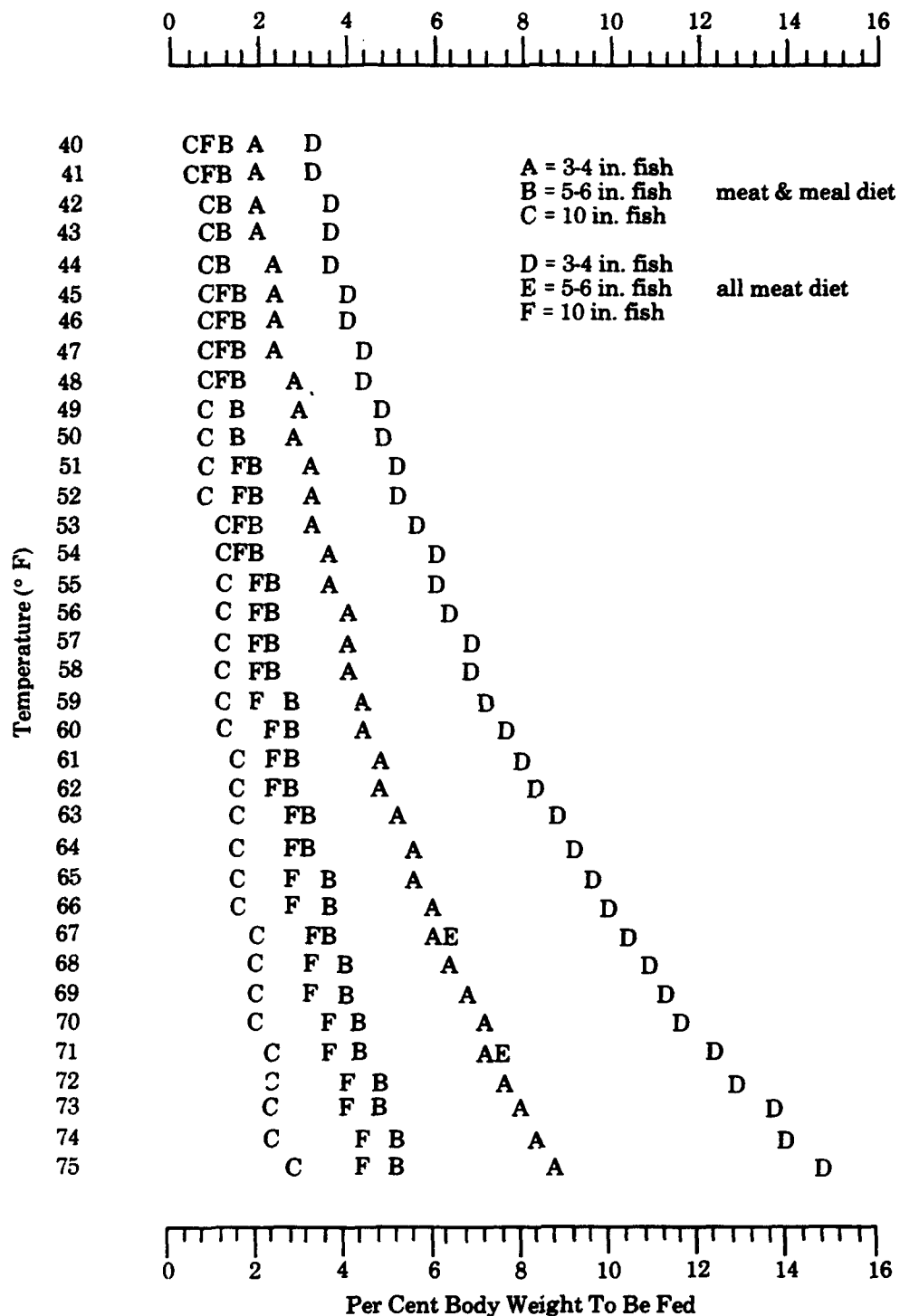

N.B. Values from 61° to 75° are extrapolated from the experimental data.
Energy values must account for changes in tissue water content up to 20 per cent.

Prepared by Don M. Fagot - data from Reference no. 25

HATCHERIES

F

Food Consumption at Various Temperatures and Sizes (Using Abernathy Soft Pellet 27.5 Per Cent Protein)

	Temperature (°F)	Per Cent Body Weight Per Day in Food Fed	Per Cent Drop in Food Fed Between Fingerlings & Adults
1.33 inches to 2.00 inches	40	3.0	--
	45	3.8	--
	50	4.8	--
	55	6.1	--
	60	7.6	--
	Adults	40	0.8
45		1.0	62.0
50		1.5	68.0
55		1.9	68.0
60		2.4	68.5

Comparison of Abernathy Soft Pellet With Two Other Types of Food

Type of Food	Per Cent Protein (wet weight)	Per Cent Body Weight Gain Per Day
Abernathy soft pellet	27.5	5.4
Dry pellet	40	4.5
Meat diet	18	7.4

Prepared from data supplied by Roger E. Burrows

G

Effect of Feeding of Live Minnows to Brook Trout

	48.2° F	Average Temperature 55.4° F	62.6° F
Weight fed per day (grams)	5.02	6.95	5.57
Weight gain per day (grams)	1.42	1.92	1.44
Per cent weight gain per day	1.46	1.99	1.49
Per cent body weight fed per day	5.19	7.2	5.75
Conversion ratio	3.61	3.64	3.90

When temperatures reached 62.6° F, feeding decreased. At temperatures above 69.8° F, the fish only ate 0.85 per cent body weight per day.

Average weight 96.7 grams.

Adapted from Reference no. 40.

H

Food Conversions of Salmonids

Ratio, Weight Fed to Weight Gained	Type of Food	Per cent Protein Wet Weight	K per lb. Food*
1.74:1	Abernathy test diet: 16.32% salmon meal 15.63% dried skim milk 10.42% cottonseed meal 7.81% wheat germ 9.61% soybean oil 2.00% vitamin mix 38.21% water	25	1070
2.7:1	Brine shrimp	11.8	336
2.9:1	50% meat and 50% meal	27.6	725
2.9:1	100% meat	18.3	415
4.9:1	Natural foods	11.5	280
6.05:1	Gammarus (amphipods)	--	--

K = 1000 calories

Prepared from data supplied by Roger E. Burrows

HATCHERIES

I Fish Lengths vs Weight (Fish/Lb.)

Trout - Average Length in (mm)

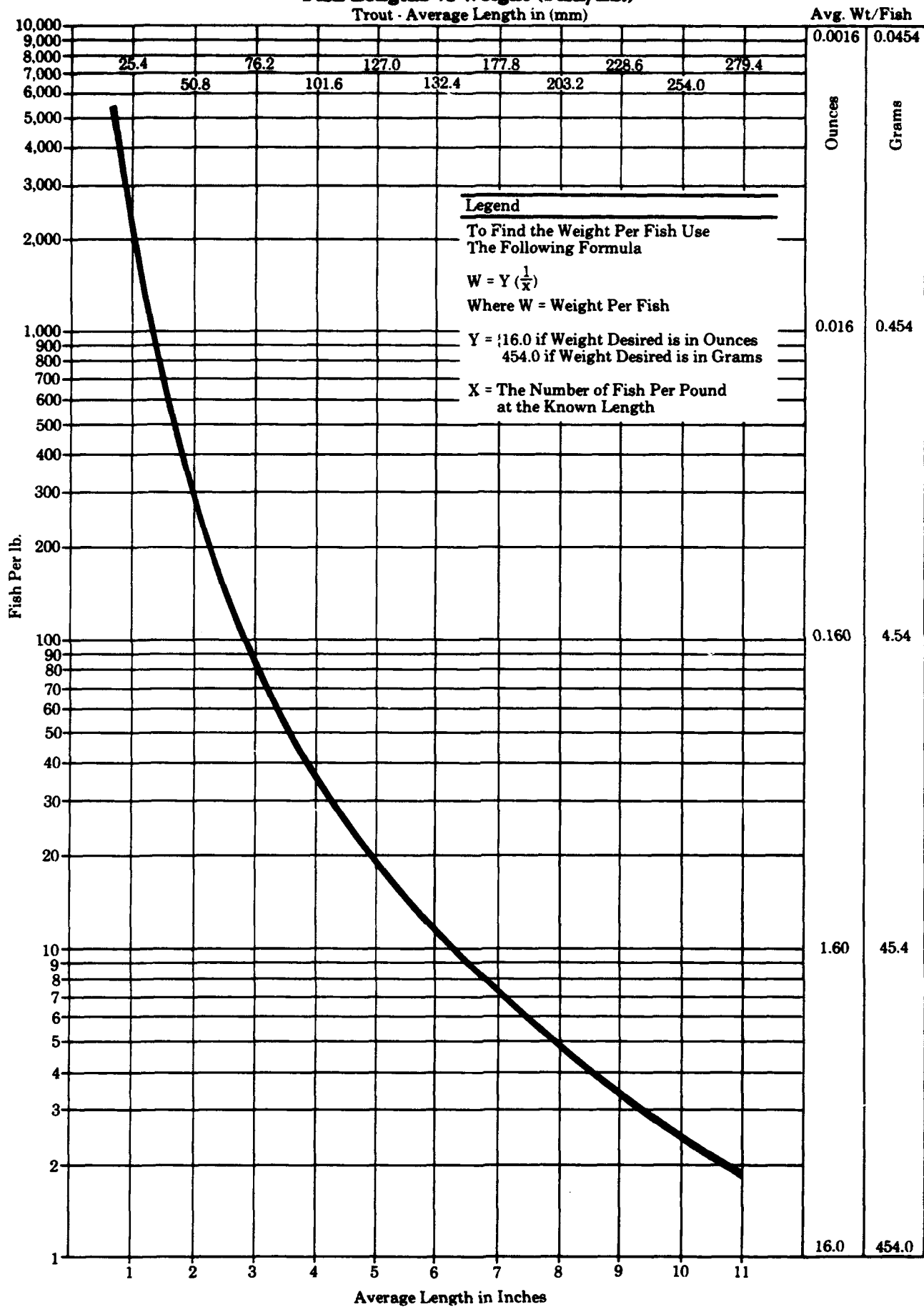

HATCHERIES

J Daily Pumping Costs

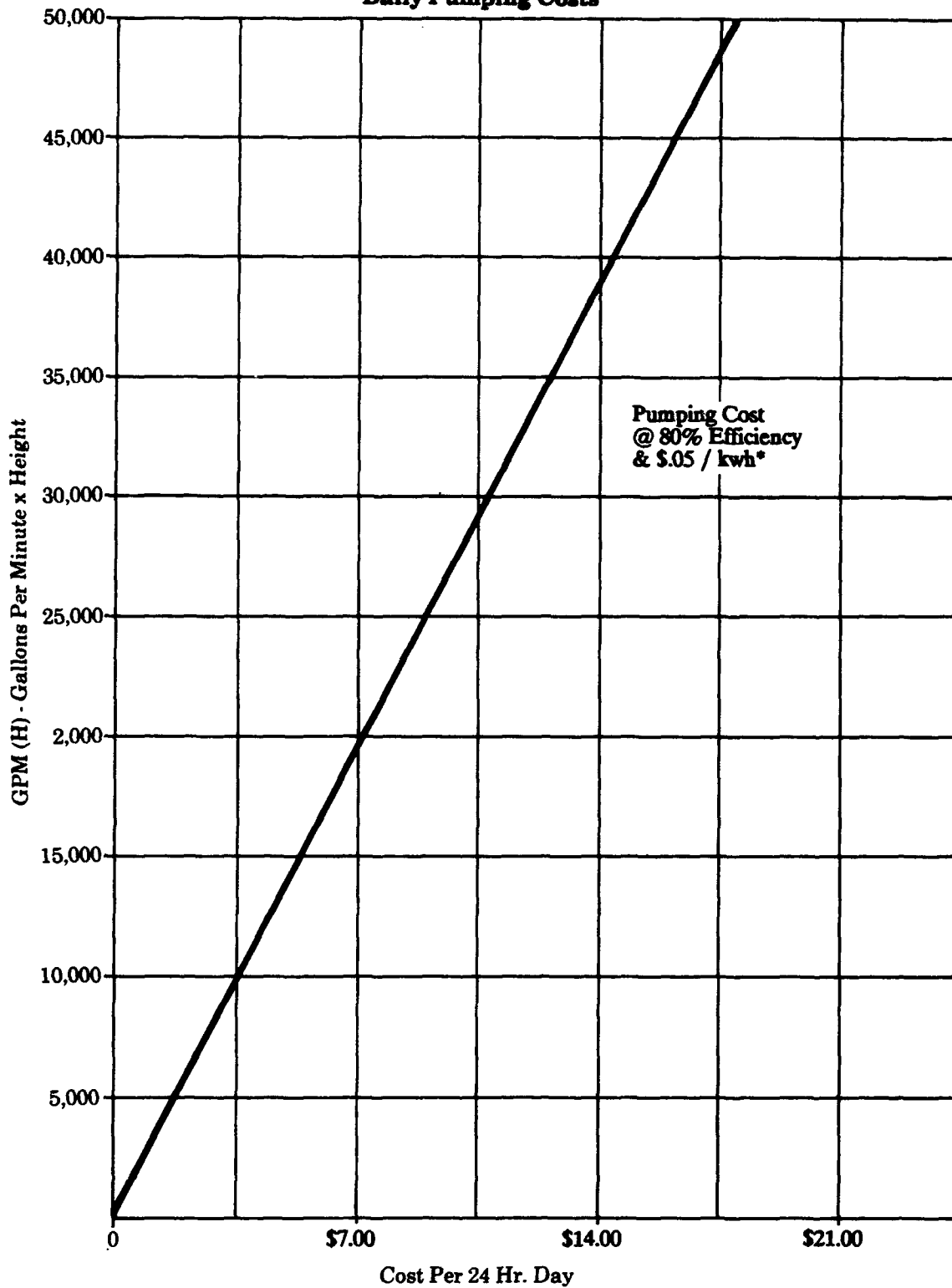

*Other rates would be proportional to the 5 cent base.

HATCHERIES

References Reviewed

1. Brannon, E.L., "The influence of physical factors on the development and weight of sockeye salmon embryos and alevins." International Pacific Salmon Fisheries Commission, Progress Report No. 12. New Westminster, B.C. 1965.
2. Haskell, David C., "Trout growth in hatcheries." New York Fish and Game Journal, 6(2):204-237. July, 1959.
3. Carey and Kramer, and Johnson and Anderson, Consulting Engineers, "A comprehensive plan for the anadromous fish hatchery program for the State of Michigan - Volume 1, general considerations and site selections." Prepared for Michigan State Department of Conservation, Lansing. January, 1968.
4. Johnson, Harlan E., and Richard F. Brice, "Use of impounded water for fish cultures." U.S. Fish and Wildlife, Research Report No. 35, pp. 1-35. 1953.
5. Cleaver, Fred, "Recent advances in artificial culture of salmon and steelhead trout of the Columbia River." U.S. Fish and Wildlife Service, Fishery Leaflet No. 623. March, 1969.
6. Washington State Department of Fisheries, "Salmon hatcheries." Olympia. 1969.
7. Junge, Charles O., Jr., and Lloyd A. Phinney, "Study of factors influencing the return of fall chinook salmon (*Oncorhynchus tshawytscha*) to Spring Creek hatchery." Unpublished final report to U.S. Bureau of Commercial Fisheries, Contract No. 14-17-008-124. Fisheries Research Institute, University of Washington, Seattle. June, 1960.
8. Leitritz, Earl, "Trout and salmon culture (hatchery methods)." California Department of Fish and Game, Fish Bulletin No. 107. Sacramento. Reprint, January, 1960.
9. Ellis, C.H., and R.E. Noble, "Barging and hauling experiments with fall chinook salmon on the Klickitat River to test effects on survivals." Washington State Department of Fisheries, Annual Report, 70:57-71. 1960.
10. Mason, John W., Oscar M. Brynildson, and Paul E. Degurse, "Comparative survival of wild and domestic strains of brook trout in streams." Transactions of the American Fisheries Society, 96(3):313-319. July, 1967.
11. Ellis, C.H., and R.E. Noble, "Calculated minimum contributions of Washington's hatchery releases to the catch of salmon on the Pacific Coast and costs assessable to hatchery operations." Washington Department of Fisheries, Fisheries Research Papers 2(2):88-99. April, 1959.
12. Pearson, Lincoln S., Kelly R. Conover, and James B. Haas, "An evaluation of adult coho salmon transplants into Willamette River tributaries." Oregon Fish Commission, Research Briefs, 13(1):25-38. Portland, June, 1967.
13. Hublou, Wallace F., Joe Wallis, Thomas B. McKee, Duncan K. Law, Russell O. Sinnhuber, and T.C. Yu, "Development of the Oregon pellet diet." Oregon Fish Commission, Research Briefs, 7(1):28-56. July, 1959.
14. Washington Department of Fisheries, "Cowlitz hatchery functional design—a report." Olympia. November, 1965.
15. Elliott, Joseph W., "The oxygen requirements of chinook salmon." The Progressive Fish-Culturist, 31(2): 67-73. April, 1969.
16. Washington Department of Fisheries, "Bacterial contamination associated with the planting of fingerling salmon." Unpublished memorandum by B.J. Earp to Milo C. Bell. February, 1955.
17. Hublou, Wallace F., "Oregon pellets." The Progressive Fish-Culturist, 25(4):175-180. October, 1963.
18. Senn, Harry G., and R.E. Noble, "A hatchery contribution of coho salmon (*Oncorhynchus kisutch*)." Washington Department of Fisheries, Olympia. April, 1966.
19. Kramer, Chin, and Mayo, Consulting Engineers, "A study of the pollutional effects of salmonid hatcheries." Prepared for the Wisconsin Department of Natural Resources, New York Department of Conservation and Michigan Department of Natural Resources. Seattle, Washington. June, 1969.
20. Burrows, Roger E., and Bobby D. Combs, "Controlled environments for salmon propagation." The Progressive Fish-Culturist, 30(3):123-136. July, 1968.
21. "Washington trout hatchery - one of the most successful operations of its kind." The American Fish Farmer, 1(2):13-16. January, 1970.
22. Eisler, Ronald, "Some effects of visible light on hatching mortality, and early growth of salmonoids." M.S. thesis, University of Washington, Seattle. 1957.
23. Cleaver, Fred C., "The effects of ocean fishing upon the Columbia River hatchery stocks of fall chinook salmon." Ph.D. thesis, University of Washington, Seattle. 1967.
24. Salo, Ernest Olavi, "Silver salmon, *Oncorhynchus kisutch*, survival studies at Minter Creek, Washington." Ph.D. thesis, University of Washington, Seattle. 1955.
25. Deuel, Charles R., and others, "The New York State fish hatchery feeding chart." New York State Conservation Department, Fisheries Research Bulletin No. 3, revised edition. Albany. 1952.
26. Merriman, Daniel, "The effect of temperature on the development of the eggs and larvae of the cut-throat trout (*Salmo clarkii clarkii* Richardson)." M.S. thesis, University of Washington, Seattle. 1934.

HATCHERIES

References Reviewed (Continued)

27. Donaldson, John Russell, "Experimental studies on the survival of the early stages of chinook salmon after varying exposures to upper lethal temperatures." M.S. thesis, University of Washington, Seattle, 1955.
28. Seymour, Allyn Henry, "Effects of temperature upon young chinook salmon." Ph.D. thesis, University of Washington, Seattle. 1956.
29. Orsi, James J., "Dissolved oxygen requirements of fish and invertebrates..". In California Department of Fish and Game and the Department of Water Resources, "Delta fish and wildlife protection study," Report No. 6, Chapter IV, pp. 48-68. June, 1967.
30. Westers, Harry, "Carrying capacity of salmonid hatcheries." *The Progressive Fish-Culturist*, 32(1):43-46. January, 1970.
31. Combs, Bobby D., Roger E. Burrows, and Richard G. Bigej, "The effect of controlled light on the maturation of adult blueback salmon." *The Progressive Fish-Culturist*, 21(2):63-69. April, 1959.
32. Senn, Harry G., and R.E. Noble, "Contribution of coho salmon (*Oncorhynchus kisutch*) from a Columbia River watershed hatchery." Washington State Department of Fisheries, Fisheries Research papers, 3(1):51-62. August, 1968.
33. "Data report: Columbia River coho salmon hatchery contribution study: 1968 sampling season." U.S. Bureau of Commercial Fisheries, Seattle Biological Laboratory, Biometrics Institute, Seattle. April, 1970.
34. Mead, R.W., W.L. Woodall, "Comparison of sockeye salmon fry produced by hatcheries, artificial channels and natural spawning areas." International Pacific Salmon Fisheries Commission, Progress Report No. 20. New Westminster, B.C. 1968.
35. Worlund, Donald D., Roy J. Wahle, and Paul D. Zimmer, "Contribution of Columbia River hatcheries to harvest of fall chinook salmon (*Oncorhynchus tshawytscha*)." U.S. Fish and Wildlife Service, Fishery Bulletin, 67(2):361-391. April, 1969.
36. Foerster, R.E., and W.E. Ricker, "The effect of reduction of predaceous fish on survival of young sockeye salmon at Cultus Lake." Fisheries Research Board of Canada, Journal, 5(4):315-336. 1941.
37. Burrows, Roger E., "Effects of accumulated excretory products on hatchery-reared salmonids." U.S. Bureau of Sports Fisheries and Wildlife, Research Report No. 66. Washington, D.C. 1964.
38. Bodien, Danforth, G., "An evaluation of salmonid hatchery wastes." U.S. Federal Water Quality Administration, Northwest Region. Portland, Oregon. October, 1970.
39. Brett, J.R., and D.A. Higgs, "Effect of temperature on the rate of gastric digestion in fingerling sockeye salmon, *Oncorhynchus nerka*." Fisheries Research Board of Canada, Journal, 27(10):1767-1779. October, 1970.
40. Baldwin, N.S., "Food consumption and growth of brook trout at different temperatures." *Transactions of the American Fisheries Society*, 86:323-328. 1956.
41. Simon, R.C., "Chromosome morphology and species evolution in the five North American Species of Pacific salmon (*Oncorhynchus*)." *Journal of Morphology*, 112(1):77-97. 1963.
42. Fowler, Laurie G., and Roger E. Burrows, "The Abernathy salmon diet." *The Progressive Fish-Culturist*, 33(2):67-75. April, 1971.
43. National Research Council. Subcommittee on Fish Nutrition. "Nutrient requirements of trout, salmon, and catfish." Nutrient requirements of domestic animals, No. 11. National Academy of Sciences, Washington. 1973.
44. Science Applications International Corporation, "Recommended interim guidelines for the management of salmon net-pen culture in Puget Sound." Final report prepared for Washington Department of Ecology in conjunction with the Departments of Fisheries, Agriculture and Natural Resources. Ecology Contract No. C-0087110. Bellevue, Washington. December, 1986.
45. Disler, N.N., "Development of autumn chum salmon in the Amur river." Translated from Russian. Office of Technical Services, U.S. Department of Commerce, Washington, D.C. 1963.
46. Smirnov, A.I., "The effect of mechanical agitation on developing eggs of the pink salmon *Oncorhynchus gorbuscha* (Walbaum). Salmonidae." Translated by R.E. Foerster. Fisheries Research Board of Canada, Translation Series No. 231. Nanaimo, B.C. 1959.
47. Fagerlund, U.H.M., et al, "Stress-related effects of hatchery rearing density on coho salmon." *Transactions of the American Fisheries Society*, 110:644-649. 1981.
48. Senn, Harry, John Mack and Lloyd Rothfus, "Compendium of low-cost Pacific salmon and steelhead trout production facilities and practices in the Pacific Northwest." For U.S. Department of Energy, Bonneville Power Administration, Portland, Oregon. September, 1984.
49. Haddon, Paul, "Engineering Aspects of Pen Farming Finfish in Marine Waters." Master of Science in Engineering thesis. University of Washington, Seattle. 1987.

Chapter 20

Rearing Ponds

Pond construction features.

Pond loading criteria.

Various pond types.

Temperature effects.

Effluent.

Pond limiting factors.

Conversion factors for ppm/lb./gpm
to mg/kg./hr. to O₂/lb./hr.

Table 1. Rearing Ponds.

Table 2. Metabolic Rates of Fish.

**Table 3. Carrying Capacities of
Ponds in Lbs. Per GPM.**

**Table 4. Maximum Loading
Densities.**

**Table 5. Oxygen Consumption of
Fingerling Chinook in Four Ponds
(52 F.) After Pond Cleaning and
Feeding.**

**Table 6. Oxygen Consumption
Measured at Time Intervals After
Handling at 50 F.**

A. Rearing Area.

**B. Potential Composition of Effluent
From Rearing Ponds.**

References Reviewed.

REARING PONDS

Until recently, rearing ponds were considered a part of hatchery operations. They may now be built and operated as separate units, although they generally are dependent on hatcheries as a source of fish. Improved fish food and improved feeding techniques, such as automatic or power feeders, have allowed rearing ponds to become independent units.

Fish held in rearing ponds may depend entirely on natural food supplies or in part or wholly on prepared foods. (See Chapter 19, "Hatcheries," and Chapter 8, "Food Producing Areas," for amounts of food required.)

The fish reared in such ponds are not subjected to many of the natural hazards, including predation by other species; however, they are subjected to unnatural crowding and cannibalism and careful grading for size is required to control the latter.

In general, ponds should be constructed so that they may be drained rapidly and the fish collected at a central point, such as a "kettle." Fish are collected for purposes of grading, treatment for disease, or planting. The ponds are drained for cleaning and disinfecting. Cleaning can be accomplished by suction or by temporarily increased velocities.

Pond loadings are related to size and weight of the fish per unit of surface area, volume or flow. Loadings are based in part to meet oxygen requirements and to provide living space.

The chapter "Hatcheries" contains a table showing the required reduction in poundage of fish due to the elevation above sea level at which ponds are operated. Oxygen saturation is reduced as elevation increases although the requirements of the fish remain the same.

The table on page 20.2 gives the relationship of various types of ponds and the relationship of depth, flow, volume, area and pounds or numbers of fish as now used. Pounds of fish reared show a similarity among the various types of ponds when equated to the above factors. Large, natural rearing ponds follow more closely the levels of highly productive lakes.

As temperature is a governing factor in growth, water quality and quantity of rearing ponds require special attention. If closed-circuit supply systems are used, they should provide for cooling, filtration, sterilization, degasification, reoxygenation and pH control. The residue from rearing ponds has a high BOD and, perhaps, an offensive odor, and the effect of this on the receiving waters should be considered. Preferably it should be handled as a separate waste item apart from normal drains. See Exhibit B.

Exhibit A is a schematic sketch for a natural rearing pond.

As small rearing ponds vary in shape from raceway to rectangular to circular, with all variations between, the principal design criteria should provide a reasonably uniform distribution of flow to assure better distribution of food and improved growth. High velocities should be avoided because of weight loss that results from excessive swimming. (See Chapter 6, "Swimming Speeds of Adult and Juvenile Fish.")

The drainage system must be large enough so that when ponds are built in batteries, dewatering activities will not

interfere with the normal discharges from other ponds.

In accordance with work done by Haskell (1955), the carrying capacities of ponds at any given temperature are directly related to the length of fish contained therein. For example, a pond will carry three times the weight of a 6-inch fish than that of a 2-inch fish.

An increase or decrease in the total weight of fish in a pond for a new loading may be determined by the following formula:

$$\left(\frac{L_n}{L_e} \right) W_e = W_n$$

where L_n and W_n are new length and weight.

L_e and W_e are existing length and weight.

As noted, the metabolic rate is a major factor in determining the total weight of fish in a pond. Fish at a stage of rapid growth require more space room per pound than fish that have reached a stage of decreased feeding requirements.

Various investigators have examined the oxygen demand of fish in rearing, feeding, and holding ponds. Designers may find that to choose a basis for the design of rearing and feeding ponds, they must consider the effects of non-uniform oxygen demands caused by the fish's activity level changes that occur as a result of daylight, darkness, feeding or pond cleaning, compared with the demand at minimum activity.

The experimental work discloses that large fish do not recover as rapidly as small fish from levels of high oxygen use. The laboratory work has also shown that more pounds of fish might be reared per pond than is permitted under hatchery operations. The work shows that there is an upper loading limit. Loading is usually expressed as pounds of fish per cubic foot of pond space. There also is an upper limit under different conditions (temperature level and fish size) to the number of pounds of fish that should be supported per gallon of inflowing water.

Other limiting factors are efficient operating sizes and limiting velocities in the tanks and ponds.

It is apparent that when fish are introduced into ponds they should be given an adequate time to recover, perhaps with additional oxygen to be supplied by additional flow. Stress of handling and transportation, which require a greater oxygen demand for recovery to a normal state, may account for some of the variation in survival of planted fish.

The start of feeding may require a number of small feeding tanks so that the efficiency of growth to food supply can be monitored and the food supply regulated. Low feeding densities of 1/2 pound of fish per cubic foot at this point have been found to be beneficial.

The transfer of fish between tanks and ponds can be accomplished by hose if sufficient drop exists between them.

For ease in converting units, the following can be applied:

$$\text{ppm/lb fish/gpm} = 500.6 \text{ mg O}_2/\text{kg fish/hr}$$

$$\text{Oz O}_2/\text{lb fish/hr} = 1.6 \times 10^{-5} \text{ mg O}_2/\text{kg fish/hr}$$

$$\text{lb fish/gpm} = 0.25 \text{ lbs fish/ft}^3 \text{ water}$$

REARING PONDS

Table 1
Rearing Ponds

Type	Size	Normal Water Depth	Water Requirement	Water Changes Per Hour	Water Re-Use	Add'l Water Required	Fish Capacity	Surface Area (Sq. Ft.)	Volume (Cubic Feet)	Pounds Fish per Sq. Foot	Pounds Fish per Cu. Foot	Pounds Fish per GPM at Intake
Burrows Recirculating	75' x 17' 4 ft deep	2.5 ft	720 GPM or 5776 cu ft/hr	1.1	684 GPM	36 GPM	3780 lbs @ 90/lb; 4725 lbs @ 50/lb	1275	5100	3.7 lbs @ 50/lb	0.93 lbs per ft ³ @ 50/lb	6.5 lbs/ min. @ 50/lb
Raceway (F.W.S.)	80' x 8' 4 ft deep	2.0 ft	400 GPM or 3208 cu ft/hr	1.3	No	No	2000 lbs @ 100/lb; 3200 lbs @ 10/lb	640	2560	3.13 lbs @ 100/lb	0.78 lbs per ft ³ @ 100/lb	5 lbs/ min. @ 100/lb
Raceway (California Fish & Game)	100' x 10' 4 ft deep (sloping edges) 39,270 gal. capacity	3.0 ft	625 GPM or 5013 cu ft/hr	1.7	No	No	3000 lbs @ 100/lb; 3200 lbs @ 10/lb	1000	3000	3.0 lbs @ 100/lb	1.0 lb per ft ³ @ 100/lb	4.8 lbs/ min. @ 100/lb
Raceway (Washington Game)	100' x 10' 4 ft deep	2.5 ft	450 GPM or 3600 cu ft/hr	1.44	No	No	3000 lbs @ 10/lb	1000	2500	3.0 lbs @ 10/lb	1.2 lbs per ft ³ @ 10/lb	6.6 lbs/ min. @ 10/lb
Circular (California Fish & Game)	14 ft dia.	2.5 ft	50 GPM or 401 cu ft/hr	1.0	No	No	400 lbs @ 100/lb	153.86	384.65	2.6 lbs @ 100/lb	1.04 lbs per ft ³ @ 100/lb	8.0 lbs/ min @ 100/lb
Circular (Washington Game)	40 ft dia.	2.5 ft	200 GPM or 1604 cu ft/hr	0.5	No	No	2000 lbs @ 10/lb	1256	3140	1.6 lbs @ 10/lb	0.64 lbs per ft ³ @ 10/lb	10.0 lbs/ min. @ 10/lb
Holding Pond, Beaver Creek (Washington Game)	120' x 12'	5.0 ft	5386 GPM or 43,196 cu ft/hr	0.6	No	No	16,000 lbs @ 10/lb (Steelhead)	1440	7200	11.11 lbs @ 10/lb	2.2 lbs per ft ³ @ 10/lb	3.0 lbs/ min. @ 10/lb
Raceway (Dirt-Wood Wall) South Tacoma	80' x 10'	1-1/2 --2 ft	1346 GPM or 10,795 cu ft/hr	9.0	No	No	400 lbs @ 10/lb	800	1200- 1600	5.0 lbs @ 10/lb	3.33-2.5 lbs per ft ³ @ 10/lb	3.0 lbs/ min. @ 10/lb
Rearing Lake (Natural) Cowlitz Hatchery (Washington Game)	1450' x 175'; 5 acres	4' sloping to 10 ft Ave. 7 ft	4488 GPM (normal); 35,994 cu ft/hr	0.02	No	No	50,000 lbs @ 6/lb	253,750	1,776,250	0.2 lbs @ 6/lb	0.03 lbs per ft ³ @ 6/lb	11.1 lbs/ min. @ 6/lb
Adult Holding Pond (Skamania)	200' x 12'	5.0 ft	8976 GPM	0.07	--	--	30,000 lbs Steelhead	2400	12,000	12.5 lbs	2.5 lbs per ft ³ adults	3.3 lbs/ min. for adults

REARING PONDS

Tables 2-6 demonstrate the above-mentioned relationships of metabolic rates, carrying capacities, maximum loading densities, oxygen consumption after pond cleaning and feeding and effects on oxygen consumption by handling.

Table 2
Metabolic Rates of Fish

Temp. ° F	Standard metabolic (ppm/lb fish /gpm)	Intermediate Metabolic Rates			Maximum ration	Feeding
		Minimum ration	Low main- tenance ration	High main- tenance ration		
39	.080		.104	.196		.613
40	.082		.106	.200		.617
41	.084		.108	.204		.621
42	.086		.112	.208		.625
43	.088		.116	.212		.629
44	.090		.120	.216		.633
45	.092		.124	.220		.637
46	.094		.128	.226		.643
47	.096		.132	.232		.649
48	.098	.114	.134	.238		.655
49	.100	.116	.138	.242		.659
50	.102	.120	.142	.248	.431	.665
51	.104	.124	.144	.254	.439	.671
52	.106	.128	.148	.260	.447	.677
53	.108	.132	.150	.266	.455	.683
54	.112	.138	.152	.276	.465	.693
55	.118	.144	.156	.288	.475	.705
56	.124	.150	.160	.300	.485	.717
57	.132	.158	.166	.310	.497	.727
58	.140	.166	.172	.320	.507	.737
59	.148	.174	.178	.332	.519	.749
60	.156	.182	.184	.342	.531	.759
61	.164	.190	.192	.354	.547	.771
62	.174	.200	.200	.366	.565	.783
63	.184	.210	.208	.382	.581	.799
64	.194	.220	.216	.400	.599	.817
65	.204	.232	.224	.416	.617	.833
66	.218	.242	.232	.431	.637	.848
67	.234	.254	.248	.447	.665	.862
68	.248	.266	.266	.465		.882

Based upon data in this table, the following formulae will apply in calculating oxygen use rates:

Linear Regression

$x = \text{temperature (F.)}$

$y = \log O_2 \text{ consumption (ppm/lb fish/gpm)}$

Standard metabolism

$y = -1.790 + 0.017 x$

Intermediate metabolism minimum

$y = -1.883 + 0.019 x$

Low maintenance feedings

$y = -1.499 + 0.013 x$

High maintenance (same as 1975 night levels)

$y = -1.243 + 0.013 x$

Maximum ration (Brett 1970)

$y = -.896 + 0.010 x$

Feeding Data from Brett and Zala (1975 adjusted to Brett's 1970 curves)

$y = -.438 + 0.005 x$

REARING PONDS

Table 3
Carrying Capacities of Ponds
in Lbs. Per GPM

(Laboratory-determined from
standard metabolic rates)

Chinook salmon			
Temperature (°F)	Mean size (1.85 g)	Mean size (5.90 g)	Mean size (17.50 g)
42°	28.33	30.00	37.71
44°	21.38	24.80	31.80
46°	17.88	20.34	26.22
48°	14.36	17.23	22.40
50°	12.33	14.13	18.93
52°	10.64	12.20	15.62
54°	9.06	10.91	13.71
56°	7.63	9.18	11.84
58°	6.72	8.00	10.00
60°	5.80	7.02	9.09
62°	5.14	6.23	8.00

Adapted from Reference No.4.

Table 4
Maximum Loading Densities

Fish size (grams)	Lb/fish/ ft ³ water	Fish size (grams)	Lb/fish/ ft ³ water
1	.78	20	1.33
2	.82	25	1.43
3	.89	30	1.55
4	.94	35	1.67
5	1.0	40	1.78
10	1.11	45	1.89
15	1.20	50	2.00

Holding of adults is generally on the basis of a maximum of 2 lbs per cubic foot.

See Reference No. 13.

Piper (1970) suggests loading densities as follows: a rule of thumb which might be used to avoid undue fish crowding is to avoid holding trout at more than one-half their length in pounds per foot³ H₂O (i.e., 4" fish should not be stocked at densities greater than 2 lbs/ft³).

See Reference No. 14.

Table 5
Oxygen Consumption of Fingerling Chinook in Four Ponds (52 F.)
After Pond Cleaning and Feeding

Time after cleaning	Time after cleaning	Mean oxygen consumption		High oxygen consumption	
		Mg O ₂ / kg fish/ hr	Oz O ₂ / lb fish/ hr	Mg O ₂ / kg fish/ hr	Oz O ₂ / lb fish/ hr
0.75 hr	0 (start)	324	52 x 10 ⁻⁴	506	81 x 10 ⁻⁴
1.5 hr	0.75	335	54 x 10 ⁻⁴	400	64 x 10 ⁻⁴
2 hr	1.25	193	31 x 10 ⁻⁴	205	33 x 10 ⁻⁴

Adapted from Reference No. 4

REARING PONDS

Table 6
Oxygen Consumption Measured at
Time Intervals After Handling at 50 F.

(15 minutes)		
Fish Size	Mg O ₂ /kg fish/hr	Oz O ₂ /lb fish/hr
5 inch (24 g)	360	58 x 10 ⁻⁴
6 inch (43.6 g)	375	60 x 10 ⁻⁴
7 inch (78 g)		
(30 minutes)		
Fish Size	Mg O ₂ /kg fish/hr	Oz O ₂ /lb fish/hr
5 inch (24 g)	280	45 x 10 ⁻⁴
6 inch (43.6 g)	350	56 x 10 ⁻⁴
7 inch (78 g)	390	63 x 10 ⁻⁴
(45 minutes)		
Fish Size	Mg O ₂ /kg fish/hr	Oz O ₂ /lb fish/hr
5 inch (24 g)	255	41 x 10 ⁻⁴
6 inch (43.6 g)	310	50 x 10 ⁻⁴
7 inch (78 g)	375	60 x 10 ⁻⁴
(1 hour)		
Fish Size	Mg O ₂ /kg fish/hr	Oz O ₂ /lb fish/hr
5 inch (24 g)	240	39 x 10 ⁻⁴
6 inch (43.6 g)	325	52 x 10 ⁻⁴
7 inch (78 g)	375	60 x 10 ⁻⁴
(2 hours)		
Fish Size	Mg O ₂ /kg fish/hr	Oz O ₂ /lb fish/hr
5 inch (24 g)	215	35 x 10 ⁻⁴
6 inch (43.6 g)	340	55 x 10 ⁻⁴
7 inch (78 g)	345	55 x 10 ⁻⁴

REARING PONDS

A

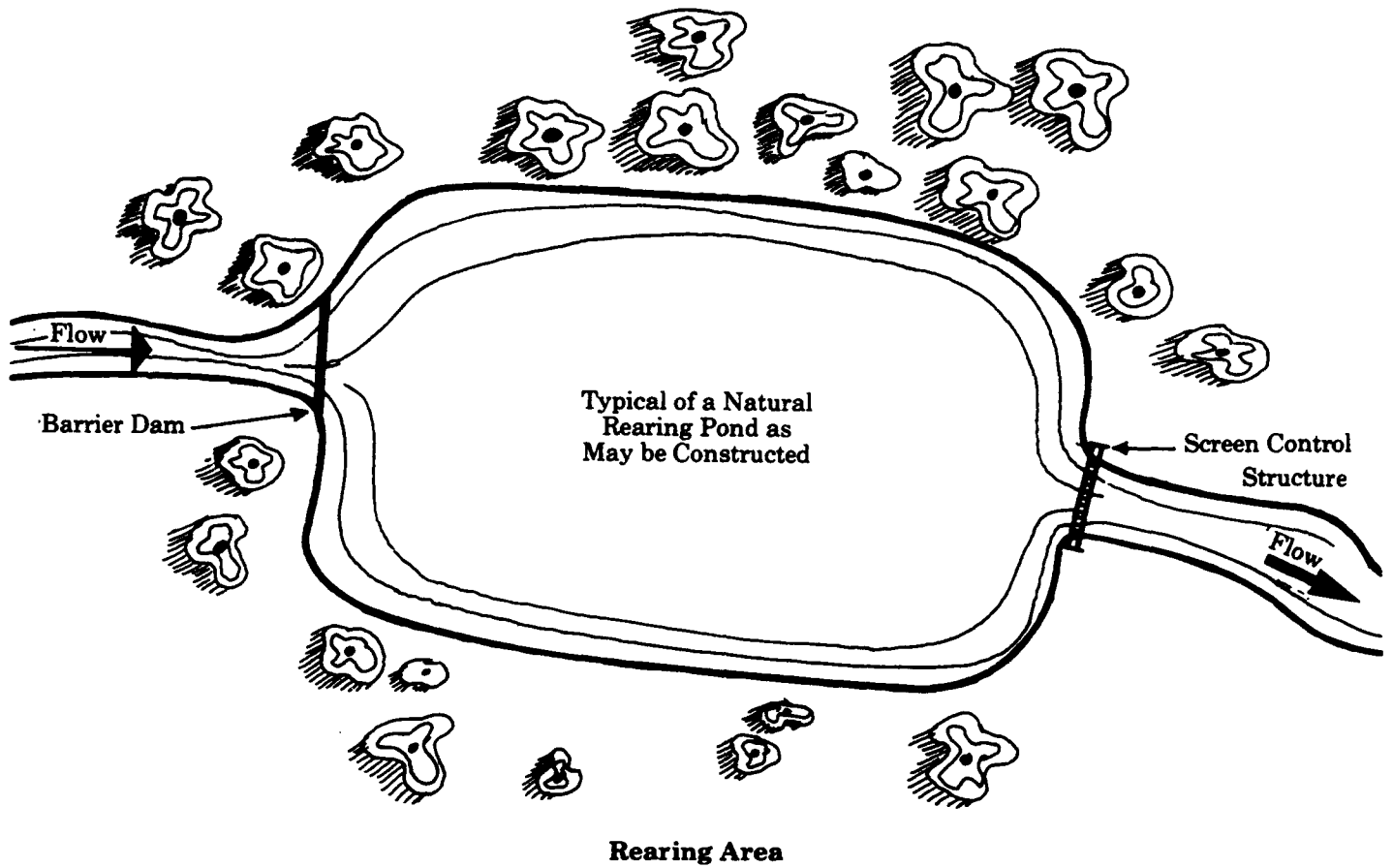

REARING PONDS

B

Potential Composition of Effluent From Rearing Ponds

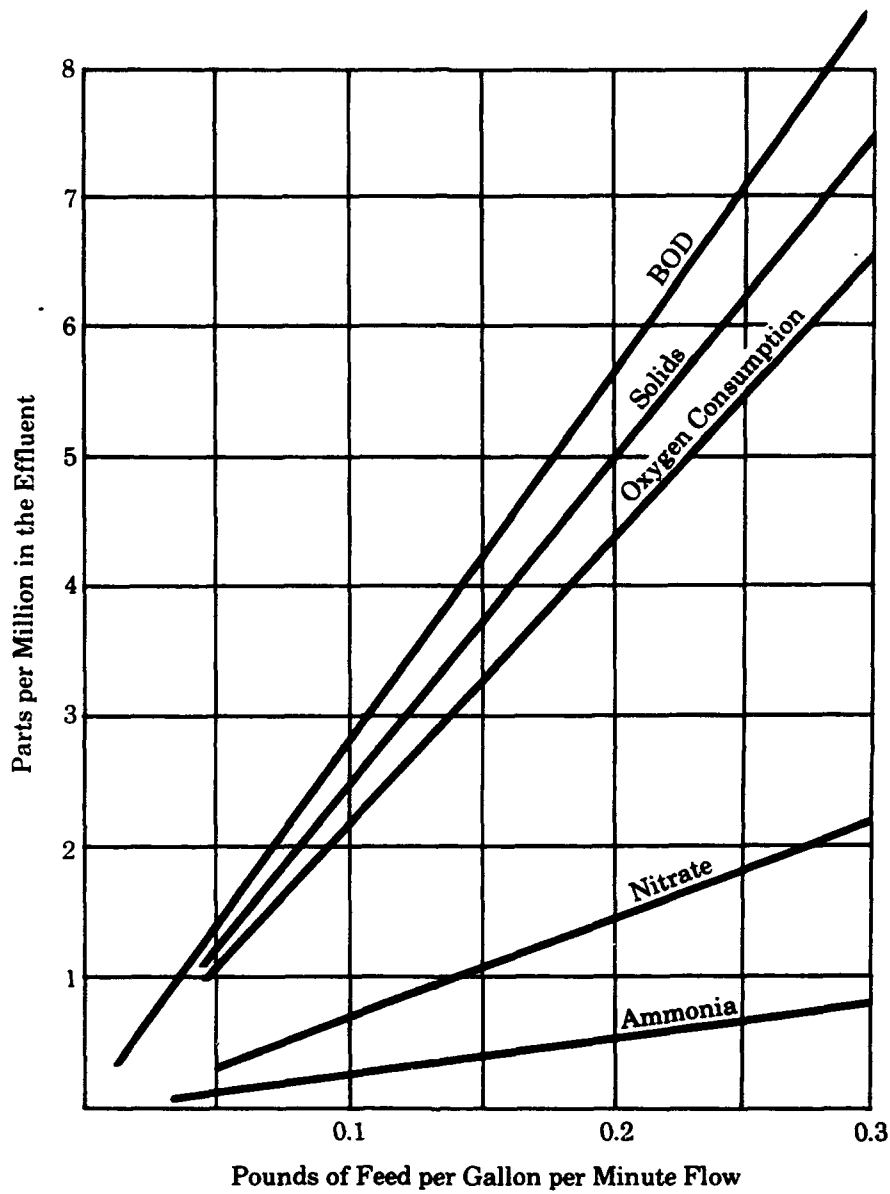

(Removal of 90 percent of the settleable solids removes 85 percent of the BOD).

From Willoughby et al., 1972.

See Reference No. 10.

REARING PONDS

References Reviewed

1. Brett, J.R., "Fish-energy cost of living." In: *Marine Aquaculture*, W.J. McNeil, Editor. Oregon State University Press, pp. 37-52. 1970.
2. Brett, J.R., and C.A. Zala, "Daily pattern of nitrogen excretion and oxygen consumption of sockeye salmon, *Oncorhynchus nerka*, under controlled conditions." *J. Fish. Res. Bd., Canada*, 32:2479-2486. 1975.
3. Elliott, Joseph, "The oxygen requirements of chinook salmon." *Prog. Fish Cult.* 31(2):67-73. 1969.
4. Fry, F.E.J., "The aquatic respiration of fish." In *Physiology of fishes*. Vol. 1, M.E. Brown, Editor. New York, Acad. Press. 1957.
5. Fry, F.E.J., "The oxygen requirements of fish." In *Biological problems in water pollution*, compiled by C.M. Tarzwell, Transactions of the second seminar on biological problems in water pollution, Water Supply and Water Poll. Research Program. Robert A. Taft Sanitary Engineering Center, 222 pp. 1970.
6. Idler, D.R., and W.A. Clemens, "The energy expenditures of Fraser River sockeye salmon during the spawning migration to Chilko and Stuart lakes." *Int. Pac. Salmon Fish. Comm. Prog. Rep. No. 6*, 80 pp. 1959.
7. Groot, C., and W.L. Wiley, "Time lapse photography of an ASDIC echo sounder PP1-scope as a technique for recording fish movements during migration." *J. Fish. Res. Bd. Canada*, 22:1025-1034. 1965.
8. Johnson, W.E., and C. Groot, "Observations on the migration of young sockeye salmon, *Oncorhynchus nerka*, through a large, complex lake system." *J. Fish. Res. Bd. Canada*, 20:919-938. 1963.
9. Doudoroff, P., and D.L. Shumway, "Dissolved oxygen requirements of fishes." *FAO Fisheries Tech. Paper No. 86*, 291 pp. 1970.
10. Willoughby, H., H.N. Larsen, and J.T. Bowen, "The pollutional effects of fish hatcheries." *Amer. Fish. and U.S. Trout News*, 17(3):6,7, and 20. 1972.
11. "A comprehensive plan for the anadromous fish hatchery program for the State of Michigan, Volume I, General Considerations and Site Selections." Prepared for the Dep. of Conservation of the State of Michigan by Carey and Kramer (Consulting Engineers), and Johnson and Anderson (Consulting Engineers), p. 2.21. 1968.
12. Brett, J.R., "The metabolic demand for oxygen in fish, particularly salmonids, and a comparison with other vertebrates." *Respiration Physiology* 14:151-170. 1972.
13. Piper, R.G., "Know the proper carrying capacities of your farm." *Amer. Fish. and U.S. Trout News*, 15(17):4-6 and pg. 30. 1972.
14. Senn, Harry, John Mack and Lloyd Rothfus, "Compendium of low-cost Pacific salmon and steelhead trout production facilities and practices in the Pacific Northwest." For U.S. Department of Energy, Bonneville Power Administration, Portland, Oregon. September, 1984.
15. Haskell, David C., "Trout growth in hatcheries." *New York Fish and Game Journal*, 6(2):204-237. July, 1959.

Chapter 21

Fish Diseases - Types, Causes and Remedies

Concern principally in hatching production.

Most disease organisms treatable and controlled.

Fish diseases divided into several categories: Nutritional or organic, bacterial, virus, external parasites, internal parasites and fungi.

Index of Fish Diseases

Nutritional or Organic Diseases:
Nutritional or Dietary Gill Disease.
Hepatoma of Rainbow Trout.

Bacterial Diseases (External):
Bacterial or Eastern Gill Disease.
Columnaris.
Fin-Rot.
Cold-Water or Peduncle Disease.
Sporocytophaga sp.

Bacterial Diseases (Internal):
Bacterial Hemorrhagic Septicemia.
Kidney Disease.
Furunculosis.
Fish Tuberculosis.
Ulcer Disease of Trout.
Vibrio Disease.

Virus Diseases:
(IPN) Infectious Pancreatic Necrosis.
(IHN) Infectious Hematopoietic Necrosis.
Lymphocystis.

External Protozoan Parasites:
Trichodiniasis.
Costiasis.
Ichthyophthiriasis.
Parasitic Copepods.

External Parasitic Worms:
Gyrodactylus.

Internal Protozoan Parasites:
Hexamitiasis.
Myxosporidia.
Ichthyosporidium.
Salmon Poisoning Disease.
Blood Fluke.
Haplosporidia.

Fungus Disease

White Spot Disease

Table 1. Vitamin deficiency symptoms in fish.

References Reviewed.

FISH DISEASES - Types, Causes and Remedies

Fish diseases are of concern principally in hatchery production. Epidemics may occur occasionally under natural conditions, more often in lakes and reservoirs, than in fast-running streams. When these occur in the wild they usually are due to widespread parasitic infestation. In hatcheries, fish are more susceptible to all types of infections. When disease occurs in a hatchery it is more readily apparent, and in the past frequently has impaired the success of artificial propagation.

Formerly some fish diseases, and particularly parasitic infestations, as *Ichthyophthirius*, were commonly accepted as being ever present and an inescapable source of loss in hatchery operations. Today, with present methods of disinfecting water supplies, pasteurization of fish food ingredients, and new therapeutic chemicals, most disease organisms are treatable and controllable. The use of wild fish and eggs from wild fish in artificial propagation, together with transfers of fish and eggs between stations, requires a continuing effort to prevent the spread of infectious diseases and resultant loss.

Although some diseases that formerly caused large losses of hatchery fish are no longer of major concern, the fish culturist is still beset with a formidable array of fish pathogens. Most fish disease outbreaks in a hatchery are now recognized in their early stages and, with the new and improved drugs and better treatment procedures, are controlled before they reach epidemic proportions.

Fish diseases may be divided into several categories. The proper category of a particular disease outbreak must be established as a first step toward determining the cause and the adoption of remedial measures. These categories generally may be considered as nutritional or organic, bacterial, virus, external parasites, internal parasites, and fungi. No attempt is made to identify all of the diseases that may be contained in each of these categories. However, the more common ones are listed and described, together with the usual conditions of occurrence and suggested treatment.

Nutritional or Organic Diseases

Mortality of hatchery fish from these causes is not nearly as prevalent now as formerly, due to improved formulation of dry foods and better refrigeration and preparation of meat products. However, nutritional requirements vary between species and components vary in commercial food products. More work has been done on the nutritional requirements of salmonids than other species. There are known vitamin, protein, and mineral requirements. There is danger in excess amounts of carbohydrates in fish diets, as contained in cereals.

Vitamin deficiencies may cause symptoms similar to those caused by disease organisms. Table 1 gives a list of vitamins and their deficiency symptoms.

Protein deficiencies, expressed by lack of essential amino acids, are quickly apparent. Deficiency syndromes are loss of appetite and lack of growth.

Excess dietary fat causes damage to the liver and kidneys, including fatty infiltrations of these organs, and edema, or accumulation of fluids in the body cavity.

In order to assure proper nutritional values for fish after a proper diet is determined, good food storage and food preparation procedures must be maintained. Prolonged

storage should be avoided, as well as over-heating of cooked food products, or improper refrigeration. Quality control of fish food products also is essential.

Nutritional or Dietary Gill Disease

The widespread adoption of adequate vitamin-fortified diets has greatly reduced the incidence of this disease.

Occurrence: In salmon and trout being reared in fresh water.

Description and Symptoms: Gill filaments and lamellae swollen and fused, starting at the base of the lamellae. Affected fish are listless and lose appetite.

Causative Agent: Pantothenic acid deficiency in diet.

Treatment: Increase sources of pantothenic acid in diet. Beef, liver, milk, dietary yeast, and distillers' solubles are good sources of pantothenic acid.

Hepatoma of Rainbow Trout

Occurrence: Hepatoma has been noted and described in many species of fish for years. However, a high incidence of the disease occurred in hatchery-reared rainbow trout in the spring of 1960, focusing attention on the disease. Diet improvements have prevented additional major outbreaks.

Description and Symptoms: The disease is characterized by the presence of white nodules of varying size and number on the liver. In advanced stages the abdominal walls are distended by the internal tumors. Internally, the normal cell structure is broken down and necrotic and hemorrhagic areas occur. Metastases are sometimes found in the kidney. Outbreaks usually occur in yearling and adult fish.

Causative Agent: Nutrition has been shown to be the cause of sudden extensive outbreaks. Some investigators have considered that heredity and in-breeding of hatchery rainbow brood stock may make these fish more susceptible to the disease. Halver and others have shown that hatchery-reared rainbow trout are particularly susceptible to the carcinogenic effects of aflatoxin contained in cottonseed meal and peanut meal.

Temperature Range: Unknown, but apparently water temperature is not a factor.

Prevention: Since the disease is not infectious, the best preventive measure is an adequate diet, free of meal containing the carcinogenic aflatoxin.

Treatment: No effective treatment has been developed for fish after the disease is externally recognizable.

Bacterial Diseases (External)

Bacterial or Eastern Gill Disease

Occurrence: A common external bacterial infection found in hatchery-reared salmon and trout, but also reported in largemouth and smallmouth bass and black crappie.

Description and Symptoms: Proliferation of gill epithelium, due to irritation, and causing swollen, fused,

FISH DISEASES - Types, Causes and Remedies

club-like gill filaments and lamellae. This interferes with the normal exchange of gases in the gills, and thus impedes respiration. In severe infestations mortality of infected fish may occur quickly from large numbers of bacteria impeding respiration.

Infected fish become listless, lose color, have poor appetite, exhibit increased gill activity and extended opercles, and frequently have excess mucous on clubbed gills.

Causative Agent: Several species of myxobacteria may be present on the gills, either singly or together.

Temperature Range: Occurs over a wide range of water temperature, from 35 to 70 F.

Prevention: Since this disease seems to be associated with overcrowding of salmonid fingerlings, it has been recommended that standard 80 x 20 foot rearing ponds not be stocked in excess of 4 lb. of fish per gallon per minute of flow, and that dirt ponds and straight flow-through raceways not be stocked in excess of 6 lb. of fish per gallon per minute of flow.

The water supply should also be free of silt or other gill irritants, as well as possible upstream-infected fish populations.

Lignasan at 1 to 2 ppm is used effectively as a prophylactic at some stations, but may be acutely toxic in some water supplies.

Treatment: The treatment of choice, except for rainbow trout for which it is toxic, is 80% pyridyl mercuric acetate (PMA) at a concentration of 2 ppm for 1 to 3 consecutive days.

Since PMA is no longer readily available, Diquat is used at 8.4 to 16.8 ppm (2 to 4 ppm Diquat cation) for 3 or 4 consecutive days.

Hyamine 1622 at 2 ppm (active ingredient) for 3 or 4 consecutive days may be more effective than Diquat. In any case, reoccurrence of the disease may require repeated treatments.

Columnaris

Occurrence: A common, warm-water external bacterial infection which, in its advanced stages, may also become systemic and cause reinfection. Although usually occurring in epidemic proportions only in hatchery-reared salmonids, it also occurs in wild fish and in other species in fresh water.

Description and Symptoms: Forms lesions which may completely erode gills. Organism also frequently enters body of fish through any break or scratch in skin, forming yellow to orange circular eroded lesions which enlarge rapidly. When the lesion has penetrated to blood vessels, the infection may become systemic. The organism forms columnar mounds on the gills and body tissues, a characteristic which gives the organism its name. Body lesions are dish-shaped, with yellow slime around periphery. Disease develops and spreads rapidly under favorable conditions causing high mortality.

Causative Agent: One of the myxobacteria, *Chondrococcus columnaris*.

Temperature Range: High virulence strains and low virulence strains of *columnaris* are recognized. Outbreaks of high virulence strains occur when average water temperatures reach 60 F. and the low virulence strains become apparent when the average water temperature is over 68 F. A reduction in temperature may greatly reduce the severity of a disease outbreak.

Prevention: Removal of wild fish, if possible, from a hatchery water supply may prevent infection. Fish should not be crowded or handled when the water temperature approaches 60 F. or warmer.

Treatment: There are two standard treatment methods. One is by baths, either in PMA at a concentration of 2 ppm for several consecutive days, or in Diquat baths at 8.4 - 16.8 ppm for four consecutive days. If the infection is systemic (well advanced) it is necessary to add sulfamethazine to the diet in conjunction with the PMA baths.

The other method is to add Terramycin to the diet at a level of 4 grams per 100 lb. of fish per day for ten consecutive days. Terramycin usually is effective in eliminating the bacteria, both externally and internally. However, reinfection will soon occur if the disease organism is present and the water temperature favorable.

Fin-Rot

Occurrence: Fin-rot or tail-rot is an external bacterial disease which may occur among hatchery-reared salmonids of any age. However, epidemics usually occur only shortly after the fish have started feeding. These may be severe, with high mortality and poor appearance of survivors.

Description and Symptoms: Fin-rot may occur in conjunction with several other diseases, which may cause some confusion in identification and treatment. Typically, infected fish show a white discoloration along the outer edge of the fins. This extends toward the base of the fins as the disease progresses, destroying the fin, often leaving only a ragged remnant of fin rays.

Causative Agent: Not a great deal is known about bacterial fin-rot, partly because its general appearance may be almost identical with fin conditions associated with other diseases. However, there is considerable evidence that it is of bacterial origin, and is usually associated with myxobacteria. For unknown reasons, fin-rot usually follows egg-yolk disease or other difficulties encountered in poor incubation.

Temperature Range: Water temperature apparently is not a significant factor with this disease.

Prevention: Over-crowding and excessive handling should be avoided. When incidence of the disease is slight, removal of infected fish may be of benefit.

Treatment: In some cases treatment with a bactericide, such as PMA or Hyamine 1622, may be an aid in preventing spread of the disease.

Cold-Water or Peduncle Disease

Occurrence: This is an external bacterial infection occurring in hatchery-reared trout and salmon, especially in young coho. The disease usually occurs in epidemic propor-

FISH DISEASES - Types, Causes and Remedies

tions among alevins or fry that have just begun feeding.

Description and Symptoms: The most apparent characteristic of the disease is the erosion of the peduncle and often the complete loss of the tail. Lesions also may occur along the sides of the body, particularly on larger fish. Another symptom is the dark color of the caudal area, which increases as the disease progresses. In yolk-sac fry, the epithelium covering the yolk material is attacked and eroded. Loss of yolk material quickly causes mortality. Epidemics frequently are severe, often exceeding 50 percent in sac-fry.

Causative Agent: The disease is caused by one of the myxobacteria, *Cytophage psychrophila*. It may be carried by resident fish in the water supply.

Temperature Range: The distinctive feature of cold-water disease is that in production ponds the optimum temperature for outbreaks is 40-50 F. In yolk-sac fry the disease may persist and even increase in severity up to 60 F.

Prevention: The inclusion of sulfamethazine at low levels in the diet will aid in preventing outbreaks of the disease. There is evidence that with coho yolk-sac fry, outbreaks may be associated with excessive water velocity in deep troughs; therefore, if troughs are used, they should be the shallow type in order to provide sufficient dissolved oxygen at flows not over 4 to 5 gallons per minute.

Treatment: Daily baths with PMA or Hyamine 1622, accompanied by Terramycin at the standard level or sulfamethazine in the diet. Sulfa should be fed at 10 - 20 grams per 100 lb. of fish per day in starter diets, or 5 grams per 100 lbs. of fish per day in pelleted diets. Treatment may be required for 10 - 20 days.

Sporocytophaga sp.

Occurrence: An external myxobacterial infection found in chinook, coho, and sockeye salmon and steelhead trout when reared in seawater.

Description and Symptoms: The disease forms large lesions on the sides and abdominal surface of infected fish. The skin around lesions has the appearance of having been ground away or "sandpapered."

Causative Agent: Lesions are filled with a myxobacterium which has been found to belong to the genus *Sporocytophaga*.

Temperature Range: Unknown.

Prevention: Terramycin and Aureomycin are reported to be effective against this and other marine myxobacteria at a level of 1 ppm in the water.

Treatment: PMA (pyridylmercuric acetate) is effective against this disease, but may not be readily available. Lignasan is also reported to be satisfactory at a concentration of 1 ppm for one hour on four consecutive days.

Bacterial Diseases (Internal)

Bacterial Hemorrhagic Septicemia

Occurrence: This is an insidious internal disease condition which is not adequately known or completely understood. It, or closely related forms, may infect fingerling and adult salmon and trout. It may occur among only a few individual fish, or it may assume epidemic proportions. It is closely related to the "red-mouth" disease of rainbow trout, as well as to the "red-vent" disease of salmon. It occurs in both salmonids and other cold-water fish, as the "red-sore" disease of pike, as well as in warmwater pond fish.

Description and Symptoms: Since the disease is septicemic, the causative bacteria usually are present in the blood and internal organs. The abdominal cavity usually is distended and filled with slightly opaque or bloody fluid. The kidney may be swollen and soft, the liver pale, small hemorrhages present in the peritoneum and muscles. The lower intestine and vent are usually swollen, inflamed, with bloody contents. Externally there may be superficial shallow grayish or red ulcers. The area around the mouth may be inflamed and eroded as occurs in "red-mouth" disease of rainbow trout.

Causative Agent: The disease is caused by any or several members of the *Aeromonas* and *Pseudomonas* groups of bacteria. Prominent among these is *Aeromonas liquefaciens*, although a number of other forms have been isolated and described. The "red-mouth" disease of rainbow trout has long been attributed to *Pseudomonas hydrophila*.

Temperature Range: Since this disease or closely related forms occur in both coldwater and warmwater fish, it must be assumed to cover a wide range of water temperature conditions. However, it has been observed that outbreaks usually occur, at least in warmwater ponds, along with a prolonged increase in water temperature. This normally occurs in the spring.

Prevention: Inasmuch as one of the organisms commonly associated with this disease, *Aeromonas liquefaciens*, is commonly associated with decaying organic matter, it is assumed that dead fish or an undue accumulation of excess food or excrement on pond bottoms may provide a medium for disease transmission. Excess handling such as occurs in grading, marking, weighing or any undue source or stress may trigger the disease if it is present.

Infected fish should of course be removed, although other unknown carriers may be present. These may include frogs or infected protozoan parasites, thus making it difficult to eliminate the disease with any certainty.

Treatment: Terramycin or chloromycetin in the diet at a rate of 2.5 to 3.5 grams per 100 lb. of fish fed is usually the preferred treatment. This may have to be repeated several times at two to three week intervals. The sulfonamides, as sulfamethazine or sulfamerazine, may also be effective, particularly against "red-mouth" disease in trout. However, Sullmet is not effective against outbreaks caused by *Aeromonas liquefaciens*. Sulfonamides may be included in the diet at a rate of 10 grams per 100 lbs. of fish per day.

FISH DISEASES - Types, Causes and Remedies

Kidney Disease

Occurrence: This internal bacterial disease formerly caused high mortalities among all species of hatchery-reared salmon up to yearling size. It is also found among young wild salmon fingerlings, which in some cases may be a source of hatchery infection. It also has had serious outbreaks among hatchery-reared trout. It is also thought to occur in adult salmon.

With the widespread adoption of improved, pasteurized fish foods in the past four to five years, this disease no longer is normally a cause of great concern in artificial propagation.

Description and Symptoms: The disease organism circulates in the blood stream of infected fish, multiplies slowly, and forms foci of infection in the internal organs. These are primarily in the kidney, where blisters and ulcers occur. The liver, spleen, and heart may also be centers of infection and exhibit pus-filled lesions. The blisters may extend into the muscles, forming externally visible blebs under the skin, which may develop into deep external lesions. As the kidney breaks down, excess fluid may occur in the body cavity, causing great distention of the abdomen. An exophthalmic condition or "pop-eye" also may occur. In the latter stages of the disease, the smaller capillaries in the skin may rupture giving the skin a red-speckled appearance. Hemorrhaging may also occur at the base of the fins.

Causative Agent: The disease recently has been determined to be caused by a small unnamed diplobacillus of the genus *Corynebacterium*. It may enter the fish either from infected food or from infected fish in the hatchery or water supply. There is considerable evidence that a former major source of the disease was the feeding of infected carcasses and viscera of infected adult salmon.

Temperature Range: The disease occurs over a wide range of water temperatures. The incubation period is rather long, being 60 to 90 days at water temperatures of 45 - 50 F., and 30 to 35 days at temperatures above 52 F.

Prevention: Salmon viscera should not be fed unless it has been pasteurized. Cottonseed meal in the diet apparently provides more resistance to the disease in young salmon than corn gluten. A low level of sulfamethazine in the diet (2 grams per 100 lb. of fish per day) is used as a prophylactic measure, but may result in a sulfa resistance. Infected fish act as carriers and should of course be removed from the hatchery and, if possible, from the water supply.

Treatment: Control remains mainly a matter of good preventive measures rather than treatment. Temporary control in trout has been obtained with the inclusion of 8 to 10 grams of Gantrisin or sulfamerazine per 100 lb. of fish per day. Frequently, treatment must be repeated for one week each month. Erythromycin in the feed at the rate of 4.5 grams per 100 lb. of fish per day for three weeks gave the best control under laboratory conditions. However, a completely satisfactory treatment has not been found.

Furunculosis

Occurrence: Furunculosis is an internal bacterial disease which was known in Europe for many years before it was brought to this country. All salmonid fish are susceptible, both hatchery-reared and wild fish. It is also found among many other fish species. The bacterium may enter

fish either through an open scratch or wound, or through the digestive tract. In its acute stage it is systemic, and is carried throughout the body by the blood stream. Formerly this disease often reached epidemic proportions which were impossible to control, and it was responsible for enormous mortalities. In recent years effective control measures have been developed.

Description and Symptoms: As indicated by its name, the disease frequently gives rise to deep, boil-like lesions on the body. Other typical symptoms are blood-shot frayed fins, particularly the dorsal. There may be a bloody discharge from the vent, and internally there may be many small hemorrhages in the tissues. Necrosis of the kidney may occur, and the spleen will be bright red and swollen. In acute stages the gills may be pale or white, due to a breakdown of the capillaries.

Causative Agent: Furunculosis is caused by a water-borne bacterium, *Aeromonas salmonicida*.

Temperature Range: The disease can occur over a wide range of water temperatures. However, the optimum incubation temperature for outbreaks in salmon usually occurs between 56 and 70 F., when the disease develops and spreads rapidly, becoming apparent within a week of infection. Below 45 F. the infection becomes latent, without further development of symptoms or increased mortality.

Prevention: Since the bacterium may occur on eggs taken from infected fish, any eggs transferred from hatcheries where the disease occurs should be disinfected with sulfamerthiolate or acriflavine.

Where possible, infected fish above a hatchery water supply should be removed. Rough fish spawning above a hatchery water intake frequently are a source of infection.

Treatment: The usual treatment is by the addition of one of the sulfonamides to the diet at a rate of 10 grams per 100 lb. of fish per day. However, some strains of the bacterium are sulfa-resistant. Among the antibiotics, Terramycin or Chloromycetin, have proved effective when fed at a rate of 2.5 to 3.5 grams per 100 lb. of fish per day. Furazolidone (Furozone) also has been found effective when properly fed; n180, a commercial product containing 11 percent furazolidone is effective when fed at a rate of 25 to 35 grams per 100 lb. of fish per day for 10 days. However, if a wet diet is used, the n180 must be added immediately before feeding, as it is destroyed by the presence of fresh meat or fish products.

A most promising treatment is the recent development of an oral vaccine called FSA (furunculosis soluble antigen). This antigen provides temporary protection lasting several weeks or months, depending on the initial level and water temperature. It is added to the diet in small amounts, and is most evenly distributed in food for hatchery use by inclusion in the food manufacturing formula.

Fish Tuberculosis

Occurrence: Despite its name, this disease is not related to the organism causing tuberculosis in warm-blooded animals, and it cannot be contracted by them. It occurs in many species of fish in both fresh and salt water. Fish tuberculosis is an internal, chronic bacterial infection which formerly was quite prevalent in hatchery reared salmon. It now

FISH DISEASES - Types, Causes and Remedies

occurs only rarely and is not of serious concern to fish culturists.

Description and Symptoms: In salmon the disease may invade almost every tissue of the body. The infection is chronic and develops slowly, taking one to four years to become apparent. Typically, caseous (cheeselike) lesions are found in the liver and kidney after the fish are more than two years old. Similar small lesions may be found in the spleen, intestine, and pyloric caeca. Adhesion of these organs may also occur.

During spawning migration small gonads are found on adult salmon having the disease. They also may fail to develop any of the secondary sexual characteristics normally present in mature salmon at time of spawning, and the sexes cannot easily be determined from external examination. Growth is also affected, the mature diseased fish having an average length of several inches less than normal. The time of the spawning migration of diseased fish is also irregular, such fish returning from the ocean during any month of the year.

Causative Agent: The disease is caused by various species of bacteria belonging to the genus *Mycobacterium*.

Temperature Range: Not known, but apparently not a significant factor.

Prevention: It has been repeatedly demonstrated that the causative organism is transmitted by the feeding of raw carcasses or viscera of infected fish. When this practice was continuous the prevalence of the disease increased with each life cycle. Since this practice was abandoned the incidence of the disease has become negligible in hatchery production.

Treatment: No effective treatment, either prophylactic or therapeutic, has been developed.

Ulcer Disease of Trout

Occurrence: Ulcer disease is an internal bacterial infection. It occurs primarily in brook trout, but brown and lake trout are also susceptible. Rainbow trout are resistant but not immune. The disease is the cause of considerable concern in trout hatcheries in the northeastern part of the United States and eastern Canada, where it causes high mortalities.

Description and Symptoms: Typically the disease manifests itself in shallow open ulcers on the sides of the body. Lesions may also occur on the fins, which then become frayed, and the tissue between the fin rays is destroyed. Frequently the symptoms may be confused with those of furunculosis, especially since it may often occur in association with the latter disease. Frequently, the jaws and roof of the mouth become infected and are eroded away. In its early stages the disease occurs as small, whitish pimples or tufts resembling small patches of fungus, which can appear on almost any part of the body. These develop into small, circular, shallow ulcers, usually red, which increase in size and may form a large irregular lesion. When external symptoms are absent, the organism can be found in the kidney. In active infections the disease becomes septicemic. The best diagnosis is made by bacteriological methods, since the disease resembles other ulcer forming infections.

Causative Agent: Ulcer disease is caused by a bacterium, *Hemophilus piscium*. Adult fish frequently act as carriers. It may be transmitted through the water or in food contaminated by bacteria present in the water or feces.

Temperature Range: It is reported that the disease will not break out at water temperatures below 45 F.

Prevention: Trout eggs from sources where the disease is known occur should be disinfected before being brought into the hatchery.

Where possible, infected carrier fish should be eliminated from the hatchery water supply.

Sanitary measures should be rigorously followed in the hatchery and rearing ponds.

Treatment: The most effective treatment is by the addition of antibiotics such as Terramycin or chloramphenicol to the diet at a level of 2.5 to 3.5 grams per 100 lb. of fish per day until the outbreak is under control. The sulfonamides usually are not effective, but may be of some help if the fish are resistant to the disease.

Vibrio Disease

Occurrence: This disease normally may occur in all species of salmon being reared in salt water. It also has been reported to occur in trout being reared in fresh water that are fed the raw flesh of infected marine fish. It also occurs in wild marine fish, and has been found in herring.

Description and Symptoms: The disease is well described as a bacterial hemorrhagic septicemia, and was formerly called "salt water furunculosis" because of the resemblance to the symptoms of the latter disease. Typically, large bloody lesions appear in the skin and throughout the musculature, due to the breakdown of blood vessels and tissues. The gills bleed easily, and a bloody discharge may be expressed from the vent. Hemorrhaging of the eyes also occurs, and may be the only external symptom observed. In small fingerlings death may occur before any external symptoms are apparent.

Causative Agent: The disease is caused by one or several bacteria of the genus *Vibrio*.

Temperature Range: All known outbreaks have occurred at water temperatures over 50 F., and the most severe at temperatures near 60 F.

Prevention: Salmon being reared in salt water should not be subjected to undue stress, as in handling, especially at abnormally high water temperatures or low dissolved oxygen levels. The organism may be acquired by the salmon being fed raw fish carcasses, or it may be transmitted by infected carrier fish. When an outbreak is expected, as during periods of abnormally high water temperature, sulfamethazine should be included in the feed as a prophylactic measure at a level of 2 grams per 100 lb. of fish per day throughout the critical period.

Treatment: The disease may be effectively controlled by the addition of Terramycin to the diet at a level of 2.5 to 3.5 grams per 100 lb. of fish, or sulfamethazine at the normal level of 10 grams per 100 lb. of fish per day, for a ten day period.

FISH DISEASES - Types, Causes and Remedies

Virus Diseases

The field of virus diseases in fish was little known in the past, and it is probable that many puzzling outbreaks for which no causative agents could be isolated were caused by virus infections. In recent years the accepted clinical methods of virus determination have been used to establish the presence of a virus as the causative factor in several severe disease outbreaks among both trout and salmon in hatchery-reared fish.

Infectious Pancreatic Necrosis

Occurrence: This disease, commonly called IPN, occurs primarily in brook trout, although it also has been found in rainbow, brown, cutthroat, and Atlantic salmon. It apparently is identical with a disease which earlier was called "acute catarrhal enteritis." It is extremely infectious, occurs among young salmonoid fish shortly after they start feeding, and may cause mortalities as high as 80 percent.

Description and Symptoms: Typically, the young infected fish whirl or swim in a horizontal spiraling manner. The fish may at times swim in a frenzied manner, alternating with quiescent periods when they may rest on the bottom. Internally, the stomach and interior intestine are filled with a thick, clear or slightly whitish mucous material, distended, and empty of food. The spleen and liver may be almost colorless. Severe necrosis of the pancreas and hyaline degeneration of skeletal muscle are also characteristic of the disease.

Causative Agent: Accepted clinical methods have demonstrated that the disease is caused by a virus. The microscopic lesions are almost identical to those of the Coxsackie virus in mice.

Temperature Range: Unknown; the disease is reported to be less common in hatcheries having constant-temperature spring water.

Prevention: The disease is extremely contagious. Suspected carrier fish should be removed from the water supply and the hatchery. The disease may be water-borne, or transmitted by ingestion of infected food. Strict sanitary measures are necessary to prevent spread of the infection.

Treatment: No effective treatment is known for infected fish. Like most virus diseases, it does not respond to any known chemotherapy.

Infectious Hematopoietic Necrosis

This disease, IHN, has been known by other names during the last three decades.

Occurrence: IHN has caused high mortalities in sockeye and chinook hatcheries, and is said to be present in steelhead. It is also found in adult wild stocks. It is extremely infectious. It is carried by infected adult salmon spawners, and it may be transmitted by the feeding of raw infected carcasses and viscera. It is also transmitted horizontally (fish to fish). The incidence of IHN has been reduced to a low level when the feeding of raw carcasses and viscera has been reduced.

Description and Symptoms: Symptoms vary with the size of the fingerlings infected. If the disease occurs in the Spring when the fish are small, the typical symptoms are

lethargy, side-swimming, erratic behavior, pop-eye, and hemorrhaging at the base of the fins. Surviving fish often develop spinal deformities. If an outbreak occurs in the following Fall when the fish are larger, the hemorrhaging symptom is more prevalent. Reddish areas also develop along the sides, small hemorrhagic areas occur in the visceral fat, and the intestine also may be inflamed.

Causative Agent: Accepted clinical methods have shown that the disease is caused by the IHN virus.

Temperature Range: The disease occurs over a wide range of water temperatures, being virulent from 40 to 60 F.

Prevention: Practice of feeding raw carcasses and viscera should be discontinued. As much space room as possible should be provided for the young. Eggs, if transferred, should be treated by organic iodine. Care must be taken so that individual eggs receive treatment. Infected fish should be destroyed and the facility disinfected. The hatchery effluent should be sterilized by the use of chlorine, which requires a retention time.

Treatment: There is no known effective treatment.

Lymphocystis

Occurrence: This virus disease occurs in a number of marine and freshwater fish. It is most apparent among some that are artificially propagated in fresh water, including the walleye and many of the Centrarchids or sunfish family. The disease has not been reported among salmonids. It is of a chronic nature which is seldom if ever fatal.

Description and Symptoms: The disease is characterized by external lesions, although these may also occur internally. Host cells which become infected are stimulated to abnormal growth. These raised growths of tissue enlarge until they burst, releasing virus particles into the water. Among Centrarchids the lesions are usually limited to the fins, and commonly the caudal fin is the principal site of infection. In some fishes, lesions may occur on any portion or over the entire body. Hemorrhagic areas occur during acute stages.

Causative Agent: It is well established that the disease is caused by a virus which is water-borne and transmitted by infected fish.

Temperature Range: Unknown; apparently the disease occurs over a wide range of water temperatures.

Prevention: The only preventive measure known is to remove and destroy all infected host fish from the hatchery or pond water supply.

Treatment: No effective treatment of infected fish is known.

External Protozoan Parasites

Trichodiniasis

Occurrence: Several species of Trichodina commonly parasitize many species of fish in fresh water, both warm-water and cold-water species, including the salmonids. The parasite is found on both hatchery reared and wild fish. When numerous, they can cause serious losses among

FISH DISEASES - Types, Causes and Remedies

hatchery-reared fish. The disease disappears from downstream salmon migrants when they enter salt water.

Description and Symptoms: When abundant, the organism may cause considerable irritation of the gills, as well as to the skin and fins. The fins may become frayed and irregular whitish areas appear on the skin. A typical symptom is frequent flashing of infected fish in attempts to remove the irritating parasites. The fish develop a tattered appearance if untreated and suffer loss of appetite.

Causative Agent: A number of species of this ciliated protozoan parasitize various species of fish. Apparently, one species infects chinook and another coho salmon. Other species are found on trout and other fishes. The parasite is transmitted directly and rapidly from close association with infected fish.

Temperature Range: Unknown; water temperature below 50 F. do not inhibit the parasite, which apparently has a wide temperature tolerance.

Prevention: Uncrowded ponds and adequate dissolved oxygen will aid in preventing rapid spread of the disease in hatchery ponds.

Treatment: Fortunately, *Trichodina* responds readily to treatment. It can readily be controlled by formalin, salt, PMA, Diquat, malachite green, or acetic acid. Formalin baths at a concentration of 1:6,000 for one hour is the preferred removal treatment. Where ponds are not conducive to flushing, or where secondary bacterial infection is suspected, Diquat at 8.4 or 16.8 ppm, for four consecutive days is recommended.

Costiasis

Occurrence: This is a common external parasitic infestation of both trout and salmon. It is introduced into hatcheries from wild host fish. The disease is most destructive among fry and young fingerlings, although older fish may also suffer losses. The disease may occur among alevins in the hatchery, but severe losses usually do not occur until the young fish have started feeding. The organism may often be present in salmon hatcheries without causing an epidemic unless conditions are favorable for an outbreak, such as overcrowding or poor nutrition. Migration to salt water does not halt the infection.

Description and Symptoms: The parasite typically infects the gills and fins and, in heavily infected fish, a bluish film may spread over the entire body. This disease may cause death with any drastic tissue changes.

Young infected fish may become very lethargic. Sudden flashing may be evident when the body surface is infected.

Causative Agent: The disease is caused by a small protozoan flagellate, *Costia necatrix*. Positive identification is made only under the microscope.

Temperature Range: Unknown; may occur at all normal salmon or trout hatchery temperatures.

Prevention: Young fish should not be overcrowded. A good balanced diet should be maintained. Formalin baths at a concentration of 1:6,000 for one hour may be used as prophylaxis, provided that bacterial gill disease is not

present. Formalin is lethal if fish are weakened by bacterial gill disease.

Treatment: The preferred treatment is the formalin bath, as indicated. This may need to be repeated. An acetic acid dip at 1:500 concentration also is reported to give good results.

Ichthyophthiriasis

Occurrence: This is the most widespread external parasitic disease of fish. It is found on a wide variety of species, including warm-water species as well as salmon and trout. It occurs on both hatchery-reared and wild fish. The causative organism is frequently present in hatchery ponds, but not lethal except to young fish under optimum conditions for the causative organism.

Description and Symptoms: The parasite typically infests the epithelial layers of the gills, fins and skin. The infestation can be detected visibly, and appears as small, grayish white swellings on the body and fins. Young infected salmon exhibit considerable flashing, jumping, and erratic movement. As the parasite develops, the fish become listless and dark in color. When mature, after a period of ten days to five weeks, depending on water temperature, the parasite drops off the host fish and settles to the bottom of the pond. Here it encysts and multiplies. After several days, depending on water temperature, the cyst bursts and a large number of the minute, free-swimming ciliates emerge and actively seek a host fish, where they bore into the epithelium and repeat the life cycle.

Causative Agent: The disease is caused by a ciliated protozoan, *Ichthyophthirius multifiliis*.

Temperature Range: This is a comparatively warm-water disease. The organism frequently is present but inactive at low water temperatures. The disease often breaks out in salmon fingerlings, especially chinook, at water temperatures above 60 F. The optimum temperature for the organism has been noted as 77 to 80 F.

Prevention: Removal of infected host fish from the water supply where possible will reduce the source of infection in hatchery ponds.

Lowering the water level and increasing the water velocity in raceway ponds every few days for a period of several hours will wash out the cysts and free-swimming stage of the parasite and reduce the incidence of infestation during periods of high water temperature.

Treatment: There is no effective treatment of the host fish after the parasite is embedded in the epithelium. However, the infestation may not be lethal, and reinfestation can be prevented. The cysts and free-swimming stages are easily killed by a variety of chemical treatments. The preferred treatment is a formalin bath at a concentration of 1:6,000 for one hour, repeated daily until all the parasites leave the host fish. This usually requires about four days at 70 degrees F., or thirty or more days at 50 F.

Parasitic Copepods

Occurrence: Several species of these parasitic crustaceans infest trout and salmon, including both wild and hatchery-reared fish. They are found in both fresh and salt

FISH DISEASES - Types, Causes and Remedies

water, and may sometimes occur in sufficient abundance to be troublesome, particularly in trout hatcheries. Adult fish usually are more heavily parasitized than fingerlings.

Description and Symptoms: The most common copepod infestation is easily observed. The organism is typically attached to the gills and fins. It is relatively large, several millimeters in length, and is yellowish-white in color. The organism commonly observed is the female, bearing a pair of long egg sacs posteriorly, within which the embryos undergo complete development. When fully developed, the egg sacs break open and the young, free-swimming larvae actively seek another host.

While attached to the gills the parasite debilitates the host fish by sucking large quantities of blood, and also by mechanical injuries to the tissues, which often result in secondary infections.

Light infestations do little harm, but in overcrowded broodstock holding ponds, under optimum conditions for the parasite, considerable losses may occur. Such mortalities usually occur during the spawning season, when the vitality of the fish is already low.

Causative Agent: The most common form is *Salmonicola edwardsii*. Another form is found on a great variety of wild fish, and is named *Lernaea carassii* commonly called "anchor worm."

Temperature Range: Infestation occurs over a wide range of water temperatures.

Prevention: One obvious measure is to isolate infested fish. Host fish should be removed from the hatchery water supply where possible. The free-swimming larval stage may be prevented from entering the hatchery water supply by a sand filter.

Treatment: No effective measure has been developed for treatment of host fish after the parasite has become embedded in the gills and other tissues. However, the free-swimming larval stage is easily killed by a strong salt solution, by a formalin bath at a concentration of 1:6,000 for one hour, or by Lindane at concentrations of 1:10 million to 1:40 million.

Since the adult female copepod may remain alive on the host fish for two months or more, and normally lays two batches of eggs, chemical treatment may not be entirely effective.

Partial control also may be obtained by keeping infested host fish in ponds having increased water velocity, so as to wash out the free-swimming larval stage.

External Parasitic Worms

Gyrodactylus

Occurrence: This monogenetic trematode commonly infests trout, but also has been found on adult sockeye salmon. Very similar or possibly the identical species occurs on a wide variety of fish, including warm-water species. The organism is found in both hatchery-reared and wild trout. When ignored under overcrowded hatchery conditions the parasite may cause heavy mortality among trout.

Description and Symptoms: The parasite may occur almost anywhere on the host fish, but is usually most abundant on the dorsal and caudal fins, which become badly frayed and eroded. The affected body surfaces become covered with a bluish-gray slime due to the increased secretion of mucous. A low power lens will reveal the organism, usually attached to the host by a pair of curved hooks at the posterior end. They may also be observed slowly crawling over the surface of the fish. Infected fish often can be seen to rub themselves against the sides or bottom of the pond in an evident attempt to dislodge the parasite. Heavy infestations have an extremely debilitating effect on the host. A bad feature is that the disease make the host fish susceptible to fungus and other secondary infections.

Causative Agent: The infestation is caused by a monogenetic trematode, *Gyrodactylus elegans*.

Temperature Range: Unknown, but apparently the parasite occurs over a wide range of water temperatures.

Prevention: Infected fish should be removed from hatchery water supplies where possible. Increased water flow through holding ponds may aid in reducing the extent of infestation.

Treatment: The parasite can be easily controlled, and no hatchery need suffer serious losses from this organism. The preferred treatment is a formalin bath at a concentration of 1:4,000 for one hour.

Internal Protozoan Parasites

Hexamitiasis

Occurrence: This widespread hatchery disease, formerly called "octomitus" occurs in both salmon and trout being reared artificially. The disease formerly appeared in epidemic proportions, but in recent years has not been a serious source of trouble. It is believed that the former outbreaks probably were due to inadequate diets, and also may have been precipitated by overcrowding and size variation among fingerling fish.

Description and Symptoms: This small flagellated protozoan is found in the anterior intestine, stomach, and gall bladder of infected fish. The most serious outbreaks occur among fingerlings, and it is the young fish that suffer heavy mortalities. The most common symptom is the appearance of emaciated fish, commonly referred to as "pinheads." Infected fingerlings suffer loss of appetite and become weak and listless. In acute infestations, fingerlings may exhibit a whirling or corkscrew motion, or they may lie on the bottom of the trough or pond and bend the body from side to side with quick, spasmodic movements. The only sure method of diagnosis is by microscopical examination of the intestinal contents.

Causative Agent: The disease is caused by mass infestation of a protozoan flagellate, *Hexamita salmonis*.

Temperature Range: Unknown.

Prevention: The organism frequently appears in the intestinal tract of apparently healthy carrier fish, and may also exist in a free, resistant, dormant cyst stage. When the cyst is ingested by a host fish it quickly develops into the active flagellate. Because of these features of the life

FISH DISEASES - Types, Causes and Remedies

history, it is very difficult to eliminate the organism completely from a hatchery population.

The best preventive measures are to avoid overcrowding, provide an adequate balanced diet, and maintain uniform-sized fish in ponds by proper grading.

Treatment: Formerly, the classic treatment was by the addition of calomel at a level of 0.05 to 2.0 percent, or carbarsonate at a level of 2.0 percent, to the diet for four days. This flushed the intestinal tract and presumably removed most of the parasites. However, calomel is frequently toxic and also unpalatable to the fish. It has been suggested that epsom salts would be more satisfactory.

Myxosporidia

This is the largest group of internal protozoan parasites of fish; more than 700 species having been described. They are found in a wide variety of fish, including fresh-water, marine, and anadromous species, and in both hatchery-reared and wild fish. At least seven species have been identified as responsible for disease outbreaks in northwest salmon hatcheries. The following description is limited to *Ceratomyxa*, the most damaging myxosporidian found in this area.

Occurrence: This parasite has been found in chinook and coho salmon, as well as in trout, at several hatcheries in the lower Columbia River watershed, where it has been responsible for serious losses of adult fish. The disease also occurs in fingerlings. It also has been reported in rainbow and steelhead trout at a California hatchery. It is significant that all outbreaks of *Ceratomyxa* have occurred in hatcheries associated with a lake or reservoir, which appears necessary for formation of the infectious stage.

Description and Symptoms: As the name indicates, this entire class of Protozoa, called *Sporozoa*, is characterized by the formation and release of small resistant spores. This enables them to withstand unfavorable conditions outside the host, and renders them very difficult to eradicate.

The parasite multiplies throughout the tissues of the host fish. Infected adult chinook may exhibit nodules in the gut which may develop into perforated lesions causing death. Gross lesions may occur in the liver, kidney, spleen, and musculature, which abcess as they progress. Infected adult coho usually show grossly thickened intestinal walls and pyloric caeca before death. The life cycle of *Ceratomyxa* is not completely known. Mature spores may be formed and the death of the host occur within 20 to 30 days following initial infection.

Causative Agent: The disease is caused by a myxosporidian parasite, *Ceratomyxa shasta*.

Temperature Range: It appears that water temperatures above 50 F. are necessary for initial infection. The disease progresses more rapidly with increased water temperature.

Prevention: The best preventive measure where the disease has not occurred is to prohibit the transfer of eggs or fish from infected waters.

Where hatchery infection is known to be carried by the water supply, it may be possible to treat the water by any of several methods. These include chlorination or ultra-violet irradiation, thus preventing the entrance of the infectious stages of the parasite.

Treatment: No effective treatment is known for infected fish.

Ichthyosporidium

Occurrence: This sporozoan internal parasite may be found in many species of fish, both fresh-water and marine. It is of interest because it has been responsible for serious losses of yearling, marketable sized rainbow trout in several commercial hatcheries.

Description and Symptoms: Typically, the parasite attacks the kidney and liver, although the spleen and intestines also may be enlarged and infected. Externally, the organism causes lesions in the skin and gills.

Causative Agent: The disease is caused by a parasitic sporozoan, *Ichthyosporidium hoferi*. An oral route of infection is the normal means of transmission.

Temperature Range: Unknown, but the spores apparently are resistant to a wide range of water temperatures.

Prevention: Outbreaks in commercial rainbow trout hatcheries are known to have been caused by feeding the raw carcasses of infected carp. No untreated fish or meat products should be included in the diet.

Where possible, any infected fish in the hatchery water supply should be removed. Likewise, any infected fish in hatchery ponds should be removed, and the ponds drained and sterilized before reuse. Due to the resistant nature of the spores, eradication may be difficult.

Treatment: Control of this disease lies in prevention rather than treatment. No effective treatment is known for infected fish.

Salmon Poisoning Disease

There are a number of internal parasitic worms and flukes which may infest fish. Only infrequently do they interfere seriously with hatchery operations. One of particular interest is responsible for the "salmon poisoning disease" of dogs.

Occurrence: This disease is caused by a digenetic trematode, and occurs among a wide variety of fresh-water and anadromous fish where the parent or spawning stream supports a population of the specific snail intermediate host.

Description and Symptoms: The disease actually is caused by a rickettsian which parasitized the fluke. Both the fluke and the rickettsian remain viable in salmon while the fish are in the ocean. The adult form of the fluke attaches in the intestine of fish-eating carnivorous mammals, as dogs, bears, and raccoons. The mammalian host acquires the parasite by ingesting the encysted metacercaria contained in the raw flesh of infested fish. Eggs are discharged through the mammalian intestinal tract. If the eggs enter water they hatch as free-swimming miracidia. The miracidia must bore into a specific aquatic snail,

FISH DISEASES - Types, Causes and Remedies

Oxytrema plicifera, where they multiply and later leave the snail as free-swimming cercaria. Upon coming into contact with a fish, the cercaria bore in and encyst as metacercaria.

Large numbers of encysted metacercaria have a debilitating effect on young fish, which often appear emaciated. The optic nerve often is affected in heavy infestations, causing blindness and exophthalmos, commonly called "pop-eye."

Causative Agent: The so-called "salmon poisoning disease" is caused by the digenetic trematode or flatworm, *Nanophyetus salmincola*.

Temperature Range: Unknown.

Prevention: No effective measures have been developed to completely eradicate the intermediate host snail in streams. Where the hatchery infection is known to be carried by the water supply, the most promising measure is to continuously disinfect the water supply, thus destroying the free-swimming cercaria. This also might be accomplished by chemicals. Electric grids also have been reported to be effective for this purpose.

Treatment: No effective method has been devised to rid infested fish of the encysted metacercaria.

Blood Fluke

Occurrence: This disease is caused by a digenetic trematode, and is found in both trout and salmon where the parent or spawning stream supports a population of the specific snail intermediate host. This parasite has been known to cause serious losses among hatchery-reared rainbow and cutthroat trout. It is not known to have caused serious trouble in young salmon.

Description and Symptoms: The rather complicated life history of this parasite is somewhat similar to *Nanophyetus salmincola*, which is responsible for "salmon poisoning disease." The principal difference is that the blood fluke lives in the gill arteries of the host fish, where it lays eggs which lodge and develop in the gill capillaries.

Since the disease centers in the gills, a heavy infestation may inhibit respiration. The miracidia leaving the gills could also cause an extensive loss of blood and damage the gill epithelium. This also could make the host fish susceptible to secondary bacterial infections and fungus.

Causative Agent: In trout the parasite has been identified as the digenetic trematode, *Sanguinicola davisi*. The adult fluke has not been described in salmon, but probably is the same species.

Temperature Range: Unknown.

Prevention: In cases where the free-swimming larvae or cercariae are carried into a hatchery in the water supply, the ideal preventive measure is to destroy the snail intermediate host population upstream. Since this is seldom practicable or possible, in a heavily infested stream it may be advantageous to disinfect the hatchery water supply, either chemically or by means of an electric grid.

Treatment: No effective method has been devised to rid the gills of infested host fish of this parasite.

Haplosporidia

Occurrence: A member of this group of sporozoans is generally considered responsible for several hatchery and spawning channel infestations among adult chinook salmon and fry, and in adult coho salmon. It has been observed in both the Columbia and Sacramento River systems.

Description and Symptoms: This parasite typically infests the gills, but also may be found on the skin of the host fish. Mature cysts are readily visible on the gills as white spheres about 1 mm. in diameter. Each cyst contains myriads of small spores. The gill lamellae and filaments are drastically displaced by developing cysts. When cysts are formed in the skin they greatly resemble an infestation of *Ichthyophthirius*. Cysts on the gills of fry apparently interfere greatly with respiration. Adult fish seem to be able to withstand a relatively heavy infestation. However, the gill damage renders the fish much more susceptible to bacterial gill disease, fungus, and other secondary infections. Mature cysts are dislodged from the gills and drop to the bottom of the pond. The entire life cycle has not been described, but is supposed to be relatively uncomplicated.

Causative Agent: This parasitic infestation generally is considered to be caused by an organism belonging to the Haplosporidia, namely *Dermocystidium salmonis*.

Temperature Range: Unknown.

Prevention: No effective preventive measure is known except for the removal of infected fish.

Treatment: No effective treatment has been developed.

Fungus Disease

Occurrence: There are a number of aquatic fungi which may attack most fish and fish eggs in fresh water under conditions favorable for the plant growth. The zoospores which spread the infection are almost universally present in hatchery water supplies. Varying descriptions of fungus infections may be due in part to the several species which may occur.

Fungus may occur on any part of the fish, but normally enters and develops on any injured body surface, or in areas where the protective covering slime has been rubbed away. Frequently it occurs as a secondary invader following some bacterial or parasitic infection. Fungi tend to establish themselves on dead organic material in the water, as on dead eggs, or on surplus food particles in troughs and ponds, but soon spread to adjacent live organic material. Formerly, large losses of hatchery eggs sometimes occurred from fungi, but this is now easily prevented.

Description and Symptoms: Fortunately, fungi are easily visible and respond readily to chemical treatment. Typically, fungus appears as a tuft of white threads which extend and radiate from the body surface. The fungus is attached to the fish by means of small, root-like filaments which penetrate the skin and, in acute stages, may invade the underlying muscles. As the filaments grow through the skin, they kill the surrounding tissues and thus form large necrotic areas which may eventually kill the fish.

Causative Agent: The commonly observed fungus infection is due to the invasion of *Saprolegnia parasitica*.

FISH DISEASES - Types, Causes and Remedies

Temperature Range: Occurs over a wide range of water temperatures but develops more rapidly in warm water.

Prevention: The preferred method of fungus prevention for eggs is the addition of malachite green to the water supply, usually at a concentration of 1:450,000 for a one hour period several times a week. The optimum application must be determined in accordance with individual hatchery water quality conditions.

Treatment: Malachite green is preferred, and may be used at a concentration of 1:19,000 for ten to thirty seconds as an effective dip. A prolonged three percent salt bath may be substituted if other fungicides are not immediately available.

White Spot Disease

Occurrence: This disease manifests itself in the development of white spots (coagulated yolk) in eggs and is transferred to the embryo. If severe, the entire yolk becomes coagulated and the embryo dies.

Description: The tissues covering the yolk are ruptured and the leakage becomes coagulated.

Causative Agent: Severe or rough handling before the eye is developed and excessive shocking of the eggs can cause this disease.

Prevention: Avoid shocking by rough handling. White spot disease, if not severe, may disappear.

Table 1

Vitamin Deficiency Symptoms in Fish

Thiamine	Convulsions, neutritis, poor appetite.
Riboflavin	Cataracts, anaemia, dark colouration, photophobia, poor appetite.
Niacin	Swollen gills, intestinal lesions, poor coordination, flexing of opercles.
Pantothenic acid	Clubbed gills, anaemia, gill exudate, sluggish behavior, prostration.
Pyridoxine	Anaemia, hyperirritability, erratic swimming.
Cobalimin	Anaemia, fragmented and immature erythrocytes.
Folic acid	Anaemia, fragility of caudal fin, lethargy, pale gills, dark colouration
Biotin	Anorexia, pale gills, high glycogen in liver, colonic lesions.
Ascorbic acid	Spinal deformities, anaemia, lethargy, prostration, eye lesions.
Inositol	Anorexia, poor feed efficiency, skin lesions.
Choline	Haemorrhages, fatty livers, colonic lesions, poor feed efficiency.
Vitamin A	Cataracts, photophobia, anaemia, poor vision.
Vitamin D	Lethargy, increased lipid content of liver and muscle.
Vitamin K	Haemorrhages, pale gills, increased pro-thrombin time.
Vitamin E	Anaemia, exudative diathesis, dermal depigmentation.

(See Reference No. 48.)

FISH DISEASES - Types, Causes and Remedies

References Reviewed

1. Post, George, "A review of advances in the study of diseases of fish: 1954-64." *The Progressive Fish-Culturist*, 27(1):3-12. January, 1965.
2. Wood, James W., "Diseases of Pacific salmon: their prevention and treatment." Washington Department of Fisheries, Hatchery Division, Olympia, Washington. June, 1968, 1974.
3. Allison, Leonard N., "Beggar-ticks cause mortality among fingerling coho salmon." *The Progressive Fish-Culturist*, 29(2):113. April, 1967.
4. Amend, Donald F., J.L. Fryer, and K.S. Pilcher, "Production trials utilizing sulfonamide drugs for the control of 'cold-water' disease in juvenile coho salmon." Oregon Fish Commission, Research briefs, 11(1):14-17. June, 1965.
5. Reimers, Paul E., and Carl E. Bond, "Occurrence of the *Bidens* (SP) Achene in the snout of Chinook salmon and reidside shiners." *The Progressive Fish-Culturist*, 28(1):62. January, 1966.
6. Robins, G. Lewis, "The effect of columnaris in mature sockeye and pink salmon the the viability of their eggs and sperm." *The Progressive Fish-Culturist*, 26(4):186-187. October, 1964.
7. Rucker, Robert R., Warren G. Taylor, and Donald P. Toney, "Formalin in the hatchery." *The Progressive Fish-Culturist*, 25(4):203-207. October, 1963.
8. Sova, Carl R., "Agri-mycin 100 as a control for fin rot in fishes." *The Progressive Fish-Culturist*, 25(3):120. April, 1963.
9. Bullock, Graham L., "A new medium for isolation and presumptive identification of *Aeromonas salmonicida*." *The Progressive Fish-Culturist*, 24(4):184. October, 1962.
10. Bullock, Graham L., "Simple enrichment of commercial media for growth of *Hemophilus Piscium*." *The Progressive Fish-Culturist*, 27(3):163-164. July, 1965.
11. Conrad, John F., and Mark Decew, "First report of *ceratomyxa* in juvenile salmonids in Oregon." *The Progressive Fish Culturist*, 28(4):238. October, 1966.
12. Combs, Bobby D., "An electrical grid for controlling trematode cercariae in hatchery water supplies." *The Progressive Fish-Culturist*, 30(2):67-75. April, 1968.
13. Dumas, Richard F., "Observations on yolk sac constriction in landlocked Atlantic salmon fry." *The Progressive Fish-Culturist*, 28(2):73-75. April, 1966.
14. Earp, Brian John, "Kidney diseases in young salmon." M.S. thesis. University of Washington, Seattle. 1950.
15. Ehlinger, Neil F., "Kidney disease in lake trout complicated by Lymphosarcoma." *The Progressive Fish-Culturist*, 25(1):3-7. January, 1963.
16. Hoffman, Glenn L., Clarence E. Dunbar, and Arthur Bradford, "Whirling disease of trouts caused by *myxosoma cerebralis* in the United States." U.S. Fish and Wildlife, Special Scientific Report - Fisheries, no. 427. June, 1962.
17. Kincheloe, John W., "The effect of the disinfectant additive (antigermin 77) in Pfizer poultry formula terramycin on three species of salmonids." *The Progressive Fish-Culturist*, 25(1):40-41. January, 1963.
18. McElwain, Ivan B., and George Post, "Efficacy of cyzine for trout hexamitiasis." *The Progressive Fish-Culturist*, 30(2):84-91. April, 1968.
19. Parisot, Thomas J., and John Pelnar, "An interim report on Sacramento River Chinook disease: a virus-like disease of Chinook salmon." *The Progressive Fish-Culturist*, 24(2):51-55. April, 1962.
20. Post, George, "Furazolidone (nf-180) for control of furunculosis in trout." *The Progressive Fish-Culturist*, 24(4):182-184. October, 1962.
21. Post, George, and Robert E. Keiss, "Further laboratory studies on the use of furazolidone for the control of furunculosis of trout." *The Progressive Fish-Culturist*, 24(1):16-21. January, 1962.
22. Post, George, and Milton M. Beck, "Toxicity, tissue residue and efficacy of enheptin given orally to rainbow trout for hexamitiasis." *The Progressive Fish-Culturist*, 28(2):83-88. April, 1966.
23. Rabb, L., J.W. Cornick, and L.A. McDermott, "A macroscopic-slide agglutination test for the presumptive diagnosis of furunculosis in fish." *The Progressive Fish-Culturist* 26(3):118-120. July, 1964.
24. Ross, A.J., and H.E. Johnson, "Studies of transmission of mycobacterial infections in Chinook salmon." *The Progressive Fish-Culturist*, 24(4):147-149. October, 1962.
25. Uzmann, J.R., and J.W. Jesse, "The Hexamita (= octomitus) problem: a preliminary report." *The Progressive Fish-Culturist*, 25(3):141-143. July, 1963.
26. Warren, James W., "Kidney disease of salmonid fishes and the analysis of hatchery waters." *The Progressive Fish-Culturist*, 25(3):121-131. April, 1963.
27. Wolf, Ken, C.E. Dunbar, and S.F. Snieszko, "Infectious pancreatic necrosis of trout--a tissue-culture study." *The Progressive Fish-Culturist*, 22(2):64-68. April, 1960.
28. Wood, James Wilford, "Tuberculosis in Pacific salmon and steelhead trout." M.S. thesis. University of Washington, Seattle. 1958.

FISH DISEASES - Types, Causes and Remedies

References Reviewed (Continued)

29. Boyce, Norbert P.J., "Parasite fauna of pink salmon (*Oncorhynchus gorbuscha*) of the Bella Coola River, Central British Columbia, during their early sealife." Fisheries Research Board of Canada, Journal, 26(4):813-820. April, 1969.
30. Knittel, M.D., "Topical application of malachite green for control of common fungus infections in adult spring Chinook salmon." The Progressive Fish-Culturist, 28(1):51-53. January, 1966.
31. Davis, H.S., "Care and diseases of trout." U.S. Fish and Wildlife Service, Research report no. 12. Washington, D.C. revised edition. 1946.
32. Leitritz, Earl, "Trout and salmon culture (hatchery methods)." California Department of Fish and Game, Fish bulletin no. 107. Sacramento, California. 1959.
33. Snieszko, S.F., and Ken Wolf, "Infectious pancreatic necrosis of salmonid fishes (*acute catarrhal enteritis*)." U.S. Fish and Wildlife Service, Fishery leaflet no. 453. Washington, D.C. July, 1958.
34. Wolf, Ken, "Virus disease of sockeye salmon." U.S. Fish and Wildlife Service, Fishery leaflet no. 454. Washington, D.C. July, 1958.
35. Wolf, Ken, "Blue-sac disease of fish (also known as dropsy, yolk sac disease and *hydrocoele embryonalis*)." U.S. Fish and Wildlife Service, Fishery leaflet no. 455. Revised edition. Washington, D.C. May, 1963.
36. Wolf, Ken, "White-spot disease of fish eggs and fry." U.S. Fish and Wildlife Service, Fishery leaflet no. 456. Revised edition. Washington, D.C. August, 1962.
37. Wolf, Ken, "Soft-egg disease of fishes." U.S. Fish and Wildlife, Fishery leaflet no. 457. Washington, D.C. July, 1958.
38. Wolf, Ken, "Lymphocystis disease of fish." U.S. Fish and Wildlife Service, Fishery leaflet no. 458. Washington, D.C. July, 1958. Revised as Fishery leaflet no. 565. January, 1964.
39. Snieszko, S.F., "Freshwater fish diseases caused by bacteria belonging to the genera *Aeromonas* and *Pseudomonas*." U.S. Fish and Wildlife Service, Fishery leaflet no. 459. Washington, D.C. July, 1958.
40. Wolf, Ken, "Fungus or saprolegnia infestation of incubating fish eggs." U.S. Fish and Wildlife Service, Fishery leaflet no. 460. Washington, D.C. July, 1958.
41. Snieszko, S.F., "Columnaris disease of fishes." U.S. Fish and Wildlife Service, Fishery leaflet no. 461. Washington, D.C. July, 1958.
42. Snieszko, S.F., "Fin rot and peduncle disease of salmonid fishes." U.S. Fish and Wildlife Service, Fishery leaflet no. 462. Washington, D.C. July, 1958.
43. Snieszko, S.F., "Nutritional (dietary) gill disease and other less known gill diseases of fresh-water fishes." U.S. Fish and Wildlife Service, Fishery leaflet no. 463. Washington, D.C. July, 1958.
44. Snieszko, S.F., "Bacterial gill disease of fresh-water fishes." U.S. Fish and Wildlife Service, Fishery leaflet no. 464. Washington, D.C. July, 1958.
45. Piper, Robert G., "Ulcer disease in trout." U.S. Fish and Wildlife Service, Fishery leaflet no. 466. Washington, D.C. July, 1958.
46. Snieszko, S.F., "Fish furunculosis." U.S. Fish and Wildlife Service, Fishery leaflet no. 467. Washington, D.C. July, 1958.
47. Wolf, Ken, "Bacterial kidney disease of salmonid fishes." U.S. Fish and Wildlife Service, Fishery leaflet no. 566, (Fish disease leaflet no. 8). A revision of Fishery leaflet no. 465. Washington, D.C. October, 1966.
48. United Nations Development Programme, Food and Agriculture Organization. Aquaculture Development and Coordination Program, Inland Aquaculture Engineering - Lectures presented at the ADCP Inter-regional Training Course in Inland Aquaculture Engineering. Budapest, 6 June - 3 September 1983. (Table 6 from Chapter 17, Artificial Feeding in Intensive Fish Culture.)
49. Mulcahy, D., and R.J. Pascho, "Vertical transmission of infectious haematopoietic necrosis virus in sockeye salmon, *Oncorhynchus nerka* (Walbaum): isolation of virus from dead eggs and fry." U.S. Fish and Wildlife Service, National Fishery Research Center, Seattle, Washington. 1985.
50. Mulcahy, D., R. Pascho, and C.K. Jenes, "Comparison of *in vitro* growth characteristics of ten isolates of infectious haematopoietic necrosis virus." U.S. Fish and Wildlife Service, National Fishery Research Center, Seattle, Washington. 1984.
51. Burke, J., and D. Mulcahy, "Retention of infectious haematopoietic necrosis virus infectivity in fish tissue homogenates and fluids stored at three temperatures." U.S. Fish and Wildlife Service, National Fishery Research Center, Seattle, Washington. 1983.
52. Mulcahy, Dan, John Burke, Ron Pascho, and C.K. Jenes, "pathogenesis of infectious hematopoietic necrosis virus in adult sockeye salmon (*Oncorhynchus nerka*)." U.S. Fish and Wildlife Service, National Fishery Research Center, Seattle, Washington. 1981.
53. Mulcahy, Dan, Ron Pascho, and C.K. Jenes, "Mortality due to infectious hematopoietic necrosis of sockeye salmon (*Oncorhynchus nerka*) fry in streamside egg incubation boxes." U.S. Fish and Wildlife Service, National Fishery Research Center, Seattle, Washington. 1983.
54. Mulcahy, D., R.J. Pascho, and C.K. Jenes, "Detection of infectious haematopoietic necrosis virus in river water and demonstration of water-borne transmission." U.S. Fish and Wildlife Service, National Fishery Research Center, Seattle, Washington. 1983.

FISH DISEASES - Types, Causes and Remedies

References Reviewed (Continued)

55. Mulcahy, D., R.J. Pascho, and C.K. Jenes, "Titre distribution patterns of infectious haematopoietic necrosis virus in ovarian fluids of hatchery and feral salmon populations." Short Communication. U.S. Fish and Wildlife Service, National Fishery Research Center, Seattle, Washington. 1983.
56. Mulcahy, D., and K. Bauersfeld, "Effect of loading density of sockeye salmon, *Oncorhynchus nerka*, (Walbaum), eggs in incubation boxes on mortality caused by infectious haematopoietic necrosis." Short Communication. U.S. Fish and Wildlife Service, National Fishery Research Center, Seattle, Washington and Washington Department of Fisheries, Olympia, Washington. 1983.

Chapter 22

Use of Anesthetics and Tranquilizer Drugs in Fisheries Work

Table 1. Commonly Used Anesthetics for Fish. Describes commonly used anesthetics for fish and includes preferred use, concentration, time required for anesthesia and recovery, and water solubility.

Table 2. Use of M.S. 222 With Selected Species of Fish. Describes use of M.S. 222 with selected species of fish and shows its stability, effect and toxicity to man.

References Reviewed.

USE of ANESTHETICS and TRANQUILIZER DRUGS in FISHERIES WORK

Those drugs in most common use are shown in the table on pages 22.2-3, which includes notations on their effects. As noted, some have a wide range of application and others are particularly adaptable to special uses.

The time factor, both for general anesthesia and for tranquilizers, varies widely with water temperature, water quality and size of fish, and also exhibits variation between some species. Examples of this variation for various drugs are shown in the table on pages 22.2-3, and for a specific drug, M.S. 222, in the table on page 22.4, taken directly from the publication, "M.S.222 - Sandoz, the anesthetic of choice in work with cold-blooded animals." Technical Bulletin of Sandoz Pharmaceuticals, Hanover, N.J.

Certain drugs, such as sodium amytal, are not effective in sea-water or highly alkaline water; further, the effects of some drugs on fish are not known or recorded. Test trials always should be conducted within the listed range of concentration before large scale use. Research and field trials may reveal drugs that are equal or superior to those listed.

Many of the drugs listed are known by several names, of which only the most common are given. Those that are narcotics or hypnotics may not be obtained easily. All should be used with proper care to prevent irritation or more serious effects on humans in contact with the drugs. One that was formerly used widely, urethane, is omitted because of possible carcinogenic effects. Continuous checks should be kept on all for possible side effects.

Most of the data contained on pages 22.2-3 is presented in greater detail in Bulletin No. 148 of the Fisheries Research

Board of Canada, 1964 (Revised 1967) by Gordon R. Bell, "A guide to the properties, characteristics and uses of some general anesthetics for fish."

More specific details on types of drugs and certain of their effects may be obtained from the reference:

Subject	Reference No.
Types	1 - 28
Doses by species	10, 29 - 42, 45, 46
Doses - Concentration	1, 7, 14, 16, 18, 25, 26, 33 - 35, 42, 47
Doses - Duration	1, 14, 26, 34, 36
Uses - Hatcheries	34, 47, 48
Uses - Transportation	9, 11, 12, 14, 16, 24, 42, 49 - 59
Uses - Tagging and marking	60 - 61
Effects on humans	1, 18
Preference	1, 8, 15, 16, 18, 24, 31, 35, 42, 47
Recovery time	1, 11, 13, 27, 34, 42
Side effects	1, 18, 20, 25, 33, 47

Also see Chapter 19, "Hatcheries," and Chapter 30, "Transportation," for uses of anesthetics and tranquilizer drugs.

A wide range of satisfactory concentration vs. anesthesia duration has been reported, but an average ratio for 5- to 10-inch specimens at a temperature of from 40 F. to 60 F. is shown on page 22.4.

USE of ANESTHETICS and TRANQUILIZER DRUGS in FISHERIES WORK

Table 1

Commonly Used Anesthetics for Fish

Common Name	Preferred Use	Concentration	Time Required (Min.) for		Solubility in water Gal./100/m.
			Anesthesia	Recovery	
M.S. 222 (solid) (Tricaine methanesulfonate)	Marking, tagging, spawn taking, operations, transportaion	0.5-1.0 g./gal.	2-4	3-5	Very soluble
		0.14 g./gal.	Tranquilizer		
Chloretone (crystal) (Chlorbutanol)	Marking, tagging	1.5 g./gal.	1-2	3-5	0.8; mix stock solution with warm water
Quinaldine (liquid)	Marking, tagging	5-12 p.p.m.	1-6	1-10	Slight; mix stock solution with acetone or ethanol
Methyl pentynol (liquid)	Transportation	2l-4 ml./gal.	Tranquilizer	Immediate in F.W.	Density 0.87, will float unless mixed
Sodium amytal (solid) (Amobarbital sodium)	Transportation in soft water	0.5-0.8 g./gal.	Tranquilizer, slow acting-15-30	Immediate in F.W.	Very soluble
Tert.-amyl alcohol (liquid) (Amylene hydrate)	Marking, tagging, transportation	5-6 ml./gal. 1-2 ml./gal.	8-12	20-30	Density 0.81 14 ³⁰
Tribromoethanol (solid)	Short-term experiments	5-50 p.p.m.	Varies	Varies	Mix with ethanol, ether or amyene hydrate 2.5 ⁴⁰
Phenoxyethanol (liquid) (Phenoxethol)	Marking, tagging, general anesthesia	0.5-1.5 ml./gal.	2-5	3-10	Mix stock solution with warm water or ethanol 2.67 ²⁵
Chloral hydrate (solid)	Short-term anesthesia	9.5-14 g./Imp. gal.	2-3	--	21 ¹⁷
Ether (liquid) (Ethyl oxide)	Short-term anesthesia	1/oz./gal.	1-2	3-20	7.5 ²⁰ Density 0.71 Mix thoroughly
Thiouracil (solid)	Transportation	388 p.p.m.	Several hours	Slow	Soluble, dissolve in warm water
Propoxate (solid)	Transportation, marking, tagging	2-4 p.p.m. for anesthesia near salmon; 1/4 p.p.m. or less for transport	2-3	5-9	Very soluble
4 SP (solid) (4-Styrylpyridine)	Marking, tagging	20-50 p.p.m.	12-25	6-8	Slight; dissolve in acetone

USE of ANESTHETICS and TRANQUILIZER DRUGS in FISHERIES WORK

Commonly Used Anesthetics for Fish (Continued)

Stability		Effect	Toxicity to Man	Remarks
Undiluted	Solution			
Stable	Loses strength slowly	Decreases activity and O ₂ consumption	Slight	Produces rapid deep anesthesia. Avoid contact with sperm, as it retards motility and causes poor egg fertilization. Best for operations. Limited use in transportation because unstable in dilute solution.
Sublimes Keep tightly closed	Fairly stable	Depressant; relaxes involuntary muscles	Irritant	Effective rate increases rapidly with temperature.
Fair, keep tightly closed	Several days	Unknown; may be depressant	Slight	Good lethal tolerance range.
Stable	Stable	Decreases activity and O ₂ consumption	Slight	Excellent aid in transportation. Causes excess foaming in aerated solution unless used with 1% Dow Corning Anti-Foam AF or similar antifoam agent.
Stable	Loses strength slowly	Sedation; reduces O ₂ consumption	Normally non-toxic	Not effective in seawater or hard water. A habit forming soporific and narcotic. Not a good general anesthetic. Not effective about 50 F.
Stable	Stable	Depressant; reduces O ₂ consumption	Irritant	Long induction and recovery period. Some hyperactivity during recovery. Causes excess foaming in aerated solution unless used with antifoam agent.
Slowly decomposes	Decomposes in water	Depressant	Strong irritant	High narcotic potency, but unstable. Limited use.
Stable	Stable	--	--	Effective dose for deep anesthesia lethal level. Fish may be hyperactive during induction and recovery.
Slowly volatilizes	Decomposes slowly	Depressant	Irritant	Habit forming; hypnotic. Protect solution from light and heat.
Good, but volatile	Good, but evaporates readily	Narcotic to central nervous system	Irritant	Very flammable and explosive in air. Use only in well-ventilated area. Extremely volatile. Limited use. Cheap and readily available, but others more suitable for fish.
Stable	Stable	Reduces metabolism; O ₂ consumption reduced 20%	--	Slow acting; other drugs more effective.
Stable	Good; can re-use	Sedative; reduces metabolism	Unknown; should be non-irritating	Not yet commercially available; Belgium import; unduly expensive.
Stable	Good; can re-use	Deep anesthesia; reduces respiration and heart action	Non-irritating; safe to handle	Mix well to avoid precipitation; low water solubility could be disadvantage.

USE of ANESTHETICS and TRANQUILIZER DRUGS in FISHERIES WORK

Table 2
Use of M.S. 222 with Selected Species of Fish

Variety of Fish	Concentration of M.S. 222	Anesthesia Time	Remarks
1. Silver Salmon (fingerlings 3 to 5 inches)	1:3,785	2-4 min. 36 F.	Fin clipping. Some mortality longer than 4 minutes. None at 2 minutes. (Mortality 37 out of 11,922.)
2. <i>Lebistes reticulatus</i>	1:5,000	5 min.	Longer anesthesia likely to kill fish, but repetition at intervals 3-5 days possible without injury.
3. Sockeye Salmon (immature)	1:12,000	4-5 min.	Experiment for weight, length and scale data. No adverse effects.
4. Salmon	1:12,500	15-30 min. to 2 hrs.	Marking--no adverse effects.
5. Salmon (fingerlings)	1:17,000 to 17,500	10 min.	Fin marking experiment. No adverse effect. Little difference in time to anesthetize different fish.
6. Rainbow Trout	1:3,333	30 sec.	Mortality over 40-50 seconds.
7. Lake Trout (8-20")	1:13,100	30 min.	Generally, no adverse effect, but if temperature increased to 80 F. mortality occurred.
Bluegills (3-7")	1:3,333	5 min.	
8. Lake Trout (<i>C. namaycush</i>)	1:12,500	5-15 min.	Larger fish took longer time to feel effects of drug. No adverse effect.
9. Steelhead Rainbow Trout (yearlings)	1:15,140	5 min.	Fin clipping. No loss and no adverse effect using several hundred thousand. Fish regained their senses very rapidly upon being placed in fresh water.
10. Rainbow Trout King Salmon	1:15,000 1:20,000 1:25,000	5-20 min.	Spawning--No adverse effect.
11. Rainbow Trout (Fall and Spring Spawn)	1:3,785 1:11,625	1-2 min. 1-2 min.	Subcutaneous tagging. If temperature above 60 F. at 1:3,785 mortality occurred, but did not occur if concentration was 1:11,625. Reported as superior to Urethane for subcutaneous tagging.
12. Brown and Rainbow Trout	1:5,530 1:12,500	18-20 min.	Spawning--no adverse effect.
13. Large Mouth Bass	1:3,000	1-3 min.	Weighing and measuring experiment. No adverse effect. Found M.S. 222 very satisfactory.
14. Rainbow and Brook Trout, Bass, Bluegills	1:3,785 for experiment, 1:38,750 for transportation	to 13 hrs.	No adverse effect when exposed for a short time. Reported as excellent for spawning, fin clipping, tagging experiment. Used in transportation as long as 8 hrs at 1:38,750. Promising but conflicting results during transportation.
15. Tropical and Goldfish, Bluegills, Bullheads	1:3,500	4-10 min.	No adverse effect, even when used repeatedly tri-weekly over several months on same animals. Longer time reported to anesthetize larger goldfish. Most observation at a temperature of 68 F. + 3 F.
16. Rainbow Trout, Brook Trout, Large Mouth Bass	1:15,500 1:31,000	20 min.	Tagging and fin clipping 10% mortality on one strain of rainbow trout. Between amount of M.S. 222 and size of animal--direct relation.

USE of ANESTHETICS and TRANQUILIZER DRUGS in FISHERIES WORK

References Reviewed

1. Bell, Gordon, "A guide to the properties, characteristics and uses of some general anesthetics for fish." Fisheries Research Board of Canada, Bulletin no. 148. Ottawa, Canada, revised edition. 1967.
2. "M.S. 222 - Sandoz, the anesthetic of choice in work with cold-blooded animals." Sandoz Pharmaceuticals, Technical Bulletin, Hanover, N.J. 1959.
3. Fish, F.F., "The anesthesia of fish by high carbon dioxide concentration." Transaction of the American Fisheries Society, 72:25-29. 1943.
4. Witjens, P.H., C.P. Van Dyk, and P. Verkade, "Investigations of the usefulness of the goldfish test for determination of local anesthetic activity." Archives internationales de pharmacodynamie et de therapie, 74(3-4):378-398. June 15, 1947.
5. Skinner, John E., "Methyl pentynol." Correspondence from H.B. Holmes. April 15, 1954.
6. Parkhurst, Zell E., "Progress report--use of various drugs as aids in spawn-taking." Unpublished correspondence received from H.B. Holmes, April 15, 1954.
7. Webb, Robert T., "Distribution of bluegill treated with tricaine methanesulfonate (M.S. 222)." The Progressive Fish-Culturist, 20(1):69-72. April, 1958.
8. Nakatani, R.E., "A method for force-feeding radioisotopes to yearling trout." The Progressive Fish-Culturist, 24(2):56-59. April, 1962.
9. Sheridan, W.L., and Charles Weir, "Tank for air transport of fish." The Progressive Fish-Culturist, 24(3):111. July, 1962.
10. "Susquehanna fishing study--progress report." Correspondence received from H.B. Holmes, July 1, 1959.
11. Dollar, Alexander M., "Air transportation of living rainbow trout." The Progressive Fish-Culturist, 25(3):167-168. July, 1963.
12. Thompson, R.B., "Tricaine methanesulfonate (M.S. 222) in transport of cutthroat trout." The Progressive Fish-Culturist, 21(1):96. April, 1959.
13. Crawford, Bruce, and Andrew Hulsey, "Effects of M.S. 222 on the spawning of channel catfish." The Progressive Fish-Culturist, 25(4):214-215. October, 1963.
14. Martin, N.V., and D.C. Scott, "Use of tricaine methanesulfonate (M.S. 222) in the transport of live fish without water." The Progressive Fish-Culturist, 21(4):183-184. October, 1959.
15. Blanchard, J.H., "Preliminary report - the use of tranquilizers as a possible sampling tool." Southeastern Association of Game and Fish Commissioners, 19th annual conference, Proceedings pp. 394-396. Tulsa, Oklahoma. October 10-13, 1965.
16. McFarland, William N., "The use of anesthetics for the handling and the transport of fishes." California Fish and Game, 46(4):407-431. October, 1960.
17. Lewis, William M., "Isobornyl thiocyanacetate as a fish drugging agent and selective toxin." The Progressive Fish-Culturist, 30(1):29-31. January, 1968.
18. Toth, Robert, "Fish anesthetics." In "Inland Fisheries Management," edited by Alex Calhoun, California Department of Fish and Game, pp. 148-149. Sacramento, California. 1966.
19. Sorenson, Leroy, Keen Buss, and Arthur D. Bradford, "The artificial propagation of esocid fishes in Pennsylvania." The Progressive Fish-Culturist, 28(3):133-141. July, 1966.
20. Allison, Leonard N., "The effect of tricaine methanesulfonate (M.S. 222) on the motility of brook trout sperm." The Progressive Fish-Culturist, 23(1):46-47. January, 1961.
21. Stevens, Robert E., "Hormone-induced spawning of striped bass for reservoir stocking." The Progressive Fish-Culturist, 28(1):19-28. January, 1966.
22. Fry, F.E.J., and K.S. Norris, "The transportation of live fish," in "Fish and food," edited by Georg Borgstrom, vol II, pp. 595-608. Academic Press. New York. 1962.
23. Gibson, R.N., "The use of the anesthetic quinaldine in fish ecology." Journal of Animal Ecology, 36(2):295-301. June, 1967.
24. Norris, Kenneth S., Frank Borcato, Frank Calandrino, and William N. McFarland, "A survey of fish transportation methods and equipment." California Fish and Game, 46(1):23-24. January, 1960.
25. McFarland, William N., "A study of the effects of anesthetics on the behavior and physiology of fishes." Institute of Marine Science, University of Texas, 6:23-55. Port Arkansas, Texas. 1959.
26. Muench, Bruce, "Quinaldine, a new anesthetic for fish." The Progressive Fish-Culturist, 20(1):42-44. January, 1959.
27. Marking, Leif L., "Toxicity of MS-222 to selected fishes." U.S. Bureau of Sports Fisheries and Wildlife, Investigations in fish control no. 12 (Resource publication no. 18). January, 1967.
28. Schoettger, Richard A., "Annotated bibliography on M.S.-222." U.S. Bureau of Sports Fisheries and Wildlife, Investigations in fish control no. 16 (Resource publication no. 22). January, 1967.
29. Gilbert, P.W., and F.G. Wood, "Method of anesthetizing large sharks and rays safely and rapidly." Science, 126(3266):212-213. August 2, 1957.
30. Eisler, Ronald, and Tadeus Backiel, "Narcotization of chinook salmon fingerlings with tricaine methanesulfonate (M.S. 222)." Transactions of the American Fisheries Society, 89(2):164-167. April, 1960.

USE of ANESTHETICS and TRANQUILIZER DRUGS in FISHERIES WORK

References Reviewed (Continued)

31. Meister, Alfred L., and Charles F. Ritzi, "Effects of chloretone and M.S. 222 on eastern brook trout." *The Progressive Fish-Culturist*, 20(3):104-110. July, 1958.
32. Meehan, William R., and L. Revet, "The effect of tricaine methanesulfonate (M.S. 222) and/or chilled water on oxygen consumption of sockeye salmon fry." *The Progressive Fish-Culturist*, 24(4):185-187. October, 1962.
33. Smith, L.S., and G.R. Bell, "Anesthetic and surgical techniques for Pacific salmon." *Fisheries Research Board of Canada, Journal*, 24(7):1759-1588. July, 1967.
34. Sakano, Ei-ichi, "Anesthetizing experiments of chum salmon fry with tricaine methanesulfonate (M.S. 222)." *Japan. Hokkaido Salmon Hatchery, Scientific reports no. 16:103-106.* November, 1961.
35. Parkhurst, Z.E., and M.A. Smith, "Various drugs as aids in spawning rainbow trout." *The Progressive Fish-Culturist*, 19(1):39. January, 1957.
36. Sehdev, H.S., J.R. McBride, and U.H.M. Fagerlund, "2-Phenoxyethanol as a general anesthetic for sockeye salmon." *Fisheries Research Board of Canada, Journal*, 20(6):1435-1440. November, 1953.
37. Hanson, Harry A., "Tranquilizing formula of quinaldine and M.S. 222 for salmon and steelhead." Unpublished correspondence to Harlan B. Holmes from the California Department of Fish and Game.
38. Burrows, R.E., "Chloretone used to anesthetize salmon fingerlings." *The Progressive Fish-Culturist*, 14(2):78. April, 1952.
39. Cope, Oliver B., "Chloretone as an anesthetic for adult cutthroat trout." *The Progressive Fish-Culturist*, 15(1):35. January, 1953.
40. Nelson, P.R., "Use of three anesthetics on juvenile salmon and trout." *The Progressive Fish-Culturist*, 15(2):74. April, 1953.
41. Webb, Robert, "Distribution of bluegill treated with tricaine methanesulfonate (M.S. 222)." *The Progressive Fish-Culturist*, 16(4):182. October, 1954.
42. Rodman, Duane T., "Anesthetizing and air-transporting young white sturgeons." *The Progressive Fish-Culturist*, 25(2):71-78. April, 1963.
43. Walker, Charles R., and Richard A. Schoettger, "Method for determining MS-222 residues in fish." U.S. Bureau of Sports Fisheries and Wildlife, Investigations in fish control no. 14, (Resource publication no. 20). January, 1967.
44. Walker, Charles R., and Richard A. Schoettger, "Residues of MS-222 in four salmonids following anesthesia." U.S. Bureau of Sports Fisheries and Wildlife, Investigations in fish control no. 15. (Resource publication no. 21.) January, 1957.
45. Schoettger, Richard A., and M. Julin Arnold, "Efficacy of M.S.-222 as an anesthetic on four salmonids." U.S. Bureau of Sports Fisheries and Wildlife, Investigations in fish control no. 13, (Resource publication no. 19). January, 1967.
46. Schoettger, Richard A., Charles R. Waler, Leif L. Marking, and Arnold M. Julin, "MS-222 as an anesthetic for channel catfish: its toxicity, efficacy and muscle residues." U.S. Bureau of Sports Fisheries and Wildlife, Investigations in fish control no. 17, (Resource publication no. 33). January, 1967.
47. Leitritz, Earl, "Trout and salmon culture--(hatchery methods)." *California Department of Fish and Game, Fish Bulletin no. 107:112, 134-137.* 1959.
48. Bailey, Merryl M., "Lake trout fin-clipping rates at two national fish hatcheries." *The Progressive Fish-Culturist*, 27(3):169-170. July, 1965.
49. "Report on the use of sodium amytal and second sodium as an aid in the transport of fish." Unpublished correspondence from the California Fish and Game Department.
50. Osborn, P.E., "Some experiments on the use of thiouracil as an aid in holding and transporting fish." *The Progressive Fish-Culturist*, 13:75-78. April, 1951.
51. Cuerrier, J.P., "Transfer of anesthetized adult lake trout by means of aircraft." *Canadian Fish Culturist*, no. 13:1-4. December, 1952.
52. Calhoun, Alex., "Hypnotic drugs as an aid in fish transportation." Unpublished correspondence to Harlan B. Holmes from the California Department of Fish and Game. (Mimeo.) 3 pp., 1953.
53. Reese, A., "Use of hypnotic drugs in transporting trout." *California Department of Fish and Game, Mimeo. Report*, 10 pp. Unpublished. 1953.
54. Skinner, John E., "Use of Dow Corning antifoam A F emulsion to prevent foaming in fish transport tanks." *California Inland Fisheries Branch, Inland Fisheries Administrative Report no. 3; 1-2, (Mimeo) 1955.*
55. Schultz, F.H., "Transfer of anesthetized pike and yellow walleye." *Canadian Fish Culturist*, no. 18: 1-5. March, 1956.
56. Nemoto, C.M., "Experiments with methods for air transport of live fish." *The Progressive Fish-Culturist*, 19(4):147-157. October, 1957.
57. McFarland, W.N., "A study of general anesthetics in teleosts with a discussion of its implications to the transportation of fishes." Ph.D thesis, University of California, Los Angeles, 1959.
58. Collins, James L., and Andrew H. Hulsey, "Hauling mortality of threadfin shad reduced with M.S. 222 and salt." *The Progressive Fish-Culturist*, 25(2):105-106. April, 1963.

USE of ANESTHETICS and TRANQUILIZER DRUGS in FISHERIES WORK

References Reviewed (Continued)

59. Gebhards, Stacy V., "Transport of juvenile trout in sealed containers." *The Progressive Fish-Culturist*, 27(1):31-41. January, 1965.
60. Foster, R.F., "Marking trout under anesthetics..." *The Progressive Fish-Culturist*, no. 54:30-31. August, 1941.
61. Eschmeyer, P.H., "The effect of anesthesia on fin-clipping rate." *The Progressive Fish-Culturist*, 15(2):80-82. April, 1953.
62. Taylor, A.L., and D.J. Solomon, "Critical factors in the transport of live freshwater fish: III. The use of anesthetics as tranquilizers." *Fish Mgmt.*, 10(4). Salmon and Freshwater Fisheries Laboratory, Ministry of Agriculture, Fisheries and Food. London. 1979.

Chapter 23

Fish Pumps

Special pumps for transferring juveniles.

Avoid supersaturation of oxygen or nitrogen in ponds or tanks.

Two types of kill may occur: strike (shear) and air bubble disease.

Venturi action should be avoided.

Runner speed should be less than 18.8 fps.

References Reviewed.

FISH PUMPS

Special pumps have been developed for use in transferring juvenile fish from ponds or tanks to other ponds or tanks. There are a number produced commercially. Pumps provide a convenient way of transporting small fish with losses of less than 10 per cent.

Most fish ponds and tanks are less than 4 feet deep, which can add approximately 1.74 pounds to the atmospheric pressure to which the fish must adjust for neutral buoyancy.

In general, there should not be supersaturation of oxygen or nitrogen in the ponds or tanks. If present, its effect must be considered when lower pressures are created to move the fish from levels below the centerline of the pump.

Two types of kill may occur in pumping operations: runner or jet strike (shear), and the rupture of the swim bladder or air bubble disease caused by lowered pressure. All ventura action should be avoided.

To prevent losses, the runner speed should be less than 18.8 fps. As an example:

$$\frac{(\text{RPM})(\text{runner diameter in feet})(\pi)}{60 \text{ seconds}} = \text{runner speed in fps}$$

The velocity of the jet at the contact point with the moving fish should not be greater than 30 fps.

Discharge jet velocities in feet per second can be deter-

mined by the area of the jet's orifice and known volume of water introduced. As an example:

$$\bar{V} \text{ (fps)} = \frac{\text{discharge in cfs}}{\text{area of jet orifice in sq. ft.}}$$

If the jet orifice is given in square inches, divide by 144.

The drop in pressure should not exceed one-half of the atmospheric pressure at the site plus water depth equivalent to pounds per square inch in the suction hose.

As most hatchery-sized rearing ponds are less than 4 feet deep, the effect of pressure is related to atmospheric pressure plus depth pressure.

As an example:

$$\text{atm} + (.434)(4 \text{ ft}) = 16.4 \text{ lbs/square inch}$$

This gives the depth pressure to which a fish must adjust to become neutrally buoyant at 4 feet.

At 8 pounds per square inch absolute pressure, or 6-7 pounds negative gage pressure, the swim bladder would be expanded to about twice its size in depth-accustomed fish in ponds at 4 feet of depth.

See Chapter 25, "Passage of Fish Through Turbines, Spillways and Conduits," for graphic presentation on shear values and pressure changes.

References Reviewed

1. Bedell, Gerald, W., and Phillip D. Flint, "Pumping fish in California." *The Progressive Fish-Culturist*, 31(4):233-235. October, 1969.
2. Burgeon, D.W., "For herring-fish pumps can save time and money." *Western Fisheries*, 56(5):26-32, 50-51. August, 1958.
3. Burgeon, D.W., "The use of fish pumps in the U.S.A." In "Modern Fishing Gear of the World," edited by Hilmar Kristjonsson, Vol. 1:414-417. 1959.
4. Grinstead, Bobby G., "A fish pump as a means of harvesting gizzard shad from tailwaters of TVA reservoirs." *The Progressive Fish-Culturist*, 31(4):236-238. October, 1969.
5. Kerr, James E., "Studies on fish preservation at the Contra Costa steam plant of the Pacific Gas and Electric Company." California Department of Fish and Game, *Fish Bulletin* 92:45-50. 1953.
6. Roach, S.W., F.G. Claggett, and J.S.M. Harrison, "An air-lift pump for elevating salmon, herring and other fish of similar size." *Fisheries Research Board of Canada, Journal*, 21(4):845-849. July, 1964.
7. Summers, F.E., "Fish pumping experiments conducted at Coleman Station Hatchery." Unpublished. Letter and report sent to Milo C. Bell. August 6, 1951.
8. "Tomato pump used to convey fish." *Seattle Times*, January 26, 1970, p. A7, col. 3.
9. Washington Department of Fisheries, "Summary report on the experimental testing of fishing gear for determining the vertical and horizontal distribution of seaward migrants in the forebays of dams." Unpublished report submitted to U.S. Army Corps of Engineers, Contract No. DA 35026-Eng-20571. September, 1954 to September, 1955. pp. 19-22. 1955.
10. Groves, Alan B., "Effects of hydraulic shearing actions on juvenile salmon." National Marine Fisheries Service, National Oceanic and Atmospheric Administration. Summary Report. Seattle, Washington. November, 1972.
11. Robinson, John B., "Effects of passing juvenile king salmon through a pump." *The Progressive Fish-Culturist*, 33(4):219-223. October, 1971.
12. Webb, R.D., "Test of air-life fish pump." Washington State Department of Fisheries, Olympia. Unpublished. April 27, 1967.
13. Bechtel Incorporated, Hydro and Community Facilities Division, "Report on fish pumps." Unpublished. San Francisco. July 23, 1971.
14. Meing, Mike, "Effects of passing juvenile king salmon (*Oncorhynchus tshawytscha*) and American shad (*Alosa sapidissima*) through a single impeller volute pump." California Department of Fish and Game, Bay-Delta Fishery Project, Administrative Report 78-23, 16 pp. 1978.

Chapter 24

Movement of Downstream Migrants

Time of downstream migration.

Factors influencing the downstream migration of salmon and steelhead.

Effects of light intensity.

Migration path of downstream migrants.

Migration rate of downstream migrants.

Diel fluctuation in downstream migration.

Mortality of downstream migrants.

Residualism.

Estuary rearing areas.

References Reviewed.

MOVEMENT OF DOWNSTREAM MIGRANTS

Time of Downstream Migration

The periods of downstream migration are shown in Chapter 5, "Useful Factors in Life History of Most Common Species."

The bulk of the downstream migration of pink salmon fry occurs almost immediately after the yolk sac is absorbed and the fry emerge from the gravel, at which time they are about 1 to 1-1/2 inches in length, 1/4 to 3/10 inch in depth and 3/16 inch in width.

Chum salmon fry also make their downstream migration soon after they emerge from the gravel or, at most, after a brief period of stream rearing. At this time they are approximately 1-1/2 to 2 inches in length.

Silver or coho juveniles spend their first year in fresh water and are usually from 3-1/2 to 4-1/2 inches long at the time of seaward migration. They vary from 5/10 to 9/10 inch in depth and from 1/4 to 1/2 inch in width. In the northerly part of their range, about half of the young remain in fresh water a second year, obtaining extra size.

Although sockeye salmon (blueback in the Columbia) have a lake rearing period from one to four years, in the Columbia and Fraser River systems and Puget Sound most move seaward in their second year at a length of 3-1/2 to 5 inches.

It is difficult to be specific regarding the time of downstream migration of chinook salmon in a river where a number of runs and races are present as the downstream migrants enter the lower section of the river throughout most of the year. In general, the bulk of the seaward migration occurs during the spring and summer months. There have been recent encouraging results from returns of marked migrant fall coho. There are two distinct downstream movements of chinook in the upper Columbia River system: the first, composed of fry in their first year of life, occurs in March and April and the second, composed mainly of fingerlings in their second year, occurs in June and July.

There is great variation in the size of chinook downstream migrants. In general, fall chinook juveniles migrate to the ocean early in the first year of life, usually about 90 days after yolk absorption, at lengths of about 2 to 3 inches. Spring chinook juveniles are expected to remain in fresh water for at least a year before migrating to the ocean in their second spring or later when they are about 3 to 5 inches in length. Sexually mature males are found in fresh water in their second year when as small as 5 inches in length.

The majority of steelhead smolts are two years old when they migrate to salt water. Some migrate in the second spring after hatching, or in their second year of life. Downstream migration of steelhead appears to be more closely associated with size than with age, although it is also associated with spring high water flows. A few steelhead juveniles require three years in fresh water to attain their migratory size of 6 to 8 inches.

Factors Influencing the Downstream Migration of Salmon and Steelhead

Normally, both substantial increases in stream flow and rising water temperatures precede the first significant ex-

pansion in the numbers of downstream migrant fingerlings. For example, in the region of the 49th parallel, fish begin to move downstream at 50 F. This triggering temperature is modified by the average annual temperature regime of a subregion and varies with both latitude and elevation. Visual references and light conditions both affect fish passage at dams and diversions.

In clear, still water silver salmon were attracted to sub-surface lights with intensities in the range of .000025 to .0035 foot candles, whereas at an intensity of 1.3 candles, no attraction occurred. (See Reference No. 37.) In both clear and turbid waters, surface lights with an intensity of .015 foot candles proved to be an effective guiding stimulus (attraction), while a 300 watt light bulb caused repulsion. (See Reference No. 38.) Ten-foot candle lights are effective in stopping fish. Colored lights have no significant effect.

The following gives broad values for comparative uses of foot candles:

Full sunlight	10,000
Full moonlight	0.02
Reading light	10.0
Close work	30-40

One foot candle, which is the light of one candle at 1 foot distance, is equal to 1 lumen per square foot.

Migration Path of Downstream Migrants

The horizontal distribution of downstream migrants may occur across an entire stream, depending on light and water clarity, although usually the area along the shoreline has the larger numbers of fish and, particularly, smaller sized fish.

The vertical distribution generally will show the largest number of downstream migrants in the top half depth, although this is altered by factors such as sunlight, water, temperature, fish size, species and day or night.

Migration Rate of Downstream Migrants

Marking and recovery research projects on chinook downstream migrants at major dams have shown that downstream movement is correlated with water flows, and averages 13 miles per day at low flow discharge and 23 miles per day at moderate river discharge. The migration time through the major impoundments may be three times longer than that for the natural run of the river which may closely approximate the difference in water velocity.

Diel Fluctuation in Downstream Migration

Downstream movement of fingerlings occurs throughout the day with the greatest movement usually occurring during the hours of darkness. Artificial lighting may be a factor in reducing normal hours of total darkness. It has been noted that the daylight movement of downstream migrants is heavier when the water is turbid, although this condition is usually associated with increased flows. Visual references may be a major factor in timing of fish entering openings leading to channels, traps, etc.

Mortality of Downstream Migrants

See Chapter 25, "Passage of Fish Through Turbines, Spillways and Conduits," Chapter 6, "Swimming Speeds

MOVEMENT OF DOWNSTREAM MIGRANTS

of Adult and Juvenile Fish," Chapter 21, "Fish Diseases - Types, Causes and Remedies," and Chapter 10, "Water Quality."

Not all the mortality suffered in the river sections can be attributed to physical injuries incurred in passing the dams. Predation, disease, pollution, residualism, increased water temperature, lack of dissolved oxygen, reduced stream velocity, excess nitrogen and other factors undoubtedly account for varying degrees of loss in the downstream migration.

Avoidance behavior and daily movement particularly contribute to delayed downstream migration and resultant mortality. The relationship of dissolved oxygen and temperature characteristics in reservoirs also contributes to delay. Often, suitable temperatures exist only at depths where oxygen concentrations are unsuitable, and vice versa. This creates barriers which might not exist if only one factor were involved.

Residualism

An unknown portion of the apparent loss of downstream migrating salmonids at dams may in fact be due to residualism in reservoir areas. This is more common with some species, as sockeye, than others. One of the chief factors can be reduced water velocity, resulting in slowed downstream movement and subsequent physiological changes.

Residualism also may increase the extent of predation on juvenile downstream migrants. Many residual fish, both salmon and steelhead, attain a size where they subsist largely on small fish.

Estuary Rearing Areas

Recent research work on juvenile fall chinook salmon in the Columbia River estuary has shown that the extent of natural rearing in the lower river area is a function of size which, in turn, is coordinated with the development of the osmo-regulatory process. The main stem lower Columbia River nursery area was found to be fresh water in the Clatskanie-Mayger area. This area is subject to tidal influence. Juvenile salmon grow rapidly in this area and remain until physiological changes allow them to migrate seaward. Natural rearing of fall chinook was not found to occur in the continually brackish water areas. Salmon that were reared to an unusually large size in a hatchery before release were found to migrate immediately to the ocean without any natural rearing en route.

Estuarial areas are important to pink and chum salmon fry survival as these are their preliminary growth areas. Estuarial areas such as the large delta area of the Sacramento River in California have been found to be extremely important in the growth pattern of chinook salmon and shad. It has also been noted that the velocity of a river entering an estuary or lake has an immediate effect on the dispersal of fry into a receiving area.

MOVEMENT OF DOWNSTREAM MIGRANTS

References Reviewed

1. Burner, C.J., "Vertical distribution of downstream migrating chinook salmon fingerlings in the Bonneville forebay, with a note upon the rate of migration." U.S. Fish and Wildlife Service. Unpublished memorandum of December 16, 1949 to J.T. Barnaby from C.J. Burner.
2. Houston, Arthur H., "Influence of size upon the adaptation of steelhead trout (*Salmo gairdneri*) and chum salmon (*Oncorhynchus keta*) to sea water." Fisheries Research Board of Canada, Journal, 18(3):401-415. May, 1961.
3. Bell, Robert, "Timing of runs of anadromous species of fish and resident fishery studies in the Pleasant Valley-Mountain Sheep section of the middle Snake River." Idaho State Department of Fish and Game, Progress Report. Boise. February, 1957.
4. "A determination of the normal stream distribution, size, current preferences, and time of migration of salmon and steelhead trout in the upper Columbia and Snake Rivers." Washington State Department of Fisheries, unpublished report. November, 1955.
5. Witty, Kenneth, "Travel rate of downstream-migrant coho salmon." The Progressive Fish-Culturist, 28(3):174. July, 1966.
6. "Fall chinook released into Minter Creek, 1954-55." In Washington State Department of Fisheries, "Progress Report," Minter Creek Biological Station, Spring 1955, Part III. Unpublished, Olympia. 1955.
7. Salo, Ernest O., and William H. Bayliff, "Artificial and natural production of silver salmon (*Oncorhynchus kisutch*) at Minter Creek, Washington." Washington State Department of Fisheries, Research Bulletin 4. January, 1958. (Revision of the senior author's Ph.D. thesis.)
8. Phillips, Robert W., "Effect of unusually low discharge from Pelton regulating reservoir, Deschutes River, on fish and other aquatic organisms." Oregon State Game Commission, Basin Investigations Section, Special Report No. 1. Portland. May, 1969.
9. Van Hying, Jack Mattson, "Factors affecting the abundance of fall chinook salmon in the Columbia River." Ph.D. thesis. Oregon State University, Corvallis. pp. 331-350. March, 1968.
10. Major, Richard L., and James L. Mighell, "Egg-to-migrant survival of spring chinook salmon (*Oncorhynchus tshawytscha*) in the Yakima River, Washington." U.S. Fish and Wildlife Service, Fishery Bulletin, 67(2):347-359. June, 1969.
11. U.S. Army Corps of Engineers, North Pacific Division, Fisheries-Engineering Research Program, "Determination of the normal stream distribution, size, time and current preferences of downstream migrating salmon and steelhead trout in the Columbia and Snake Rivers." (Contributed by Washington State Department of Fisheries.) Portland. November, 1956.
12. Raymond, Howard L., "A summary of the 1966 outmigration of juvenile salmonids in the Columbia Basin." Unpublished report. U.S. Bureau of Commercial Fisheries, Fish-Passage Research Program. Seattle, Washington. July, 1967.
13. Hoar, William S., "The behavior of chum, pink and coho salmon in relation to their seaward migration." Fisheries Research Board of Canada, Journal, 8(4):241-263. October, 1951.
14. U.S. Army Corps of Engineers, North Pacific Division, Fisheries-Engineering Research Program, "Determination of the vertical and horizontal distribution of seaward migrants, Baker Dam." (Contributed by Washington State Department of Fisheries.) Portland. November, 1956.
15. Raymond, Howard L., "Freshwater and estuarine research, Columbia River estuary study: operation report, 1 January through 10 April, 1968." U.S. Bureau of Commercial Fisheries. Seattle, Washington. 1968.
16. Anas, Raymond E., and Joseph R. Gauley, "Blueback salmon, *Oncorhynchus nerka*, age and length at seaward migration past Bonneville Dam." U.S. Fish and Wildlife Service, Special Scientific Report--Fisheries No. 185. Washington, D.C. October, 1956.
17. Mains, Edward, M., and John M. Smith, "The distribution, size, time and current preferences of seaward migrant chinook salmon in the Columbia and Snake Rivers." Washington State Department of Fisheries, Fisheries Research papers, 2(3):5-43. March, 1964.
18. Quistorff, Elmer, "Floating salmon smolt collectors at Baker River dams." Washington Department of Fisheries, Fisheries Research Papers, 2(4):39-52. December, 1966.
19. Ellis, C.H., "Tests on hauling as means of reducing downstream migrant salmon mortalities on the Columbia River." Washington State Department of Fisheries, Fisheries Research Papers, 1(4):46-48. March, 1956.
20. "Rainbow trout travels 140 miles in 60 days." California Fish and Game, 16(1):61. January, 1930.
21. Bostick, W.E., "1956 downstream pink evaluation on the Snohomish and Stillaguamish Rivers." In Washington Department of Fisheries, Progress Report, "Puget Sound Stream Studies." Unpublished report by W.E. Bostick, William A. Dunstan, and W.H. Rees, pp. 27-36. Olympia. 1956.
22. Washington Department of Fisheries, "For determining the normal stream distribution, size, time and current preferences of downstream migrating salmon and steelhead trout in the Columbia and Snake Rivers." Unpublished annual report, part III (June 22, 1953 to June 22, 1954) submitted by E.M. Mains, C.E. Stockley, J.M. Smith, and R.T. Pressey to the U.S. Army Corps of Engineers, Contract No. DA 35026-Eng-20571. 1954.

MOVEMENT OF DOWNSTREAM MIGRANTS

References Reviewed (Continued)

23. Williams, I.V., "Implication of water quality and salinity in the survival of Fraser River sockeye smolts." International Pacific Salmon fisheries Commission, Progress Report No. 22. New Westminster, B.C. 1969.
24. Washington Department of Fisheries, "The delay of the 1952 silver salmon escapement." In "White River Studies," Progress report, Puget Sound stream studies, spring and summer, pp. 12-15. Olympia. 1954.
25. Washington Department of Fisheries, "Passage of fish through Mud Mountain Dam." In "White River Studies," Progress Report, Puget Sound stream studies, spring and summer, pp. 9-12. Olympia. 1954.
26. MacKinnon, D., and J.R. Brett, "Some observations on the movement of Pacific salmon fry through a small impounded water basin." Fisheries Research Board of Canada, Journal, 12(3):362-368. May, 1955.
27. Calkins, P., "The effect of fin removal on the swimming ability of young silver salmon." Fisheries Research Institute, Circular 109. College of Fisheries, University of Washington, Seattle. November, 1959.
28. Washington State Department of Fisheries, "Determination of the normal stream distribution, size, time and current preferences of downstream migrating salmon and steelhead trout in the Columbia and Snake Rivers." Final report submitted by E.M. Mains and J.M. Smith to the U.S. Army Corps of Engineers, Contract No. DA 35026-Eng-20571. 1955.
29. Greene, Charles W., "The migration of salmon in the Columbia River." U.S. Bureau of Fisheries, Bulletin, 29:129-148. 1909.
30. Clemens, W.A., R.E. Foerster, and A.L. Pritchard, "The migration of Pacific salmon in British Columbia waters." American Association for the Advancement of Science, Publication No. 8:51-59. 1939.
31. Raymond, Howard L., "Migration rates of yearling chinook salmon in relation to flows and impoundments in the Columbia and Snake Rivers." Transactions of the American Fisheries Society, 97(4):356-359. October, 1968.
32. Canada Department of Fisheries, "Big Qualicum River biological survey, 1960-1961." Vancouver, B.C. September, 1962.
33. McDonald, J.G., "Distribution, growth and survival of sockeye fry (*Oncorhynchus nerka*) produced in natural and artificial stream environments." Fisheries Research Board of Canada, Journal, 26(2):229-267. February, 1969.
34. Massey, Julius B., "The downstream migration of juvenile anadromous fish at Willamette Falls, Oregon." Oregon State Game Commission, Fishery Division, Columbia River Fishery Development Program, Progress report June 1, 1965 through November 30, 1966. Project 912.4-SCR1, Contract No. 14-17-0001-456. Portland. May, 1967.
35. U.S. Army Corps of Engineers, North Pacific Division, "Progress Report on Fisheries-Engineering Research Program." pp. 14-26, contributed by E.M. Mains and J.M. Smith, Washington State Department of Fisheries, "Determination of the normal stream distribution, size, time and current preferences of downstream migrating salmon and steelhead trout in the Columbia and Snake Rivers." Portland. November, 1956.
36. Carney, R.E., and R.J. Adkins, "Reactions of young silver salmon in ten velocity combinations." University of Washington, School of Fisheries, Technical Report 23. August, 1955.
37. Johnson, Donald E., Paul E. Fields, Prabhaker S. Karekar, and Gary L. Finger, "Conditions under which light attracts and repels pre-migratory salmon in clear and turbid, still and running water." University of Washington, College of Fisheries, Technical Report 42. March, 1958.
38. Fields, Paul E., A. Keith Murray, Donald E. Johnson, and Gary L. Finger, "Guiding migrant salmon by light repulsion and attraction in fast and turbid water." University of Washington, College of Fisheries, Technical Reports 36 and 41. February, 1958.
39. CRC Handbook of Chemistry and Physics. 1st Student Edition. Editor-in-Chief, Robert C. Weast, Ph.D. CRC Press, Inc. Boca Raton, Florida. 1988.

Chapter 25

Passage of Fish Through Turbines, Spillways and Conduits

Descent of fish from one level in a river to another.

Man-created stresses absent in normal river gradients.

Temperature effect.

Shock waves that produce negative pressures should be avoided.

Cavitation to be minimized or eliminated.

Large clearances should be provided in vanes of runners of turbines and pumps, between runners and wicket gates.

Open and closed swim bladder fish suffer large kill rates under reduced pressure.

Open swim bladder fish react to reduce pressures rapidly.

Gas embolism a problem in both open and closed swim bladder fish.

Flow nets should be examined.

Retrofitting low head dams requires consideration of type of turbine.

Fish losses in turbines due to collision and pressure changes.

Range of survival resulting from field tests.

Calculated survival results in a single point.

Collision does not kill all fish.

Positive pressures at projects examined not shown to be harmful to fish.

Embolism results from lowered pressure.

Incomplete data a problem in reported field tests.

A. Flow Net at Surface.

B. Fish Lost by Sudden Velocity Deceleration When Striking Water and Solid Objects.

C. Change in Fish Swim Bladder Volume vs. Pressure.

D. Representative Passage Data for Francis, Kaplan and Bulb Turbines. % Survival vs. Head.

References Reviewed.

PASSAGE of FISH THROUGH TURBINES, SPILLWAYS and CONDUITS

Fish descend from one level in a river to another by the following routes: normal stream gradient, falls or rapids in natural streams, spillways of various patterns; turbines of various patterns and sizes; and special by-passes.

In normal river gradients, man-created stresses are absent. Where falls or rapids are of sufficient height to create velocities approaching 40 fps (25 feet of head), potential damage exists. In development projects, shock waves that produce negative pressures should be avoided; cavitation should be minimized or eliminated; venturi action should be avoided; rapid changes of direction, creating possible areas of sudden deceleration or areas of mechanical strike, should be avoided; and large clearances should be provided in the vanes of the runners of turbines and pumps.

It has been noted that when the temperature of the water exceeds 50 F. at latitude 49, fish handling becomes more difficult, and fish brought rapidly from cooler depths to warmer surfaces suffer higher death rates than those that are fully equilibrated to higher temperatures. No time factor has been recorded for the equilibration phenomenon. Flow nets at intakes should be evaluated to determine temperature gradients through which fish will pass. (See Exhibit A.)

Fish with open swim bladders (physostome), to become depth-acustomed, gulp air at the surface, bringing their buoyancy to a level comparable with that of the depth they will inhabit. Fish with counter flow systems, or closed swim bladders (physoclist), are able to extract gases and return them to the water, and by this means adjust to depth. Experimental results indicate that fish with open swim bladders are capable of rapid adjustment of the gas level within the swim bladder, if pressure changes occur in as brief a time as .10 second. Fish capable of gulping air equilibrate at depths and are subject to swim bladder rupture and embolism if brought suddenly to low pressure.

This is a reason for the examination of flow nets and a reason why pressure changes in conduit systems where fish are to be passed, including hatchery plantings by hose, should be thoroughly examined.

The current trend to retrofit existing low head dams with turbines has stimulated interest in the success of passing fish through Francis, Kaplan and bulb turbines.

To aid in the choice of turbines and to provide a general approach to fish passage, methods to obtain answers for passage problems have been prepared and will appear in Reference No. 4.

It is apparent that fish losses in turbines are due to the collision of fish with runner edges and to the extent and location of the low pressure area (approaching zero) that exists between the upper and under faces of the blades or vanes. The mathematical analysis may not be acceptable in licensing, but it gives a method for determining losses.

Results from past field testing for losses in passage through turbines gave a range of losses from which an acceptable average level was chosen and used. The mathematical approach gives a single point, but this technique may be used to show why there is variability in reported losses.

In the discussion of field test data reported, it was appar-

ent to the authors of the reports that not all fish in collision with runners were killed. There was also a number of reported fish killed with no apparent injuries.

Exhibit B shows the effect on fish of collision. Exhibit C shows the effect of suddenly decreased pressure on bladder expansion and kill rate level.

The literature discloses that positive pressure is not harmful to fish at the depths found in reservoirs or head pools.

A latent kill factor exists in the form of embolism, which may form in the fish's fluids under lowered pressure and which, if in a critical body area, causes death.

Reference No. 5 (1987) sums up most of the turbine test data available in the literature. This reference also discloses deficiencies in many of the test series because of incomplete physical data on the turbines and incomplete operating data during the tests described. In some cases, the biological data was incomplete, such as fish species, condition, and lengths and length ranges.

Exhibit D shows the relationship between calculated survival and survival from the field data for representative types of turbines. When complete data are available for operating turbines, calculations of fish passage success are simplified. When needed turbine data are missing, they may be developed in the manner described in Reference No. 4.

Where biological data are incomplete, assumptions must be made. Fish species, condition, and length and length range can be estimated from age, source, and time of year. If temperature data are available, they are helpful in establishing growth and size.

The effect of handling stresses cannot be estimated if the stress is not reported or recognized.

A
Flow Net at Surface

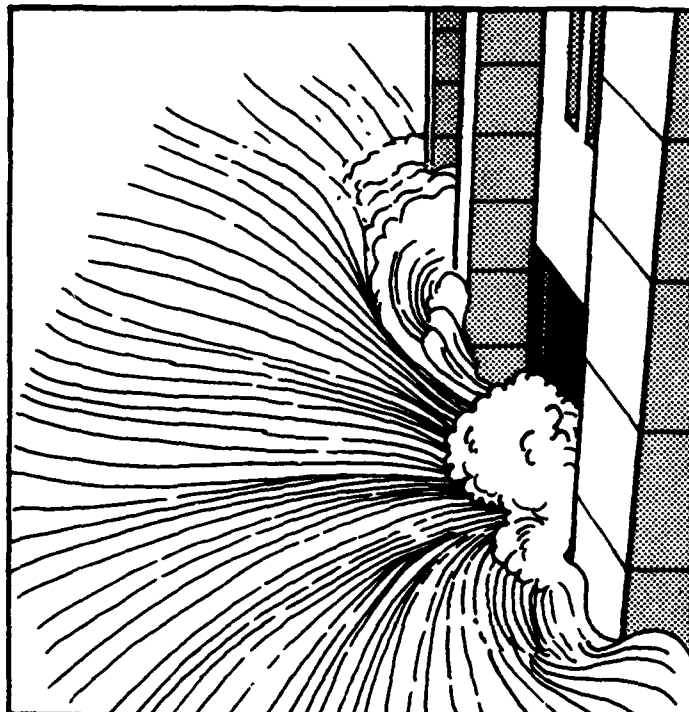

PASSAGE of FISH THROUGH TURBINES, SPILLWAYS and CONDUITS

B Fish Lost by Sudden Velocity Deceleration When Striking Water and Solid Objects

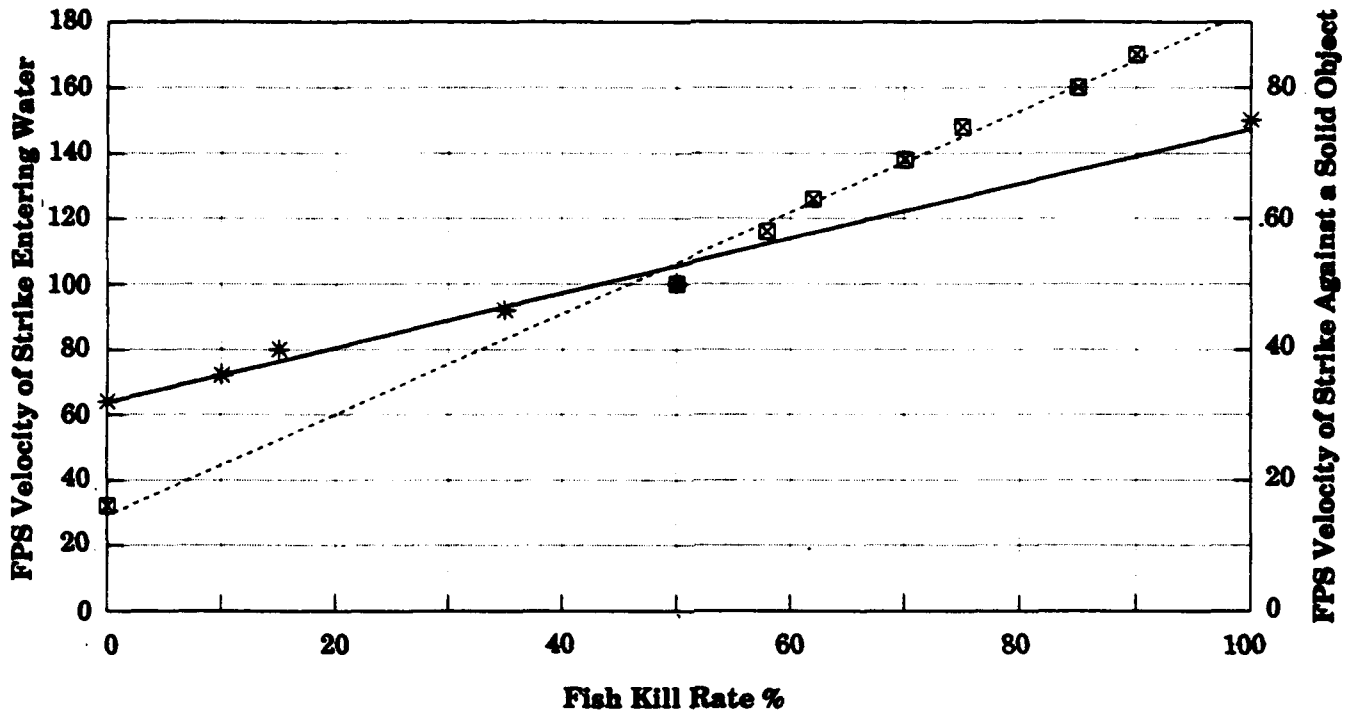

Legend
—*— Entry into water.
--□-- Strike against solid object.

Empirical Data.

PASSAGE of FISH THROUGH TURBINES, SPILLWAYS and CONDUITS

C
Fish Swimbladder Volume Per Unit Weight vs. Absolute Pressure

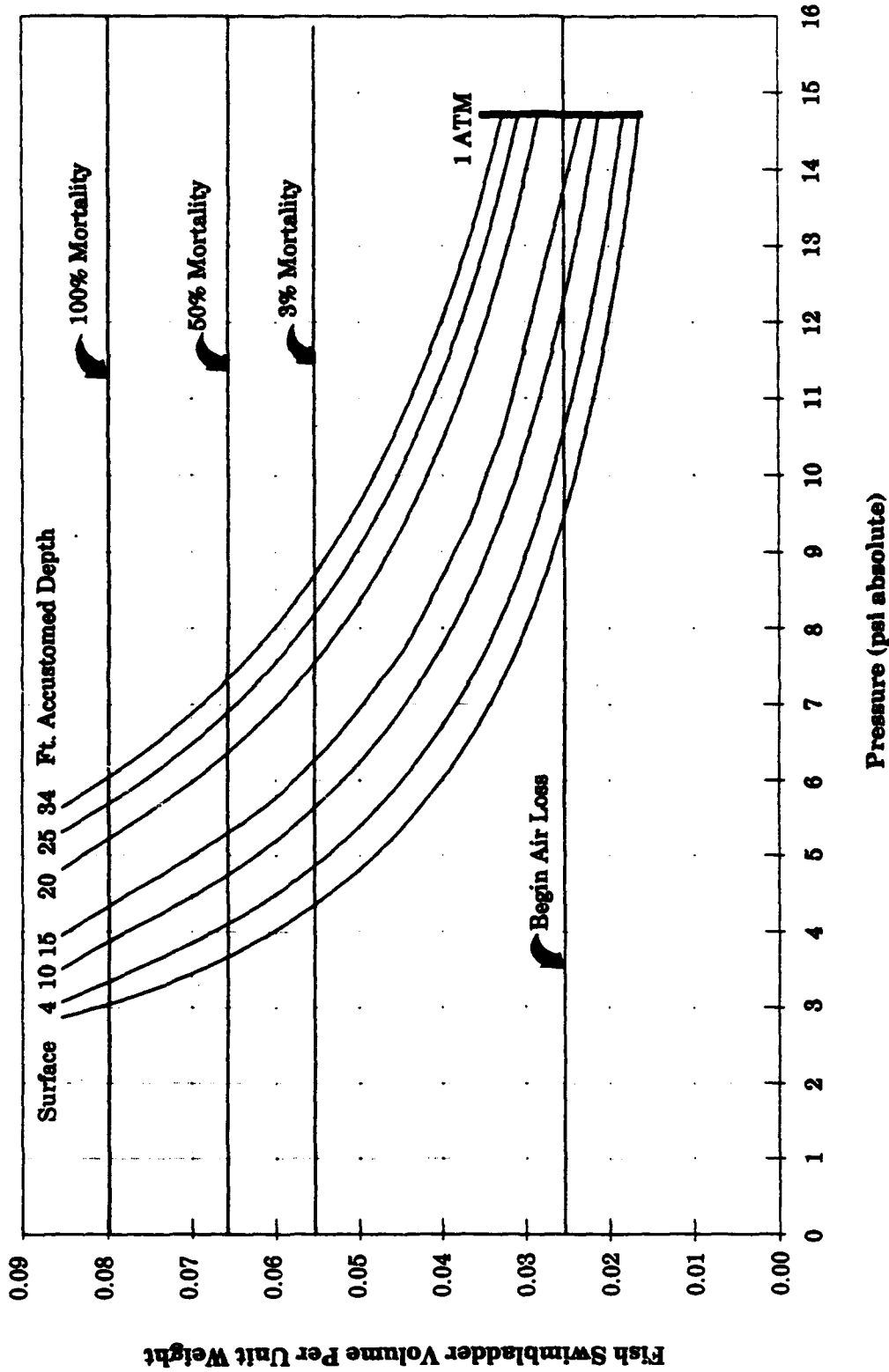

1.0167 is used as the specific gravity of flesh and bone of salmonids. Specific gravity of other species varies. Swimbladder volume of surface accustomed fish displaces water equivalent to specific gravity to provide neutral buoyancy. Specific gravity - Weight/Volume and Boyles Law, $(P)(V) = \text{Constant}$. For neutral buoyancy at 1 and 2 atm, unit volumes are 0.0167 and 0.0334 CC at surface, respectively.

PASSAGE of FISH THROUGH TURBINES, SPILLWAYS and CONDUITS

D
Representative Fish Passage Data for
Francis, Kaplan and Bulb Turbines
% Survival Vs. Head

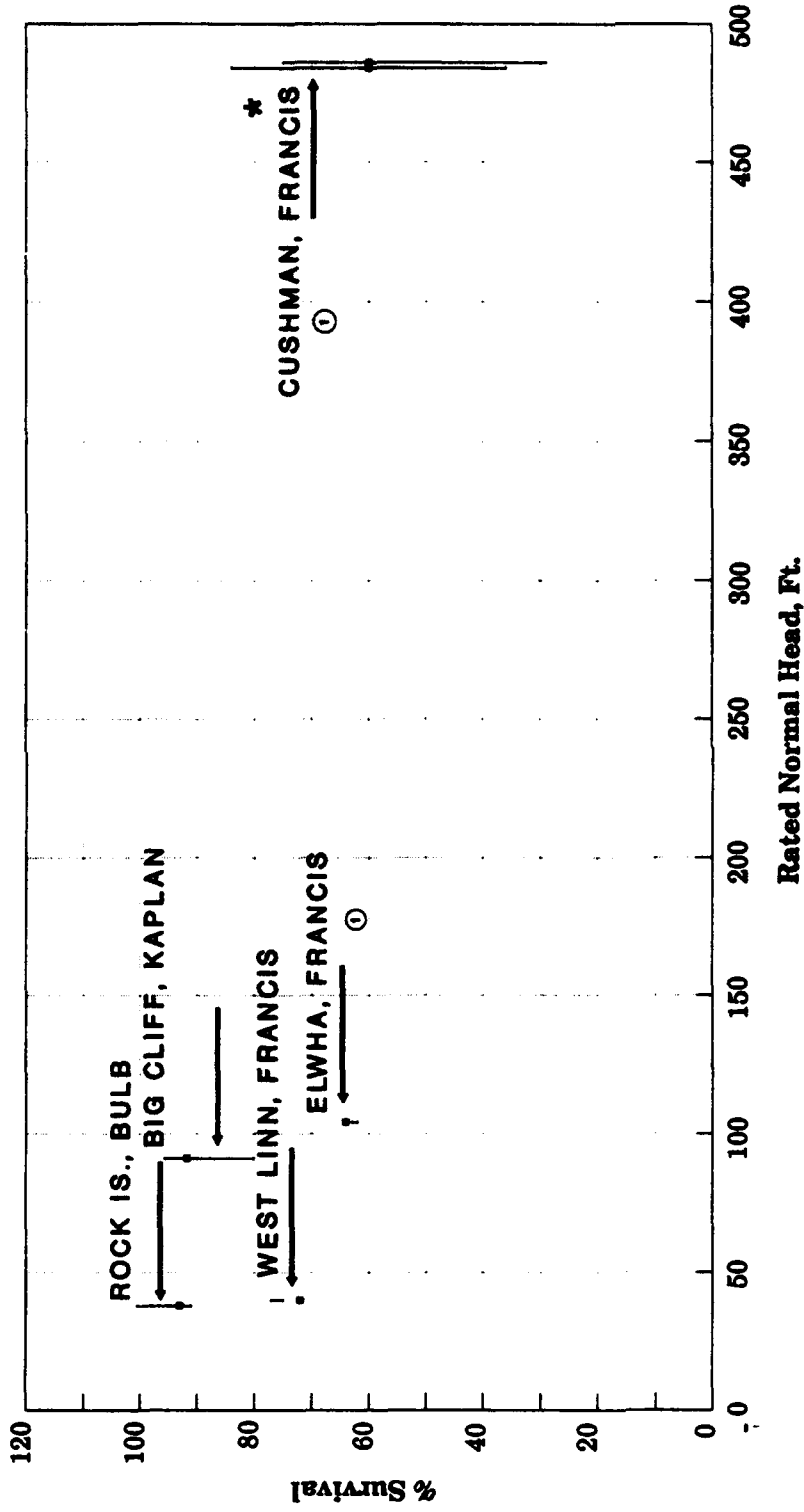

All values at same head. *
 Calculated survival shown as ←
 Tic marks at average reported value of range. ■
 Long penstock ①

PASSAGE of FISH THROUGH TURBINES, SPILLWAYS and CONDUITS

References Reviewed

1. Bell, Milo C., and Allan C. DeLacy, "A compendium on the survival of fish passing through spillways and conduits," with a special section on stilling basin hydraulics and downstream fish migration by Howard D. Copp. Report for U.S. Army Corps of Engineers, North Pacific District, Contract No. DACW-57-67-C-0105. Portland, Oregon. May, 1968.
2. Bell, Milo C., Allan C. DeLacy, and Gerald J. Paulik, "A compendium on the success of passage of small fish through turbines." Report for U.S. Army Corps of Engineers, North Pacific District, Contract No. DA-35-26-Civeng-66-16. Portland, Oregon. May, 1967.
3. Bell, Milo C., "Updated compendium on the success of passage of small fish through turbines." Report for U.S. Army Corps of Engineers, North Pacific Division, Contract No. DACW-68-76-C-0254. Portland, Oregon. September, 1981.
4. Bell, Milo C., "Revised compendium on the success of passage of small fish through turbines." Report for U.S. Army Corps of Engineers, North Pacific Division, Contract No. DACW-57-88-C-0070. Portland, Oregon. (In press.) 1989.
5. Eicher Associates, Inc., "Turbine-related fish mortality: review and evaluation of studies." Research Project 2694-4. Prepared for Electric Power Research Institute, 3412 Hillview Avenue, Palo Alto, California 94304. November, 1987.

Chapter 26

Artificial Guidance of Fish

Natural guidance factors may be used in artificial guidance.

Effects of light.

Temperature gradients.

Electric screens as barrier.

Bubble screens not effective.

Pressure change.

Depth consideration.

Velocity effect.

Use of louver screens.

Effectiveness of wire screens.

Precautions for screening devices.

Method of computing mesh size.

Approach velocity factor.

Discussion of accompanying exhibits.

Need for screen bypasses.

A. Louver Slats, Electric Fence.

B. Revolving Drum Screen.

C. Model "T" Screen

D. Representative Head Loss Through Screens.

E. Profile Screen.

F. Recessed Screen, Smooth-Faced Screen.

G. Angle Face With By-Pass, Reverse Angle Face

H. Side View of Screen Installations, Smooth-Faced Screen.

I. Typical Cross Section of Barrier Dam.

J. Plan View of a Barrier Dam Placed in a River.

References Reviewed.

ARTIFICIAL GUIDANCE OF FISH

Guidance may be defined as a means of directing fish from one location to another and includes both natural and artificial means. When artificial guidance works in concert with the phenomenon of natural guidance, the animal responds more readily. When offered a choice of stimuli causing guidance or movement, the fish may choose a single factor that may be dominant at that place and time.

Factors causing natural guidance are recognized as light and shadow (or its absence), velocity, channel shapes, depth, sound, odor, temperature and perhaps others. These may also be utilized for artificial guidance. See Chapter 24, "Movement of Downstream Migrants," for information on light, and Chapter 18, "Avoidance," for sound effects.

In the field of artificial guidance, the stimuli also include mechanically developed factors such as bubbles, electric fields and high velocities. Chemical barriers that produce avoidance reactions may be used, but generally are not considered practical; however, certain chemicals cause complete rejection of an area of a stream or strong fright reactions but not necessarily guidance. Visual references are associated with illumination of objects. It is assumed that under natural conditions, fish utilize targets as a measure of position or movement. In the fields of screening or fixed barriers, wire screens, both fixed and movable, louvers and rack bars are used. The use of these screens may be coupled with target references or velocity references. In channel shaping, depth may be used to direct fish into deeper areas or to maintain them at their desired levels. As velocity can be a barrier, it is possible to manipulate spillways or turbine discharges to reject from, attract to or hold fish in specific areas. In the use of depth, by setting intakes at +3 atmospheres, the pressure or depth factor acts as a screen. Other methods that have been tried are visible curtains, such as chains or metal strips.

It is evident from the above listing that more than one phenomenon may be present at a screening location. When all factors work together, the most effective guidance is obtained. Individual fish or groups of fish may respond more readily to one particular stimulus, which can override others, i.e., the fish's instinct to move from areas of sunlight to shade, or their reluctance to move from their selected depth or velocity gradient, etc. There is no evidence that fish learn with one experience: under pond conditions, with repeated applications, fish will learn to respond to painful experiences by avoidance and to feeding rewards by attraction.

Light, when used artificially as a guidance stimulus, repels fish at higher intensities and attracts them at the lower intensities. Under natural conditions, fish react to moonlight. This habit is taken advantage of in commercial fishing by net placement in dark areas of streams.

Turbid or discolored water, which diffuses and absorbs light, also affects movement by obscuring targets and other visual references.

When velocities are used, it must be kept in mind that fish react to changes of less than .1 fps or at a level below current meter measurement. As swimming ability is a function of length, ambient temperature and oxygen level, such factors must be measured and the guidance velocities used must be within the allowable parameters shown in Chapter 6, "Swimming Speeds of Adults and Juveniles," and Chapter 11, "Temperature - Effects on Fish." Lighting at projects is constantly being changed and may become a

variable in passage as it may inadvertently become a guidance mechanism, and this factor should be considered in the operation of fishway facilities, particularly at entrances and exits.

Under natural conditions, visual references are known to be present in fishing operations, such as leads, natural kelp beds and symmetrically placed objects as piling. Shore lines act as natural guides and such guides can be used effectively when placing entrances and exits at fish facilities structures. Conversely, when these act as negative attraction, they should be avoided. Sudden transitions from shore lines to deep pools should be avoided, where possible. Sloping surfaces or ledges may be utilized for the transition.

There is no evidence to explain why fish enter areas of higher than desirable temperature (and may initially choose them) as they normally will seek the most equitable temperatures. Adverse high temperature gradients at surfaces will generally be avoided by cold water species, provided that the more equitable temperature areas are not devoid of oxygen. Surface outlets may be rejected as a part of the total area that is being rejected. Warm areas may be sought in times of critical low temperature. There is no evidence that an immediate change of temperature is a direct guidance stimulus at the point of transition.

It is generally expected that upstream migrants will seek the farthest upstream point. Downstream migrants move to the lowest point possible. As a general rule, this results in guidance and indicates a good location for entrances. Blind corners, particularly with 90 degree angles, should be avoided as fish tend to accumulate at such points and may jump, with subsequent injury. Such areas, coupled with upwelling, are particularly objectionable for smooth passage.

Chemicals that cause avoidance are discussed in Chapter 18, "Avoidance."

Electric screens have not proved to be successful in guidance but may be used as a barrier. Shocked fish are usually swept downstream, making electric fields generally ineffective for guidance. (See Chapter 11, "Temperature - Effects on Fish," and Chapter 29, "Recovery Gear.") (See Exhibit A for a general arrangement of electrodes.)

Although the literature shows that fish have an immediate response to bubbles (which may be a fright response), experiments with salmonoid fish indicate that bubble screens are not effective in either stopping or guiding. There is evidence that fish will lead, to some degree, along lighted bubbles but this advantage is negated under conditions of darkness or turbidity. The literature discloses that a fright reaction may be engendered by sound, hanging chains, light or other phenomena beyond ambient.

Pressure change is useful as a guidance mechanism, as it has been found that fish do not readily sound, even though instantaneous increases are not harmful. Feeding fish in lakes, however, are known to move vertically under darkness conditions but avoid deep areas under lighted conditions, indicating that the instinct to be guided by pressure can be negated by stronger stimuli.

Fish normally approach facilities in a limited range of depths and, ideally, attractive entrances should be placed at such depths. Most adult salmon may be assumed to be

ARTIFICIAL GUIDANCE OF FISH

between the surface and 6 feet of depth, and practically all are between the surface and 12 feet of depth at dams and falls. This pattern may be varied, of course, by temperature, turbidity and oxygen levels. The bulk of the downstream migrant salmonoids may be assumed to be within the first 3 feet of depth (small streams), but it must be recognized that throughout a season they will be dispersed as light, turbidity, temperature and stream depth change.

Velocity may be used as a barrier or to attract fish. Swimming speeds, which are related to the ability of fish to translate their stored energy into movement, are shown in Chapter 6, "Swimming Speeds of Adult and Juvenile Fish." Cruising speeds generally are attractive, and the upper limits of darting speeds, a barrier. Sustained speeds over a period of time may also become a barrier. Owing to the fish's ability to sense low velocities, transfers across velocity gradients should be avoided, if possible, and acceleration and deceleration should be gradual throughout the range of sustained speed.

Barrier dams prevent passage by creating upper darting velocities, but also provide attraction velocities to the entrance located at the farthest upstream point. (See Exhibits I and J.)

Louver screens work on a guidance velocity principle but present operational difficulties in providing a continuing combination of ideal conditions. They are not commonly recommended where complete screening is required. Louver screens, as do bar racks, accumulate debris, which may effectively alter the ideal velocity conditions as designed. Exhibit A depicts the louver principle. The fish is carried along the face of the louver array by the flow. It generally lies pointed upstream but not parallel with the flow and thus is kept free of the louver face. The swimming effort generated must be sufficient to keep the fish from entering the velocity through the louver slats, but not sufficient to overcome the transport velocity.

Wire screens are the most effective method of providing guidance or preventing penetration of fish into an intake. As screens collect debris, there must be a washing mechanism. The back wash principle is shown on Exhibit B. The drum screen operates on a revolving principle, with the debris washed free from the downstream side. The same principle can be used on the commercially built travelling water screens, although these are normally cleaned by sprays behind the upstream face.

Exhibit C shows a fixed screen that is cleaned by a trash rake. This type of screen is now in limited use.

All screening devices have common problems, including debris. They are subject to damage by heavy floating objects and must be protected by guards. They are affected by bed load movement and so must pass sands and gravels. They must be protected against icing, where such conditions prevail. They require a head differential sufficient to pass water through the mesh. The mesh openings must be small enough to prevent passage of the juvenile fish to be diverted. When requirements call for smaller mesh sizes, problems associated with filamentous algae are encountered.

Fish behavior must be considered as it varies throughout a season and among species. Salmonoid behavior differs under daylight and darkness conditions. Fish trapped on the face of screens suffer the loss of gill action and may

quickly smother. Fish plastered on a screen face cannot readily lift themselves against the velocity, although they may swim laterally. Where lateral movement is required, the screen face must be free of projections. The variability in face alignment should not exceed .4 of the fish's width and should be rounded.

Fish are stopped generally by the dimension of the bony part of the head and square mesh is more effective than slotted mesh as the fish have a greater depth than width measurement. This does not hold for profile screens whose slots are horizontal. (See Exhibit E.) The following gives a method of computing mesh size but must be used with care as there is a great lack of measurement of fish on which to base a universal formula.

M = Maximum screen mesh opening in inches

L = Length of fish in inches

D = Depth of fish in inches

$L/D = F$ (Fineness Ratio)

$M = [.04 + (L-2.35).04]F$ where F is 5 to 6.5

$M = [.03 + (L-1.86).03]F$ where F is 6.5 to 8

$M = [.02 + (L-1.6).02]F$ where F is 9+

As F becomes greater, the body depth approaches the skull depth, which is the governing depth for nonpenetration. Number of fish used for F values was small and the formulae should be used only as a guide. Samples at all sites should be measured for true values.

Because of the problem of fish being plastered against all screens, head losses should be held to a minimum and are recommended to be not over .25 inch or .02 foot. Exhibit D shows the percent of opening area in screens as affecting head loss. It is noted from this exhibit that a screen angled at 45 degrees with the current is slightly more effective in passing water. Generally speaking, a wire screen will lose the head required to produce the velocity through the mesh. From the standpoint of fish efficiency, velocity of approach and head are the governing factors.

The variability in swimming performances due to size, temperature and oxygen is described in Chapter 6, "Swimming Speeds of Adult and Juvenile Fish." The size of fish to be stopped must be known in order to properly set a minimum velocity of approach.

It must be kept in mind that when their references are lost because of darkness or turbidity, fish are more apt to be swept against the screen and killed. This factor must be weighed in the choice of approach velocity.

Exhibits F, G and H indicate typical configurations of screening installations. Exhibit F (top) is the one most commonly used in water screen design, but it is least effective for fish protection because of the lack of directional guidance, pocketing in the corners, poor escape areas and a requirement that the fish swim back upstream to escape. Exhibit F (bottom) and Exhibit H are the preferred types of installation. They use smooth-faced screens with directional guidance and without pocketing.

These sketches show principles rather than design and can be utilized at moving or fixed screen installations. As these screens as depicted require low velocities, any protective trash racks required should be kept free of the screens, thereby eliminating interference to the lateral movement. Winter protection can be provided by housing and other methods, such as heating or introduction of warmed water.

ARTIFICIAL GUIDANCE OF FISH

Exhibit I shows an adult barrier dam or guidance dam. The first sketch uses height as a means of preventing fish from passing over the barrier. The second sketch uses velocity as a barrier and, to reduce the adult fish swimming ability, the depth of the water on the face should be less than the fish's depth.

Such dams may be used to guide fish if set at an angle across the flow, as shown on Exhibit J.

Because of their location, many screens require by-passes, which accumulate and concentrate fish, inviting predation. By-pass outlets should provide for dispersion or introduction into areas that discourage predator concentration, such as high velocities or upwelling. Entrances into by-passes should provide smooth transition.

Submerged Travelling Screens (STS) have been installed at a number of dams on the Columbia River. They cover the upper part of the intake area. The effects of their operation has varied from dam to dam or from installation to installation. They are most effective when the downstream migrants are concentrated in the layers of water above the lower end of the travelling screen.

In some instances there have been varying degrees of descaling and there are recorded losses at the installations.

As is the case with all travelling screens, debris presents a problem; breakdown of equipment and the length of life of the equipment are factors.

As there have been a number of studies at the various sites, it is recommended that these be reviewed before the use of STS is proposed at a specific site.

Light and sound are being studied as to their effects on efficiency, or to improve efficiency of operation of the STS.

There are also small losses in the collection system which vary according to design and from location to location.

A submerged incline plane screen (Eicher screen) has been developed. As this is a patented screen, it is suggested that George Eicher be contacted for information concerning its efficiency of operation and its adaptability to specific sites. (Reference 100.)

See Chapter 5, "Useful Factors in Life History of Most Common Species," for table entitled "Biological Information on Some Common Species in Continental United States."

ARTIFICIAL GUIDANCE OF FISH

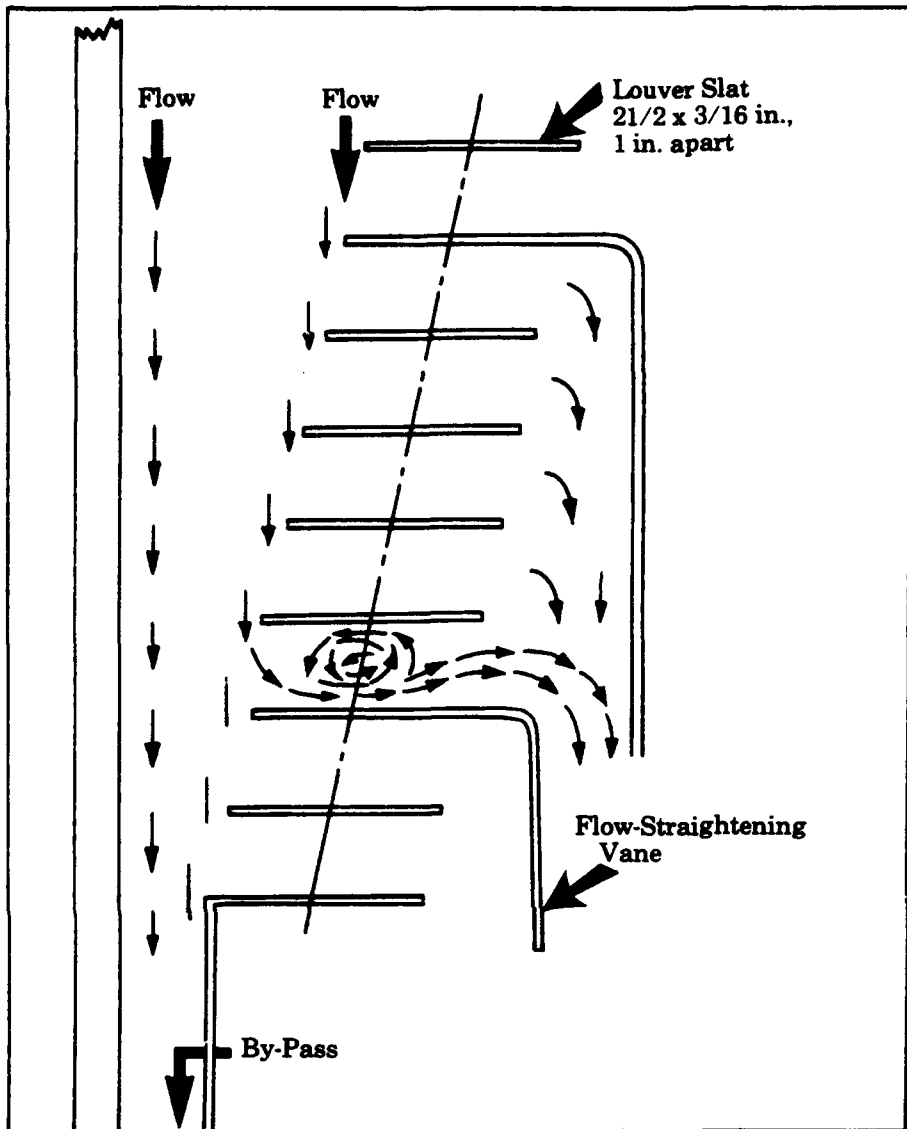

A
Louver Slats

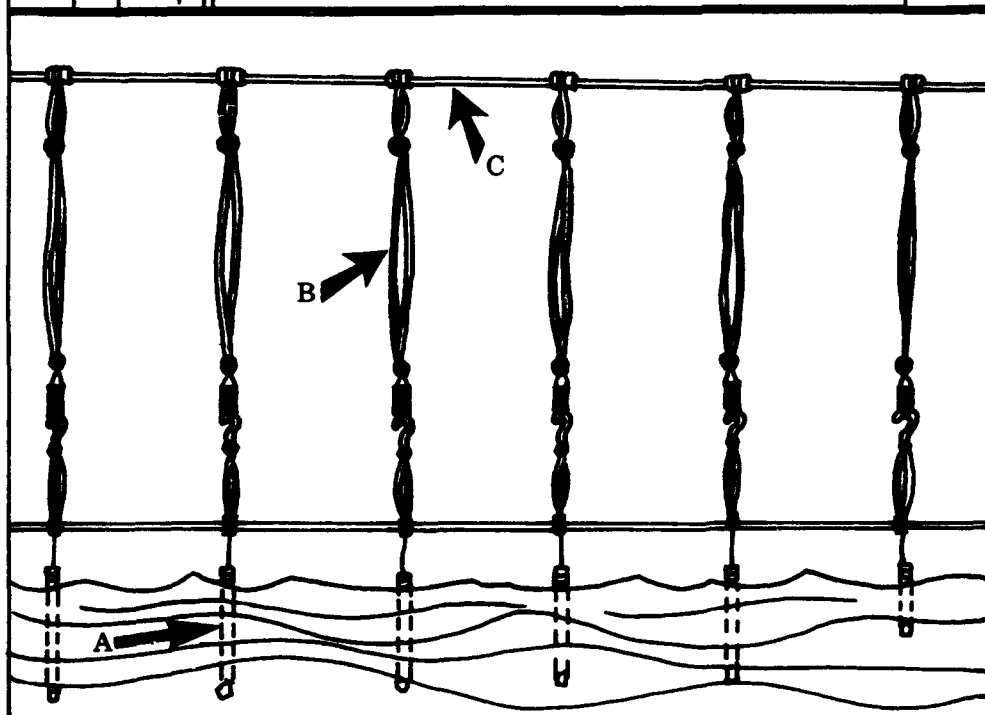

Electric Fence

- A - Electrodes
- B - Support Cable Vertical
- C - Support Cable Horizontal

ARTIFICIAL GUIDANCE OF FISH

B Revolving Drum Screen

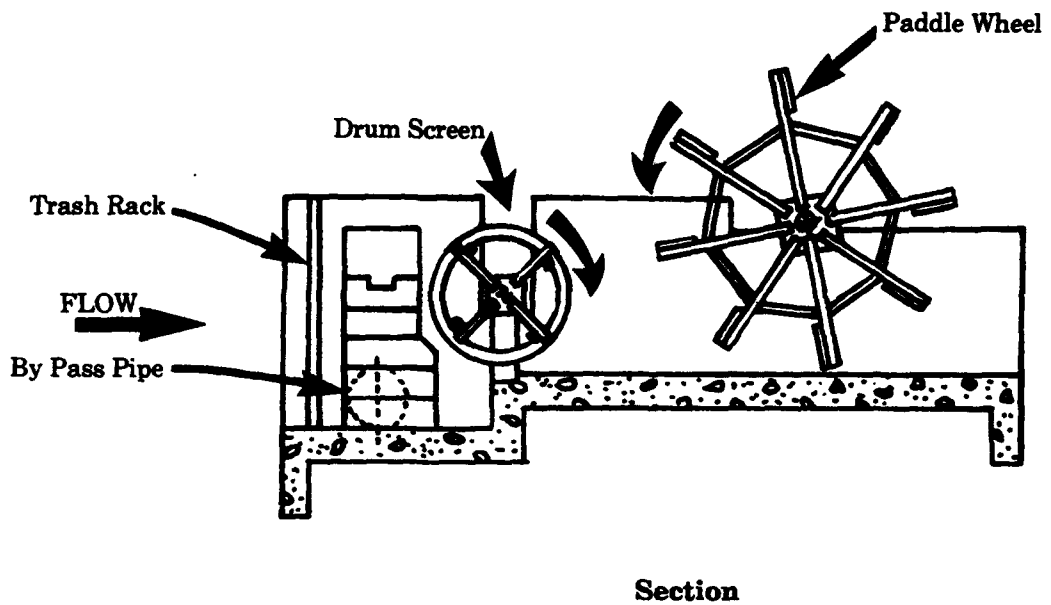
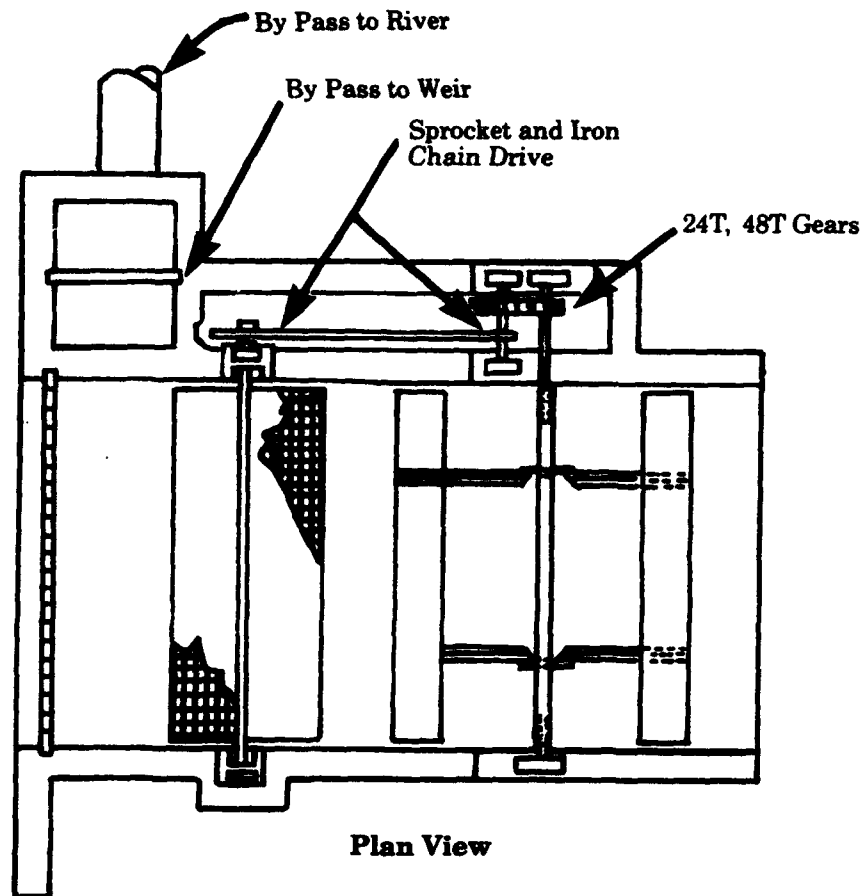

ARTIFICIAL GUIDANCE OF FISH

C

Model 'T' Screen

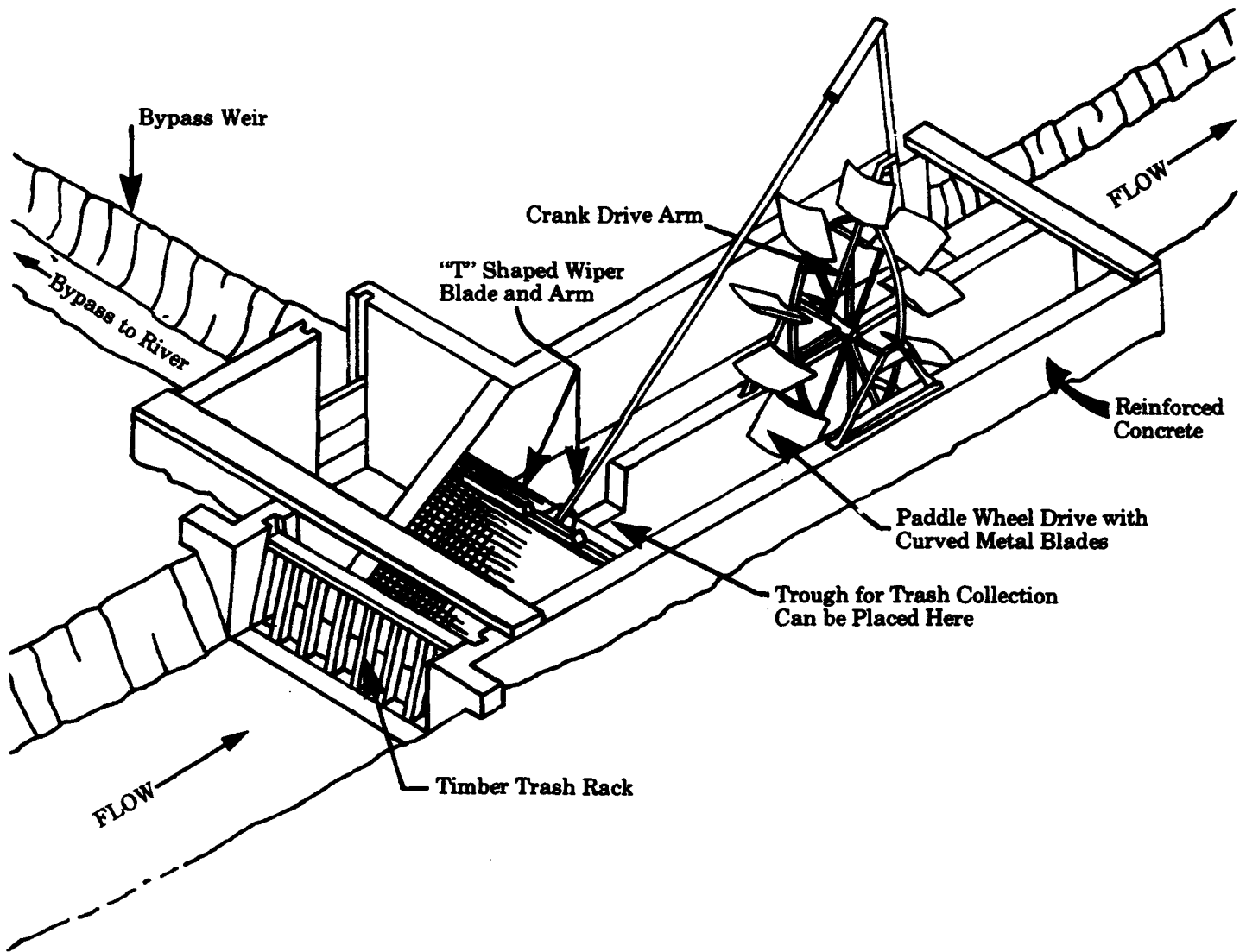

ARTIFICIAL GUIDANCE OF FISH

D

Representative Head Loss Through Screens
 Head discharge curve and associated curve indices
 for a plan screen with an open area of 63.3%
 placed in the vertical position (90°) compared
 with 48% and 67% openings.

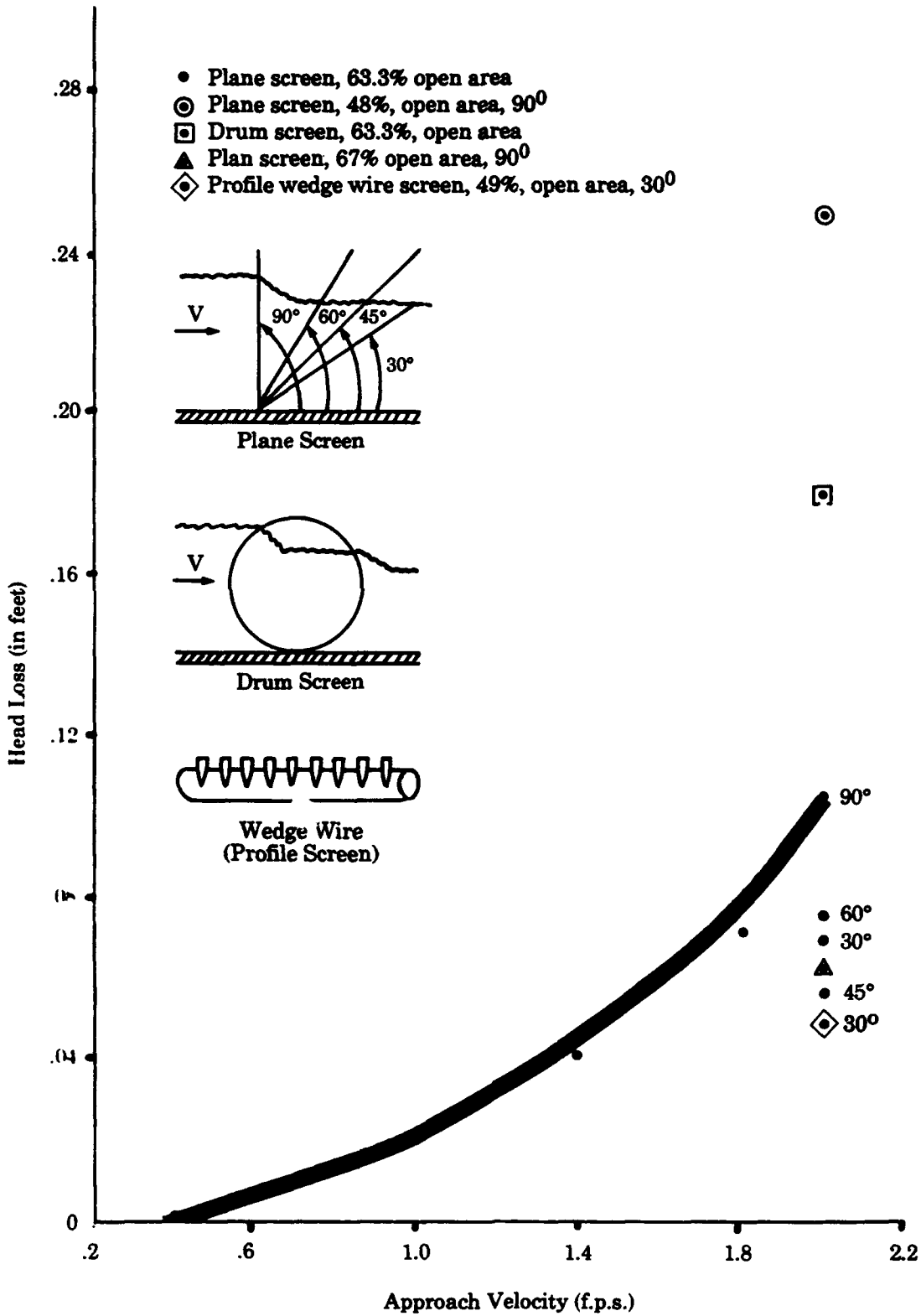

ARTIFICIAL GUIDANCE OF FISH

E Profile Screen Two Possible Locations

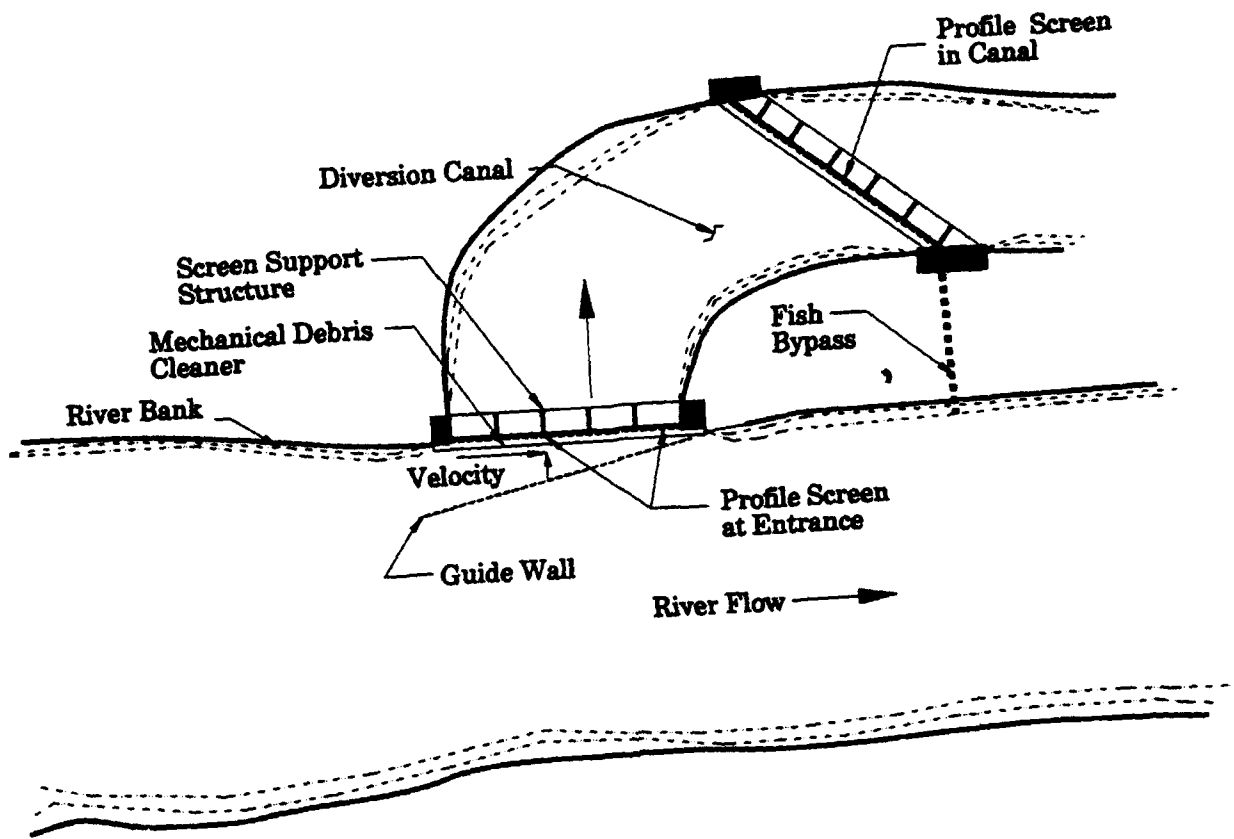

Note: Horizontal screen slot openings. Head dam may be required. Guide wall may be required to maintain sweeping velocities.

ARTIFICIAL GUIDANCE OF FISH

F
Recessed Screen
No By-Pass
(Poor Design)

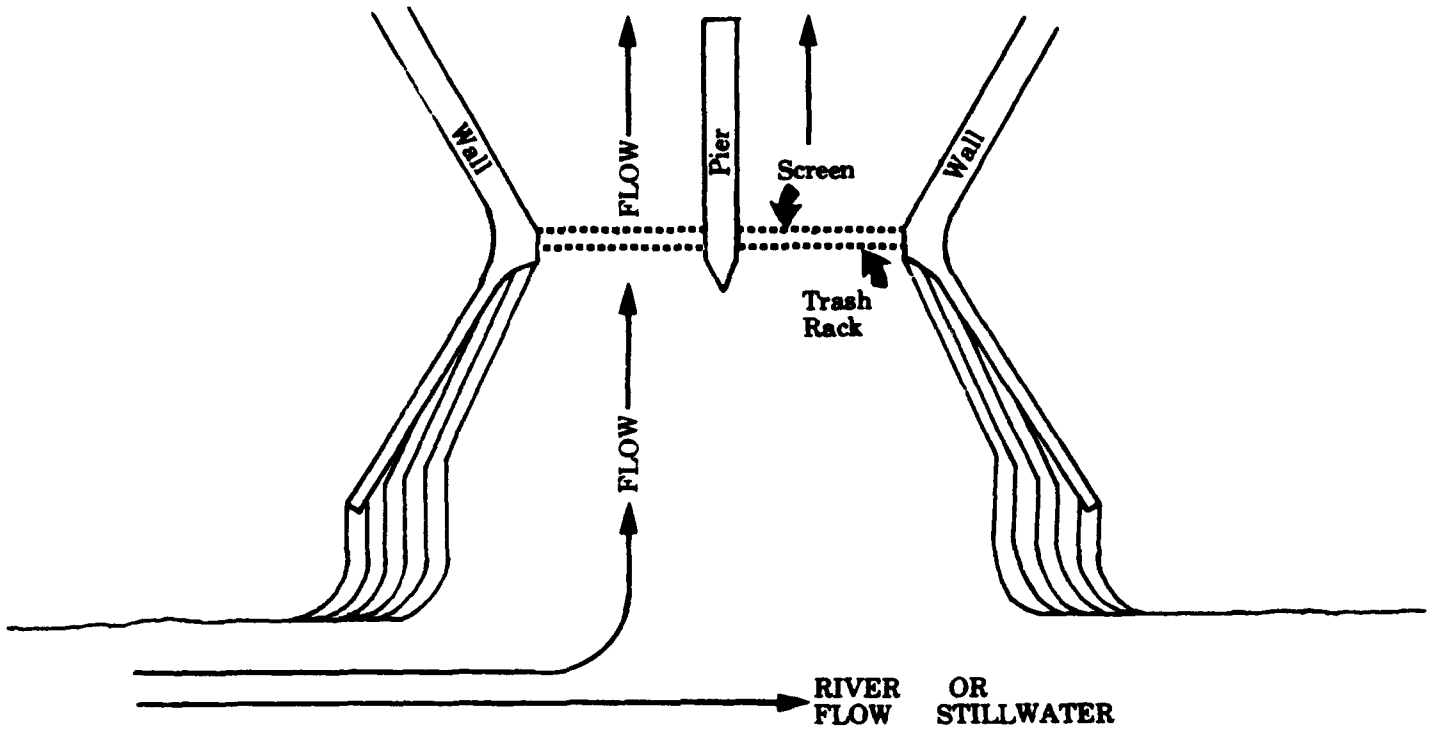

Smooth-Faced Screen
River Becomes By-Pass
(Good Design)

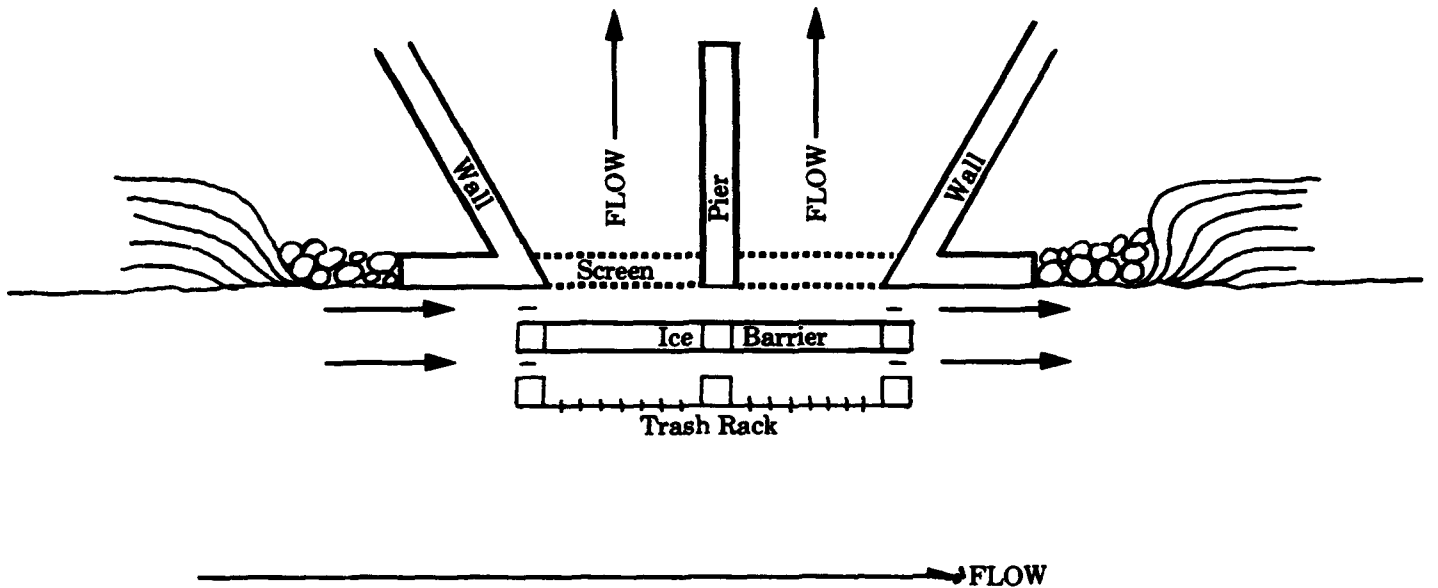

ARTIFICIAL GUIDANCE OF FISH

G

Angle Face
With By-Pass
(Good Design)

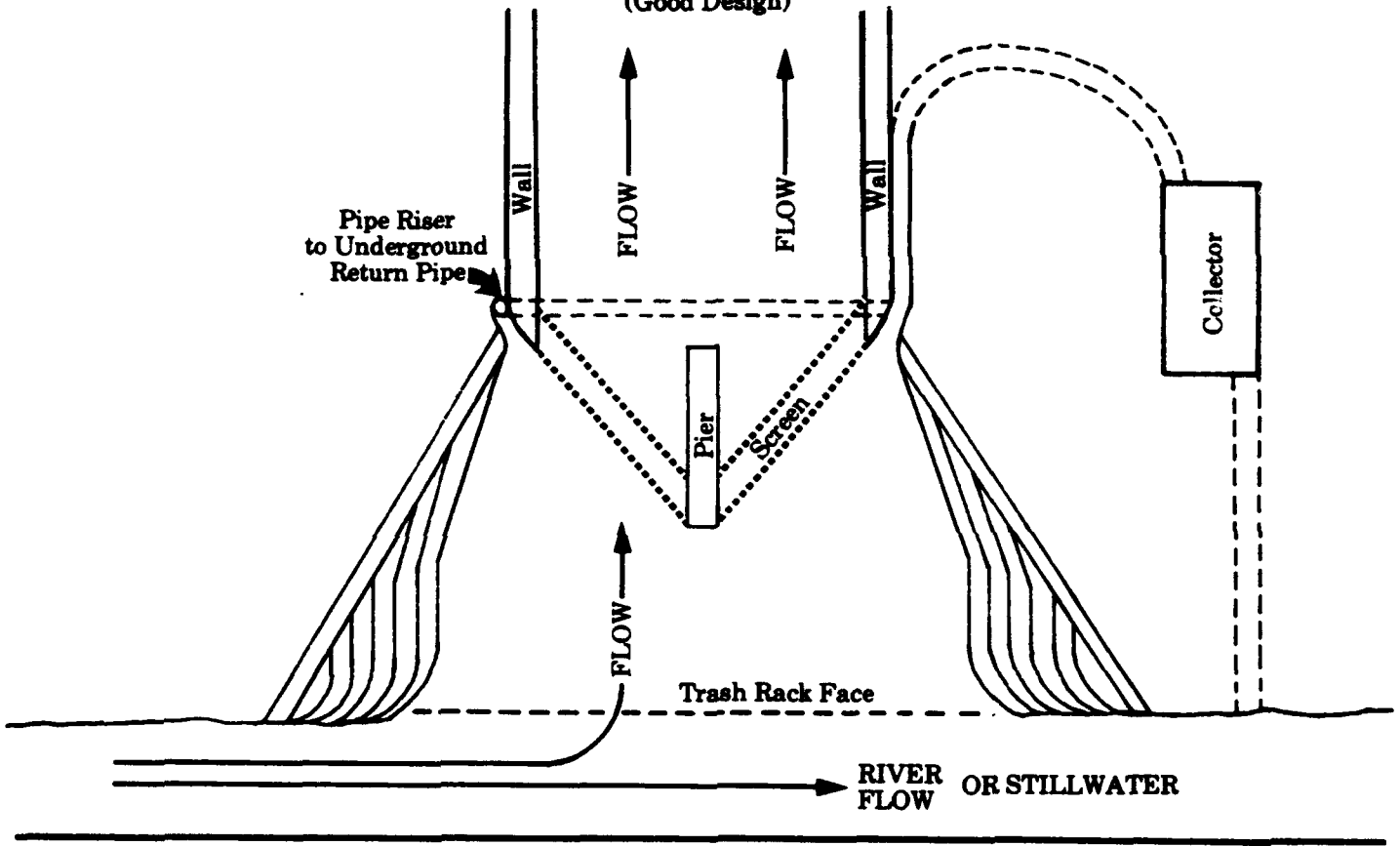

Reverse Angle Face
Using One By-Pass
(Best Design)

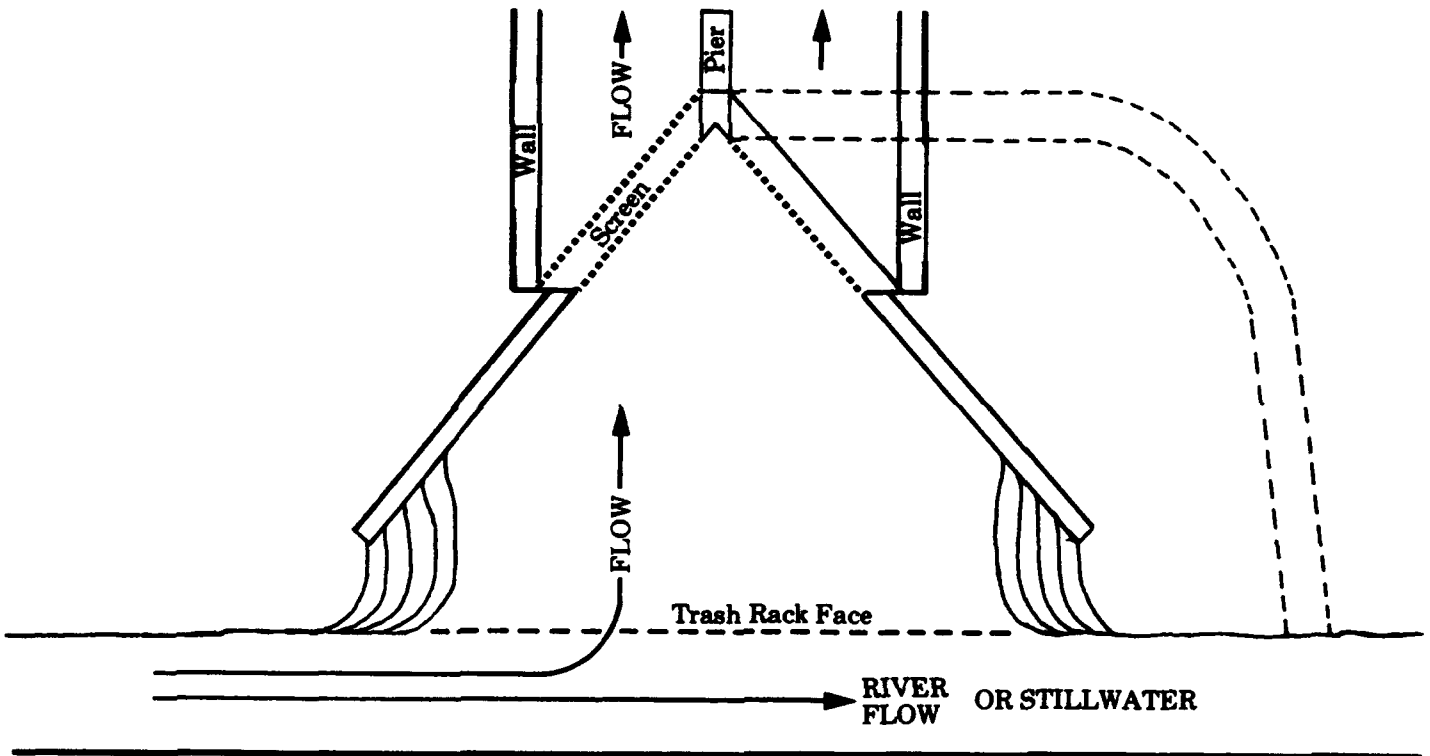

ARTIFICIAL GUIDANCE OF FISH

H

Side View of Screen Installation With Alternate Uses of Curtain Wall and Trash Rack

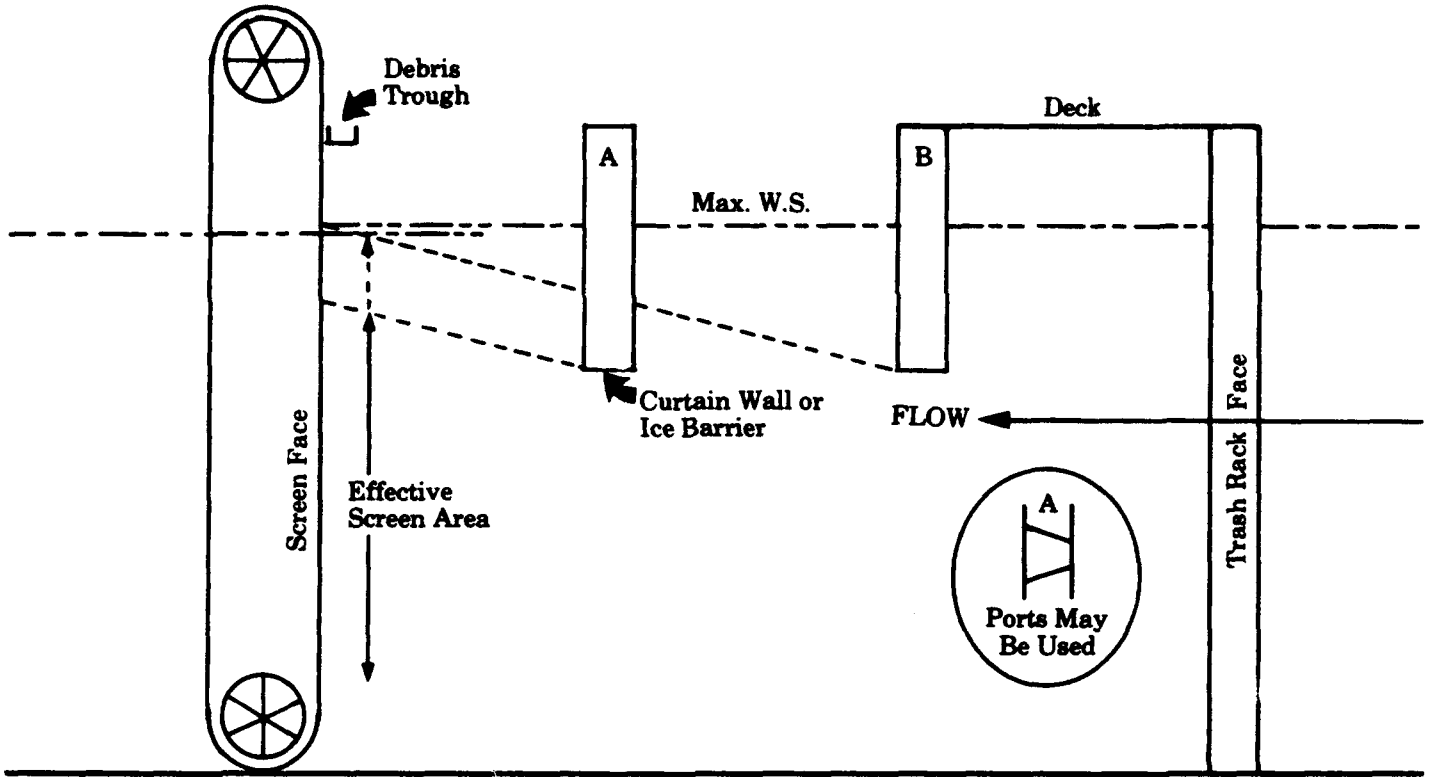

Smooth-Faced Screen

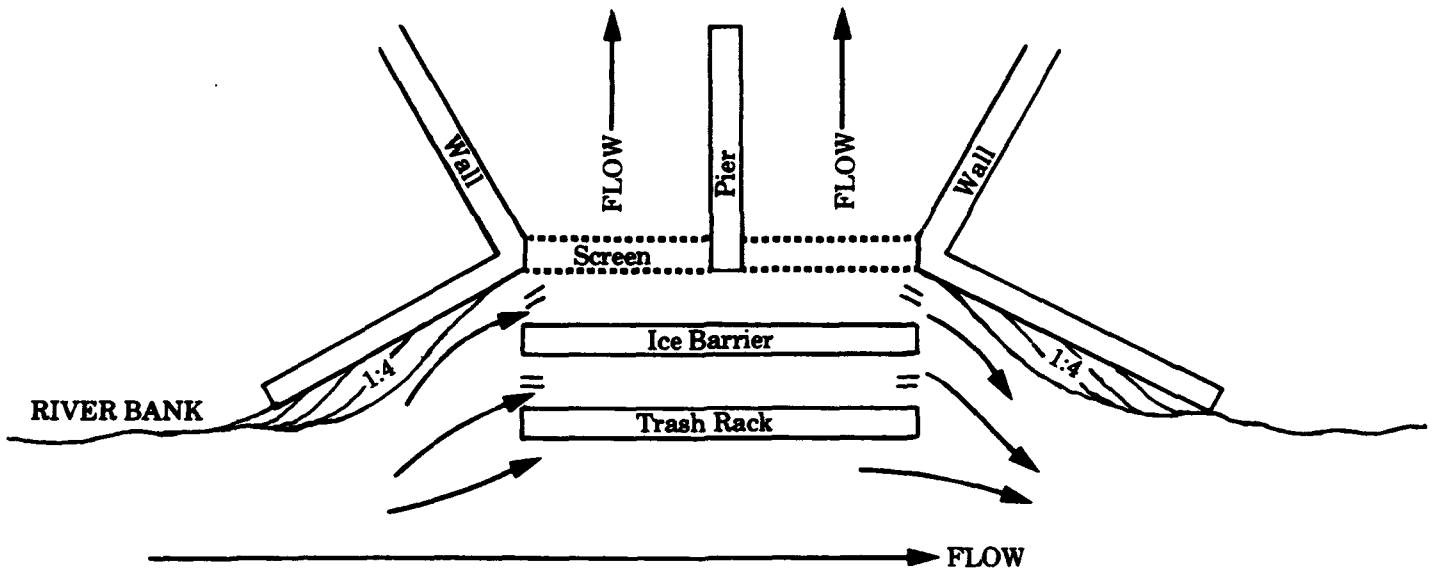

ARTIFICIAL GUIDANCE OF FISH

I Typical Cross Section of Barrier Dams

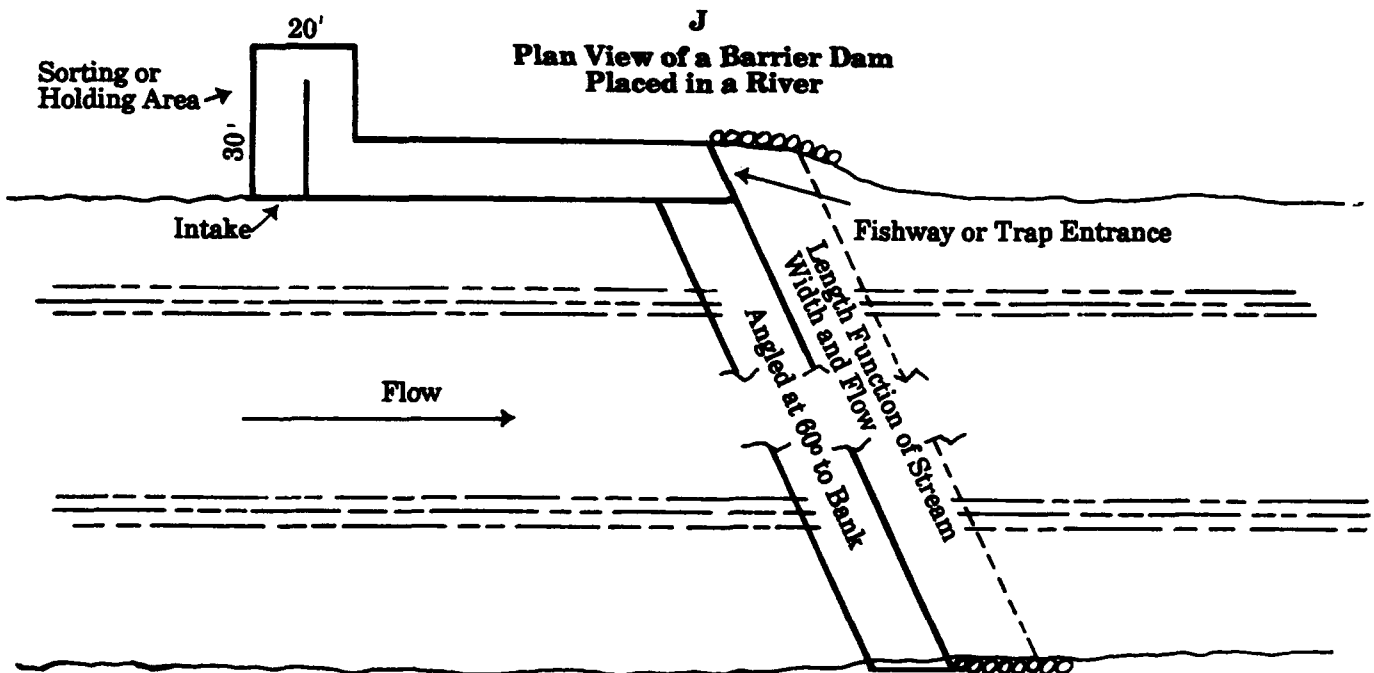
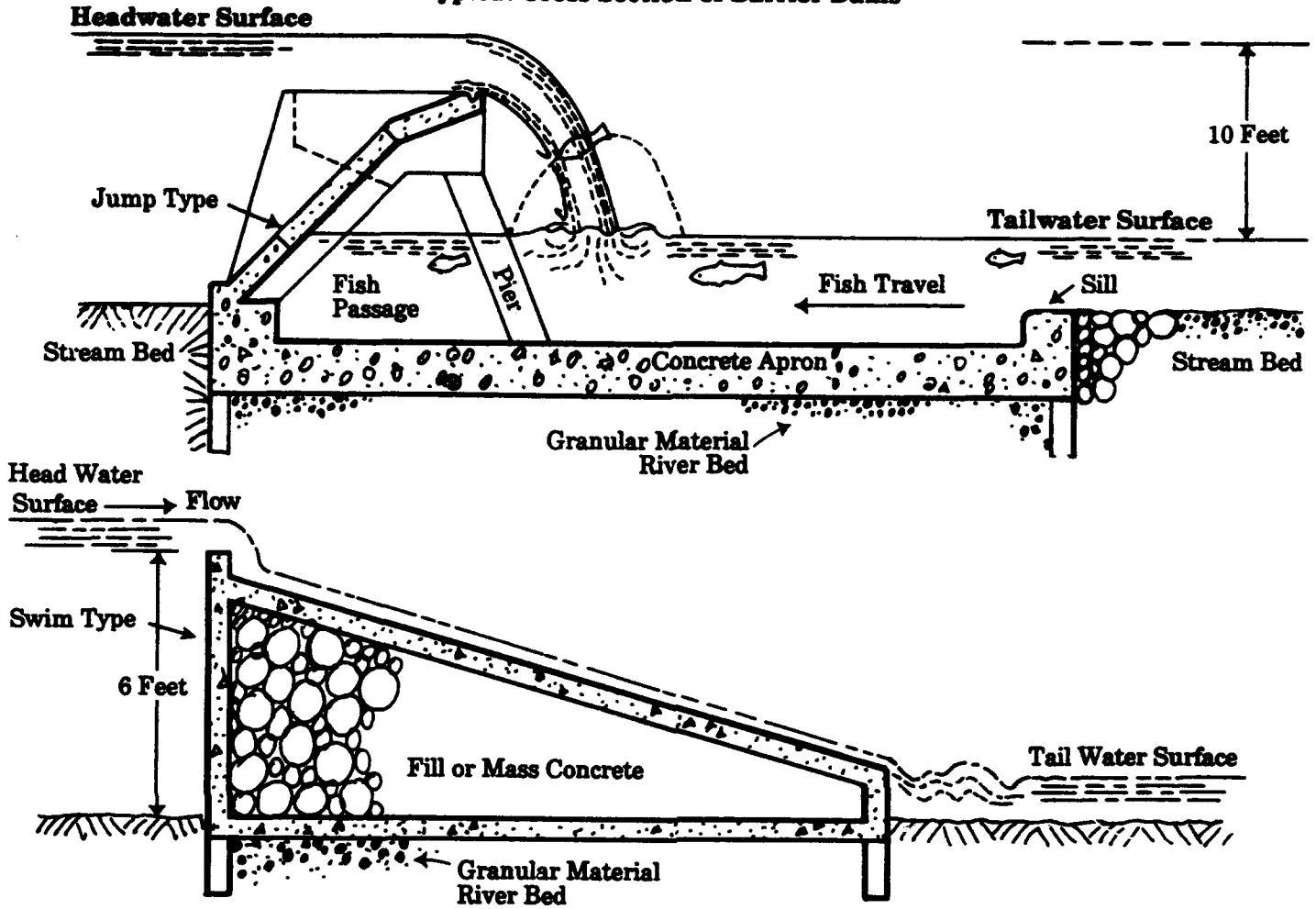

ARTIFICIAL GUIDANCE OF FISH

References Reviewed

1. Kerr, James E., "Studies on fish preservation at the Contra Costa steam plant of the Pacific Gas and Electric Company." California Department of Fish and Game, Fish Bulletin 92. 1953.
2. Brett, J.R., D. Mackinnon, and D.F. Alderice, "Trough experiments on guiding sockeye salmon fingerlings." Fisheries Research Board of Canada, Progress Reports of the Pacific Coast Stations, No. 99:24-27. July, 1954.
3. Fields, P.E., G.L. Finger, and L.A. Verhoeven, "The use of a chain barrier to guide young salmon." School of Fisheries, Report No. 1:1-11. University of Washington, Seattle. 1954.
4. Pugh, John R., Gerald E. Monan, and Jim Ross Smith, "Attempt to guide seaward-migrating Pacific salmon and trout with long leads." The Progressive Fish-Culturist, 31(3):174-176. July, 1969.
5. U.S. Army Corps of Engineers, North Pacific Division, "Progress report on fisheries-engineering research program." Portland, Oregon. November, 1956.
6. U.S. Army Corps of Engineers, North Pacific Division, "Progress report on fisheries-engineering research program." Portland, Oregon. July, 1960.
7. U.S. Fish and Wildlife, Pacific Salmon Investigations, "The effect of electric shock upon reproductive ability of salmonoids." Technical Progress Report No. 15 by Galen H. Maxfield. May, 1956. (Preliminary report...not for public release.)
8. Fields, P.E., G.L. Finger, R.J. Adkins, R.E. Carney, and R. Pyke, "A factorial study of the response of steelhead trout, chinook and silver salmon fingerlings to chain barriers in moving water." Unpublished report. School of Fisheries, Technical Report No. 13:1-7. University of Washington, Seattle. June, 1955.
9. Brett, J.R. and C. Groot, "Some aspects of olfactory and visual responses in Pacific salmon." Fisheries Research Board of Canada, Journal, 20(2):287-303. March 1963.
10. Fields, Paul E., "Migrant salmon light guiding studies at Columbia River dams." Final report submitted to the U.S. Army Corps of Engineers, North Pacific, Fisheries Engineering Research Program, Contract No. DA 47-108-Civeng-63-29. February, 1966.
11. Adkins, Ronald J., and Paul E. Fields, "Conditioning young steelhead trout to colored lights." Unpublished report. School of Fisheries, Technical Report No. 33:1-20. University of Washington, Seattle. June, 1957.
12. Johnson, Donald Everett, "The application of certain conditioning and handling techniques to the guidance of downstream migrant salmon." Ph.D. thesis. University of Washington, Seattle. 1957.
13. Nakatani, Roy E., "Effects of electroshock on some blood constituents of salmon. I. Inorganic phosphate and hematocrit values of the blood of young silver salmon." Unpublished report. School of Fisheries, Technical Report No. 15:1-14. University of Washington, Seattle. 1955.
14. Carney, R.E., and R.J. Adkins, "Reactions of young silver salmon in ten velocity combinations." Unpublished report. School of Fisheries, Technical Report No. 23:1-15. University of Washington, Seattle. August, 1955.
15. Brett, J.R., and D. Mackinnon, "Preliminary experiments using lights and bubbles to deflect migrating young salmon." Fisheries Research Board of Canada, Journal, 10(8):548-559. November, 1953.
16. Fields, P.E., G.L. Finger, and R.J. Adkins, "The effect of electric lights upon the upstream passage of three species of adult salmon through the University of Washington fishladder." Unpublished report. School of Fisheries, Technical Report No. 12:1-13. University of Washington, Seattle. March, 1955.
17. Andrew, F.J., P.C. Johnson, and L.R. Kersey, "Electric screens for adult salmon." International Pacific Salmon Fisheries Commission, Progress Report No. 2. 1956.
18. Holmes, H.B., "History, development, and problems of electric fish screen." U.S. Fish and Wildlife Service, Special Scientific Report - Fisheries No. 53. Washington, D.C. 1948.
19. Washington Department of Fisheries, "Fall chinook released into Minter Creek, 1954-55." In its "Progress Report", Minter Creek Biological Station, Spring - 1955, Part III. Unpublished. 1955.
20. International Pacific Salmon Fisheries Commission, "The head-discharge relationships for wire screens in plane and cylindrical forms: a contribution to fish research." Unpublished report by Fred J. Andrew. New Westminster, B.C. January, 1951.
21. Fields, Paul E., "Diverting downstream migrants from the McNary Dam turbines into the trash sluiceway and emergency gate slots." College of Fisheries, Technical Note 55. University of Washington, Seattle. In his "Migrant Salmon Light Guiding Studies at Columbia River Dams." Final report...Seattle. February, 1966.
22. Brett, J.R., and D. MacKinnon, "Experiments using lights and bubbles to deflect migrating young spring salmon." Fisheries Research Board of Canada, Progress Reports of the Pacific Coast Stations, No. 92:14-15. October, 1952.
23. "Fish escapement study, Marmot screens." Annual Report, p. 253. Oregon State Game Commission, Portland, Oregon. 1957.
24. Munro, W.R., "The use of louver screens as a means of diverting salmon smolts." International Council for the Exploration of the Sea, Salmon and Trout Committee, Committee Minutes No. 33. 1965. (*This paper not to be cited without prior reference to the author.*)
25. Kupfer, George A., and William G. Gordon, "An evaluation of the air bubble curtain as a barrier to alewives." Commercial Fisheries Review, 28(9):1-9. September, 1966.

ARTIFICIAL GUIDANCE OF FISH

References Reviewed (Continued)

26. Fields, P.E., G.L. Finger, and L.A. Verhoeven, "The effect of electric shock upon the light avoidance behavior of young silver and blueback salmon." School of Fisheries, Report No. 3:1-18. University of Washington, Seattle. 1954.
27. Washington Department of Fisheries, "Preliminary report on the light guidance and inverted weir structures as aids in migration through the White River screening system." Unpublished report by William A. Dunstan. Bound with its "Preliminary report on variations of fat content in adult Columbia River sockeye salmon migrants, March 1954-November 1954." Olympia, Washington.
28. Craddock, Donovan R., "Review of literature on guiding fish with lights, fish vision, and reactions of fish to light." Submitted to the U.S. Army Corps of Engineers. Work Item A-9, unpublished, U.S. Fish and Wildlife Service, Pacific Salmon Investigations, Seattle, Washington. September, 1951.
29. Enami, Sumio, "Studies on the bubble-net. II. Experiments on some sea-water fishes performed on the driving and intercepting effects." Japanese Society of Scientific Fisheries, Bulletin, 26(3):269-272. March, 1960.
30. Smith, Keith A., "Air-curtain fishing for marine sardines." Commercial Fisheries Review, 23(3):1-14. March, 1961.
31. Andrew, F.J., and G.H. Geen, "Sockeye and pink salmon production in relation to proposed dams in the Fraser River system." International Pacific Salmon Fisheries Commission, Bulletin XI. New Westminster, B.C. 1960.
32. Fields, Paul E., Donald E. Johnson, Gary L. Finger, Ronald J. Adkins, and Richard E. Carney, "A field test of the effectiveness of two intensities of shaded and unshaded lights in guiding downstream migrant salmon." Unpublished report. University of Washington, Technical Report No. 21:1-33. Seattle, Washington. March, 1956.
33. Link Belt Company, "Notes on travelling water screens." Based on a report made by Mr. Harvey Eastling. San Francisco, California. February 10, 1947.
34. Ruggles, C.P., and P. Ryan, "An investigation of louvers as a method of guiding juvenile Pacific salmon." The Canadian Fish Culturist, No. 33:7-68. November, 1964.
35. Smith, Keith A., "The use of air-bubble curtains as an aid to fishing." In "Modern Fishing Gear of the World," 2:540-544. Fishing News (Books) Ltd., London, E.C. 4. June, 1964. (Copyrighted. All rights reserved.)
36. Day, Dwane, E., "Population stratification and homing behavior in juvenile coho salmon (*Oncorhynchus kisutch*)." Washington Department of Fisheries, Fisheries Research Papers, 2(4):75-79. December, 1966.
37. Lethlean, N.G., "An investigation into the design and performance of electric fish screens and an electric fish counter." Royal Society of Edinburgh, Transactions, 62(13):479-526. 1951-1953.
38. Fields, Paul E., and Gary L. Finger, "The effectiveness of constant and intermittently flashing light barriers in guiding young silver salmon." Unpublished report. School of Fisheries, Technical Report No. 22. University of Washington, Seattle. March, 1956.
39. Bates, Daniel, and Stanley G. Jewett, "Louver efficiency in deflecting downstream migrant steelhead." Transactions of the American Fisheries Society, 90(3):336-337. July, 1961.
40. Canada Department of Fisheries, Fish Culture Development Branch, Pacific Area, "Progress report 1962 - summaries of current projects." Vancouver, B.C. May, 1963.
41. Regenthal, A.F., "Passage of downstream migrants over White River screens." Washington Department of Fisheries, Progress Report, Puget Sound Investigations, March through June 1953, pp. 102-103. Unpublished. Olympia, Washington. 1953.
42. McKernan, D.L., "A progressive report of experiments on the downstream migrating chinook salmon fingerlings at the Dryden ditch screens." Unpublished report. Washington Department of Fisheries, Olympia. 1940.
43. Thompson, John S., and G.J. Paulik, "An evaluation of louvers and bypass facilities for guiding seaward migrant salmonids past Mayfield Dam in Western Washington." Washington Department of Fisheries, Olympia, Washington. September, 1967.
44. Kleerekoper, Herman, "Olfaction in fishes." Indiana University Press, Bloomington. 1969. (No part of this book may be reproduced without permission in writing from the publisher.)
45. Quistorff, Elmer, "Floating salmon smolt collectors at Baker River dam." Washington Department of Fisheries, Fisheries Research Papers, 2(4):39-52. December, 1966.
46. Wales, J.H., E.W. Murphey, and J. Handley, "Perforated plate fish screens." California Fish and Game, 36(4):392-403. October, 1940.
47. Kupka, K.H., "A downstream migrant diversion screen." The Canadian Fish Culturist, Issue 37:27-34. August, 1966.
48. Andrew, F.J., L.R. Kersey, and P.C. Johnson, "An investigation of the problem of guiding downstream migrant salmon at dams." International Pacific Salmon Fisheries Commission, Bulletin No. VIII. New Westminster, B.C. 1955.
49. Hoard, C.L., and Clarence Giese, "Determination of the material most suitable for electrodes in fish guiding." Unpublished report. School of Fisheries, Technical Report No. 32:1-8. University of Washington, Seattle. August, 1956.

ARTIFICIAL GUIDANCE OF FISH

References Reviewed (Continued)

50. Gauley, Joseph R., "Effect of water velocity on passage of salmonids in a transportation channel." U.S. Fish and Wildlife, Fishery Bulletin, 66(1):59-63. January, 1967.
51. U.S. Fish and Wildlife Service, Pacific Salmon Investigations, "Effectiveness of a moving field of pulsating D.C. in directing salmon fingerlings: I. pulse frequency and pulse duration." Technical Progress Report No. 2 by Howard L. Raymond. Unpublished. Seattle, Washington. May, 1955.
52. Nakatani, Roy E., "The average specific electrical resistance of some salmonoids." Unpublished report. School of Fisheries, Technical Report No. 4, University of Washington, Seattle. 1954.
53. Aserinsky, Eugene, G.L. Hoard, Roy E. Natakani, and Leon A. Verhoeven, "Factors in pulsated direct current which cause electro taxis and side effects in young salmon." Unpublished report, School of Fisheries, Technical Report No. 5:1-12. University of Washington, Seattle. 1954.
54. Wickett, W.P., "Production of chum and pink salmon in a controlled stream." Fisheries Research Board of Canada, Progress Reports of the Pacific Coast Stations, No. 93:7-9. 1952.
55. Ericksen, Donald M., "Observations and experiments with fish screens in the Wenatchee River system." Unpublished. May, 1940.
56. Lancaster, D.M., and T.J. Rhone, "Field and laboratory tests to develop the design of a fish screen structure, Delta-Mendota Canal headworks, Central Valley Project, California." U.S. Bureau of Reclamation, Hydraulic Laboratory, Report Hyd.-401. March, 1955.
57. Hartley, W.G., "Powerstation cooling water intakes as a hazard to migrating salmon smolts." International Council for the Exploration of the Sea, Salmon and Trout Committee, Committee Minutes No. 151. 1965. (*This paper has been reviewed but the results have not been cited, in accordance with the author's request.*)
58. Oregon State Game Commission, "Marmot fish screen study." Unpublished. Portland. February, 1955.
59. Rietze, Harry L., "Yearling spring chinook losses at Marmot traveling screens from Bonneville, February 25 and 27, 1952 liberation." Unpublished. Oregon State Fish Commission, Portland. 1952.
60. Leitritz, Earl, "Stopping them: the development of fish screens in California." California Fish and Game, 38(1):53-62. January, 1952.
61. Chapman, Wilbert M., "Experiments with a revolving fish screen." Unpublished. Washington Department of Fisheries, Olympia. 1935.
62. Long, Clifford W., "Research on fingerling mortality in Kaplan turbines." U.S. Bureau of Commercial Fisheries, Biological Laboratory, Seattle, Washington. October, 1967.
63. "Tracy fisheries project: report on fish screen experiments at Coleman." 1952. (*Unpublished report in Milo C. Bell's file.*)
64. "The control of downstream migrants by means of mechanical screens." A report submitted by the Oregon State Game Commission to the U.S. Army Corps of Engineers, North Pacific Division, Progress Report, Fisheries-Engineering Program. Portland. November. 1956.
65. "Information bulletin fish passage fish facilities Bonneville Dam, Columbia River, Oregon and Washington." U.S. Army Corps of Engineers, Portland District. Report No. 66-1, compiled for Office of Chief of Engineers by Bonneville Hydraulic Laboratory, Portland. April, 1958.
66. Warner, George H., "Final report on activities at Contra Costa steam plant." Unpublished memorandum addressed to Bureau of Fish Conservation and Marine Fisheries, California Department of Fish and Game. Sacramento. October 1, 1952.
67. "Fish protection at the Tracy pumping plant." U.S. Department of the Interior, Bureau of Reclamation, Sacramento, California, and U.S. Fish and Wildlife Service, Portland, Oregon. 1957.
68. McMillan, F.O., "Electric fish screen." U.S. Bureau of Fisheries, Bulletin, 44(1):97-128. 1929.
69. Long, Clifford W., "First observations of hydraulic model studies of a traveling screen in an Ice Harbor turbine intake." Unpublished. U.S. Bureau of Commercial Fisheries, Pasco Biological Field Station, Pasco, Washington. March, 1969.
70. "Fish screen head loss--perforated 16-gage steel plate (5/32-inch holes staggered on 7/32-inch centers) versus 5-mesh, 19-gage galvanized wire--Tracy pumping plant intake--Central Valley project." U.S. Bureau of Reclamation, Research and Geology Division, Branch of Design and Construction, Hydraulic Laboratory report No. Hyd.-274. Denver, Colorado. March, 1950.
71. Prince, E.E., "Irrigation canals as an aid to fisheries development in the west." Transactions of the American Fisheries Society, 52:157-165. 1922.
72. Cheney, W.O., "Discussion of passage of rainbow trout through hydroelectric conduits." Pacific Gas and Electric Company, Bureau of Tests and Inspection, Technical Data. Unpublished. July, 1953.
73. "Fish screens." (Aitken revolving fish screen.) Oregon State Fish and Game Commission, Biennial Report, 1917:34. Portland. 1917.

ARTIFICIAL GUIDANCE OF FISH

References Reviewed (Continued)

74. U.S. Army Corps of Engineers, North Pacific Division, Fisheries Engineering Research Program, "The control of downstream migrants by means of mechanical screens." (Contributed by Oregon State Game Commission.) Portland. November, 1956. pp. 74-82.
75. Bostick, W.E., "Downstream migrant passage over White River screens." Washington State Department of Fisheries, Progress Report, Pubet Sound Stream Studies. Unpublished report. Olympia. 1955.
76. "Fish screens." (Mechanical rotary drum type.) Idaho Department of Fish and Game, Biennial Report, 24:44. Boise. 1950/1952.
77. Phillips, R.W., "The control of downstream migrants by means of mechanical screens." Unpublished report. Oregon State Game Commission, Portland. 1956.
78. Gordon, R.N., "Fisheries problems associated with hydroelectric development." The Canadian Fish Culturist, 35:17-36. October, 1965.
79. Burkey, Henry T., "Excerpts from a special report on some of the applications of the control of animal and vegetable forms of life in water by the use of electric currents." Unpublished. Hollywood, California. July, 1960.
80. Wales, J.H., "California's fish screen program." California Fish and Game, 34(2):45-51. April, 1948.
81. Spencer, John, "Fish screens in California irrigation ditches." California Fish and Game, 14(3):208-210. July, 1928.
82. Fields, Paul E., A. Keith Murray, Donald E. Johnson, and Gary L. Finger, "Guiding migrant salmon by light repulsion and attraction in fast and turbid water." Unpublished report. College of Fisheries, Technical Reports 36 and 41. University of Washington, Seattle. February, 1958.
83. U.S. Army Corps of Engineers, North Pacific Division, Fisheries-Engineering Research Program, "The effect of sound waves on young salmon." (Contributed by U.S. Fish and Wildlife Service.) Portland. pp. 27-41. November, 1956.
84. International Garrison Diversion Study Board, Appendix C: Biology, J. Loch and D.H. Henegar, Co-chairmen, Canada-United States International Joint Commission, International Garrison Diversion Study Board, Bureau of Reclamation, Denver, Colorado, R691-15-(8-61), 392 p. 1976.
85. Miller, R., "Systematics and biology of the gizzard shad (*Dorosoma cepedianum*) and related species." U.S. Fish and Wildlife Service Fishery Bulletin 173:371-392. 1960
86. Graham, R., "Biology of the Utah chub in Hibgin Lake, Montana." Transactions of the American Fisheries Society, 90:269-276. 1961.
87. Tagart, J., "The survival from egg deposition to emergence of coho salmon in the Clearwater River, Jefferson County, Washington." M.S. Thesis, University of Washington, Seattle, 101 p. 1976.
88. Rupp, R., "Variations in the life history of the American smelt in inland waters of Maine." Transactions of the American Fisheries Society, 88:241-252. 1959.
89. Rothschild, B., "Production and survival of eggs of the American smelt, *Osmerus mordax* (Mitchell), in Maine." Transactions of the American Fisheries Society, 90:42-48. 1961.
90. Bailey, M., "Age, growth, maturity and sex composition of the American smelt, *Osmerus mordax* (Mitchell), of western Lake Superior." Transactions of the American Fisheries Society, 93:382-395. 1964.
91. Purkett, C., Jr., "Reproduction and early development of the paddlefish." Transactions of the American Fisheries Society, 90:125-129. 1961.
92. Unkenholz, D., "Investigation of paddlefish populations in South Dakota and development of management plans, 1976." Dingell-Johnson Project F-15-R-12, Study Number IX, Jobs 3, 5, and 7, South Dakota Department of Game, Fish, and Parks, Division of Game/Fish, 19 p. 1976.
93. Echelle, A., and C. Riggs, "Aspects of early life history of gars (*Lepisosteus*) in Lake Texoma." Transactions of the American Fisheries Society, 101:106-112. 1972.
94. Trautman, M., "The Fishes of Ohio." Ohio State University Press, Waverly Press, Inc., Baltimore, Maryland, 683 p. 1957.
95. Mansueti, A., and J. Hardy, "Development of fishes of the Chesapeake Bay region: an atlas of egg, larval, and juvenile stages." Part 1, National Research Institute, University of Maryland, Baltimore, 202 p. 1967.
96. McPhail, J., and C. Lindsey, "Freshwater fishes of northwestern Canada and Alaska." Bulletin 173, Fisheries Research Board of Canada, Ottawa, 381 p. 1970.
97. Scott, W., and E. Crossman, "Freshwater fishes of Canada." Bulletin 184, Fisheries Research Board of Canada, Ottawa, 966 p. 1973.
98. Electric Power Research Institute, "Assessment of downstream migrant fish protection technologies for hydroelectric application." Prepared by Stone & Webster Engineering Corporation. Research Project 2694-1. Final report. Electric Power Research Institute, 3412 Hillview Avenue, Palo Alto, California. September, 1986.
99. Burner, C.J., and H.L. Moore, "Attempts to guide fish with underwater sound." SSR-F 403. U.S. Department of Interior, Fish & Wildlife Service, Seattle, Washington. February, 1962.
100. Electric Power Research Institute, "Hydraulic Model Evaluation of the Eicher Passive Pressure Screen Fish Bypass System." Prepared by Eicher Associates, Inc.. EPRI AP 5492 Project 1745-18. Final Report. Portland, Oregon. October 1987.

Chapter 27

Artificial Spawning Channels

Used as alternatives.

Two general types: upwelling and stream.

Temperature, oxygen and pollution affect artificial spawning channels.

Normally permit greater percolation rate and higher survival of eggs to fry.

Barrier dam or lead required.

General design criteria for channel given.

Gravel sizes and hydraulic criteria given.

A. Stream-Type Spawning Channel.

B. Upwelling-Type Artificial Spawning Area.

C. Plan-Typical Layout.

References Reviewed.

ARTIFICIAL SPAWNING CHANNELS

Artificial man-made spawning channels may be used as alternatives to hatcheries. They are scattered generally from northern California to northern British Columbia, and are currently used for the production of chinook, sockeye, pink and chum salmon. There are two general types: upwelling and stream. Sockeye, with lake-spawning characteristics, use the upwelling type. Other species prefer the stream type. Exhibits A and B give general cross sections of the two types.

Natural factors, as temperature, oxygen and pollution, affect artificial spawning channels. As constructed, they normally permit a greater percolation rate and, hence, a higher survival rate of eggs to fry. Because of this factor, fry may emerge earlier in artificial spawning channels than do their counterparts in natural stream beds. As the beds age, silt may close the voids, requiring the cleaning of the beds to increase production. If possible, bed load should be removed from the spawning channel's flow. Spawning activity frequently begins at the edges of the channels or near the controls. Eggs may be hand-planted but high density plants are not recommended.

To introduce fish into artificial spawning channels, a barrier dam or some other method of providing a lead may be required. See Chapter 26, "Artificial Guidance of Fish," for barrier dam details.

Exhibit C gives a possible layout for an artificial spawning channel and pertinent structures that may be required.

Fish will return to spawning channels if properly imprinted.

Individual channels vary but the following criteria indicate the general design limits currently in use.

Widths - 12 to 40 feet.

Channels are designed to provide for:
counting of adults into area;
drying for maintenance and fry removal;
screens at upper end for predator control;
settling basins for silt removal.

Flood flows - use 5 feet per second in bank protection design.

General lengths of bed segments - up to 1,000 feet with a control for each segment.

Gravels:

spawning bed - 80 percent 1/2 inch to 1-1/2 or 2 inches;
balance up to 4 inches,
under-bed - 2 feet coarse (3 inches plus) gravel.

Hydraulic criteria:

velocity average = 1.5 feet per second
depth = 1.5 feet during spawning times
slope = .0006
roughness = $n = .025-.030$
percolation rate = 1,100 mm/hr
spawning flows = 2.25 cfs per foot of mean width
incubation flows = ≥ 1.5 cfs per foot of mean width
fry removal flows = 3.0+ cfs per foot of mean width

General:

various species have different day-degree requirements for egg and fry development.
125-200 eggs per square foot of bed
egg depth in gravel - 3 inches to 12 inches
females live approximately 10 days after spawning
survival rate (egg to fry) 40-60 percent average
(up to 95 percent reported)
fry size - close to that of fry hatched in natural streams

(See Chapter 19, "Hatcheries," and Chapter 20, "Rearing Ponds," for time in gravel. See Chapter 7, "Spawning Criteria," for redd sizes.)

ARTIFICIAL SPAWNING CHANNELS

A Stream-Type Spawning Channel

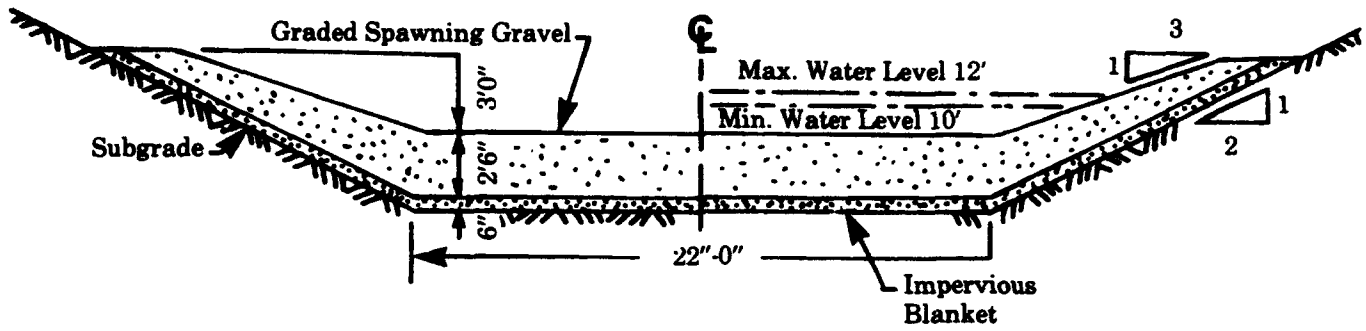

Spawning Channel with Stabilized Side Slopes

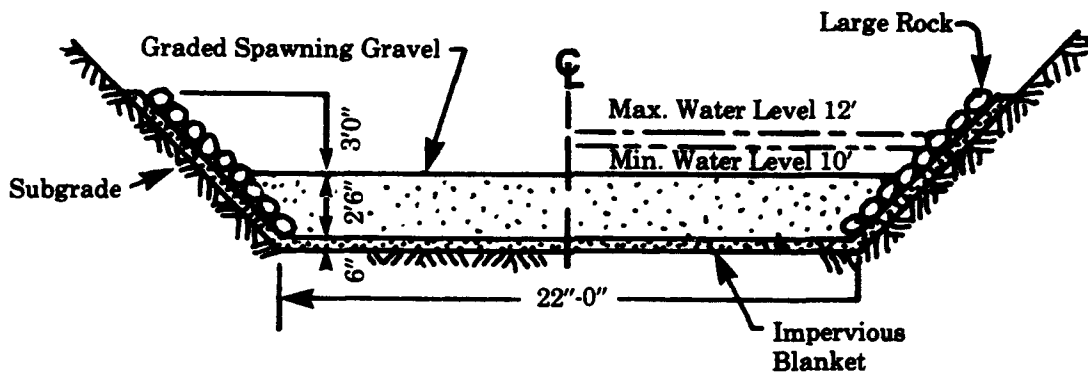

B Upwelling-Type Artificial Spawning Area

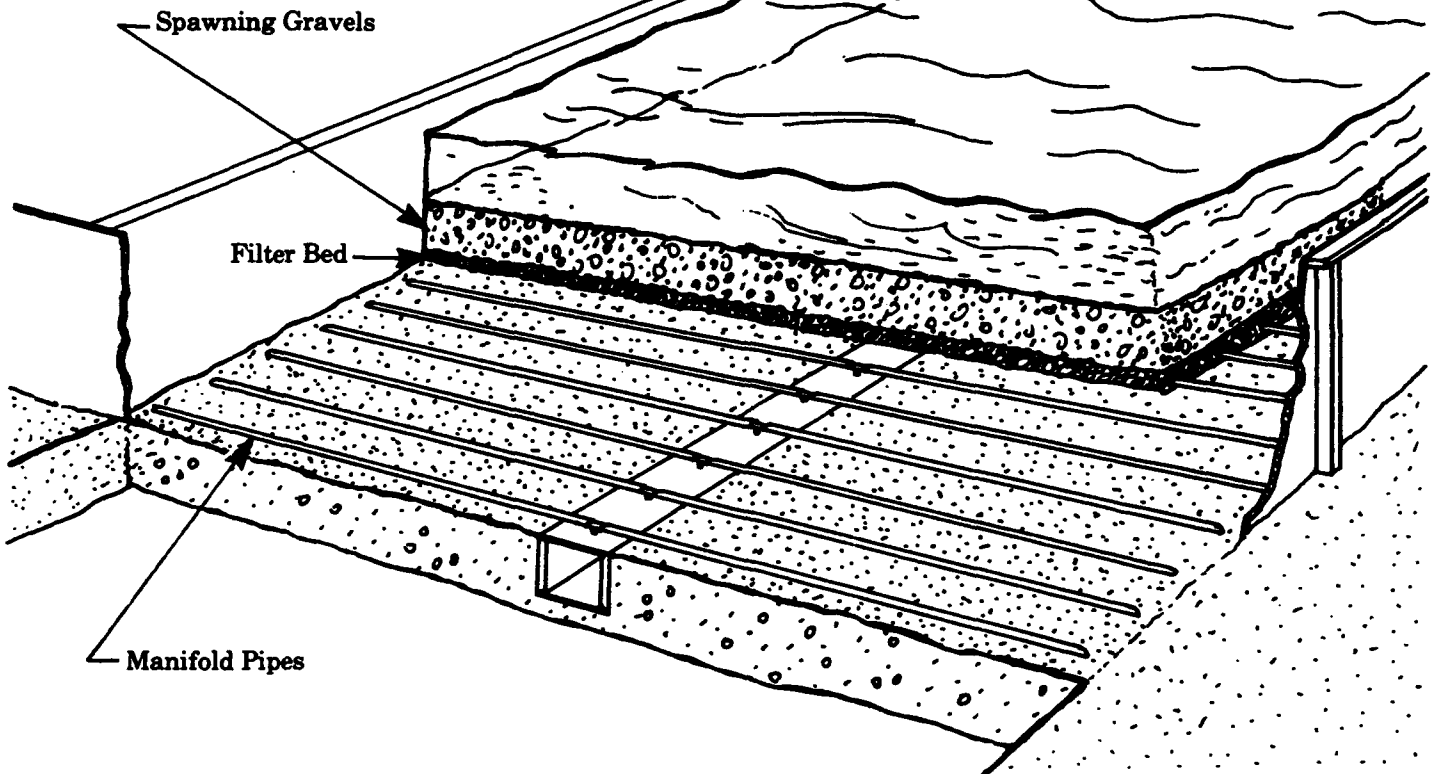

ARTIFICIAL SPAWNING CHANNELS

C

Plan - Typical Layout

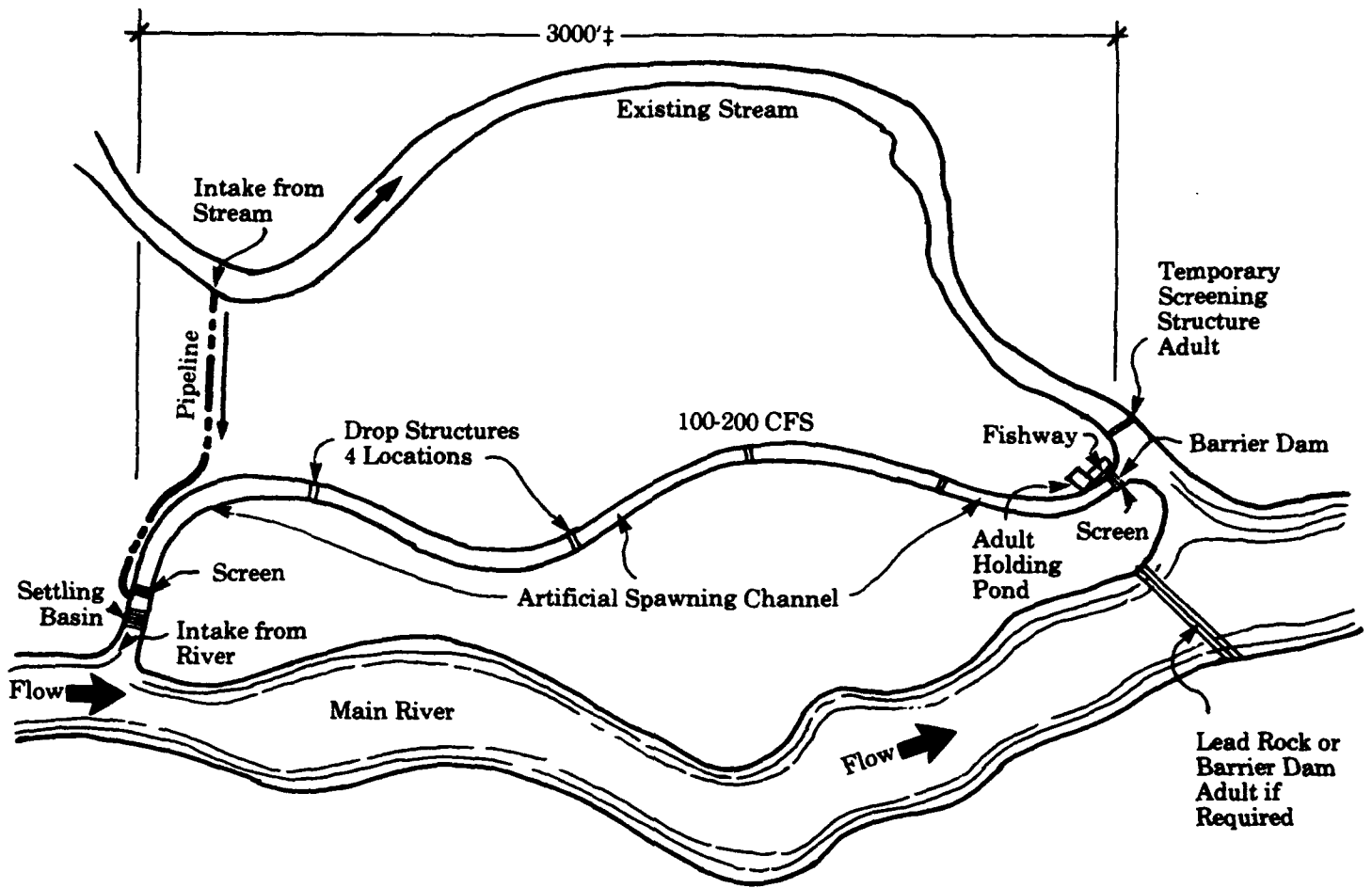

ARTIFICIAL SPAWNING CHANNELS

References Reviewed

1. Mead, R.W., and W.L. Woodall, "Comparison of sockeye salmon fry produced by hatcheries, artificial channels and natural spawning areas." International Pacific Salmon Fisheries Commission, Progress Report No. 20. New Westminster, B.C. 1968.
2. International Pacific Salmon Fisheries Commission, "Proposed artificial spawning channel for Weaver Creek sockeye salmon." New Westminster, B.C. 1964.
3. Canada Department of Fisheries, "Big Qualicum River biological survey, 1960-1961." Vancouver, B.C. September, 1962.
4. Hourston, W.R., and D. MacKinnon, "Use of an artificial spawning channel by salmon." Transactions of the American Fisheries Society, 86:220-230. 1956.
5. Chambers, J.S., and A.C. Moser, "Annual report 1961-62: production of fall chinook salmon in the Rocky Reach spawning channel." Washington Department of Fisheries, Olympia, Washington. July, 1962.
6. MacKinnon, D., "A successful transplant of salmon eggs in the Robertson Creek spawning channel." The Canadian Fish Culturist, Issue No. 27:25-31. August, 1960.
7. International Pacific Salmon Fisheries Commission, "Proposed artificial spawning channel for Gates Creek sockeye salmon." New Westminster, B.C. 1966.
8. Chambers, John S., "Research relating to McNary supplemental spawning channel, July 22, 1957 to July 22, 1958." Washington Department of Fisheries, Annual Report submitted to U.S. Army Corps of Engineers, Contract No. DA-35-026-Civeng-58-23. Olympia, Washington. 1958.
9. Thomas, Allan E., and J.M. Shelton, "Operation of Abernathy Channel for incubation of salmon eggs." U.S. Fish and Wildlife, Bureau of Sport Fisheries, Technical Paper No. 23. June, 1968.
10. Lucas, K.C., "The Robertson Creek spawning channel." The Canadian Fish Culturist, Issue No. 27:3-23. August, 1960.
11. Webb, Russell D., "Mannings 'n' roughness coefficients in a shallow open channel." Unpublished report for Washington Department of Fisheries, Olympia, Washington. No date.
12. Shelton, Jack M., "The hatching of chinook salmon eggs under simulated stream conditions." The Progressive Fish-Culturist, 17(1):20-35. January, 1955.
13. Pollack Robert D., "Tehama-Colusa canal to serve as spawning channel" The Progressive Fish-Culturist, 31(3):123-130. July, 1969.
14. McDonald, J.G., "Distribution, growth and survival of sockeye fry (*Oncorhynchus nerka*) produced in natural and artificial stream environments." Fisheries Research Board of Canada, Journal, 26(2):229-267. February, 1969.
15. Broad, Robert D., and Harold A. Gangmark, "Establishment of a controlled flow area and construction of king salmon spawning pens at Mill Creek, California." The Progressive Fish-Culturist, 18(3):131-134. July, 1956.
16. MacKinnon, D., L. Edgeworth, and R.E. McLaren, "An assessment of Jones Creek spawning channel, 1954-1961." The Canadian Fish Culturist, Issue No. 30:3-14. December, 1961.
17. Shapovalov, Leo, "Experiments in hatching steelhead eggs in gravel." California Fish and Game, 23(3):208-214. July, 1937.
18. "Annual report, 1964." Canada Department of Fisheries, Fish Culture Development Branch, Pacific Area, Vancouver, B.C. May, 1965.
19. Wickett, W.P., "Production of chum and pink salmon in a controlled stream." Fisheries Research Board of Canada, Progress Report 93:7-9. 1952.
20. Shapovalov, Leo, and William Berrian, "Experiment in hatching silver salmon (*Oncorhynchus kisutch*) eggs in gravel." Transactions of the American Fisheries Society, 69:135-140. 1939.
21. Meekin, Thomas K., "McNary supplemental spawning channel, summary report 1957 through 1966." Washington State Department of Fisheries Research Division, U.S. Army Corps of Engineers, NPD, Contract No. DA45-164-Civeng-65-4. September, 1967.
22. Fraser, J.C., "Regulated stream discharge for fish and other aquatic resources - an annotated bibliography." Food and Agriculture Organization of the United Nations, FAO Fisheries Technical Paper No. 112. September, 1972.

Chapter 28

Predation

Occurrence in same species due to size difference.

Menace of squawfish and suggested control.

Effect of turbidity.

Effect of bypasses.

Menace of fish-eating birds and aquatic mammals.

Suggested method for controlling predator populations.

References Reviewed.

PREDATION

Predation occurs to some extent throughout the life cycle of most species of fish, and is a significant factor in their rate of survival and abundance. It is considered advantageous to reduce the rate of predation on the economically important food and sports fish species.

Predation often occurs among fish of the same species, because of size difference. It is beneficial in salmonoid cultural operations to size-grade the ponded fingerlings at frequent intervals to prevent cannibalism and fin damage and to promote even growth.

Predation is of particular concern with anadromous species, and chiefly with salmon and steelhead trout. There is little or no control over predation that occurs during their ocean residence, which constitutes a considerable portion of their life cycle. Measures are increasingly being adopted to reduce the extent of freshwater predation, particularly in fingerling stage. Fish that are ready to migrate at release from hatcheries show less evidence of predation and a higher survival than smaller fingerlings that remain in schools in shallow water after release.

The greatest source of predation to salmon and trout is other species of fish, such as squawfish (*Ptychocheilus oregonensis*). Extensive field studies by the National Marine Fisheries Service and U.S. Fish and Wildlife Service have shown the range and extent of squawfish depredation and have resulted in recommendations for partial control measures by netting, electric shocking and the use of fish toxicants. (See Chapter 17, "Fish Toxicants.")

In the Columbia River, squawfish seining operations at hatchery release points showed large number of these fish to be present, and squawfish stomach analyses showed large numbers of salmon and fingerlings consumed.

Squawfish are a menace to young salmonids, particularly in reservoirs and slack water areas. It has been noted that they congregate around hatchery discharge drains, where they feed on waste hatchery food and refuse. Unless these fish can be easily eradicated, it is not advisable to release salmonoid fingerlings at such locations. It is preferable to liberate them a sufficient distance from a hatchery to avoid predator concentration. It has been observed that when several liberations of salmon fingerlings are made at the same location at frequent intervals over a number of hours, a concentration of these fingerlings occurs in the area before the last release of fish has had an opportunity to disperse downstream. This also leads to a concentration of squawfish in the same area and extensive predation.

Suggested basin-wide control measures for squawfish can include their segregation and trapping in the fishways.

Trucking or barging of hatchery-produced salmon fingerlings downstream, at least past obstructions, is advantageous in avoiding predators, but may interfere to some extent with homing.

In one large segment of fish culture concerned with the production of warmwater species, such as largemouth bass, predation is controlled by removal of the bass fry from the brood ponds to prevent cannibalism. However, in this

type of fish culture, a predator-prey relationship is essential. As soon as the young bass approach the size where they can capture other fish (within their first year), forage fish are introduced into the pond in the proper ratio. In fertilized ponds this ratio generally is 700-1000 bluegill or other sunfish fingerlings to 100 largemouth bass fingerlings per surface acre. Unfertilized ponds are stocked at one-half these numbers.

A similar predator-prey relationship is essential to some trout fisheries; for example, the Kamloops trout production in Lake Pend d'Oreille is possible only because of their predation on the Kokanee.

Turbidity usually is considered detrimental to fish, but it offers a measure of protection to salmonoid fingerlings by making them less visible to predators, both fish and birds.

Downstream migrants stunned or injured by stresses are more vulnerable to predators, both fish and birds. Fish directed into bypasses by screens or diverting channels also may be subjected to unusual predation by being concentrated at a point of delivery into the main river. Alternating the delivery areas will avoid this type of predation.

Another source of predation on young salmon and trout is fish-eating birds. These include a wide variety of species. Some of the worst offenders descend in a flock on fish concentrated in shallow ponds. This type of predation is not usually a serious problem under natural environmental conditions. Mergansers, kingfishers, gulls and blue herons along a stream take some toll of fish, but their diet includes rough fish as well as salmonids. At hatcheries with rearing ponds on the station, or adjacent to other facilities, some protection against birds can be provided by nets or interlaced ropes placed above the ponds.

Other predators are aquatic mammals, such as hair seals, mink, otter, bears and sea lions. These usually prey on adult fish.

Predation by sea lampreys has occurred in serious proportions in the Great Lakes, requiring extensive efforts to control the populations by the use of electricity and specific toxins. See Reference No. 16 of Chapter 17, "Fish Toxicants."

A method used in controlling predator populations is by changing the water levels at critical times of spawning and hatching of the predator species involved. In this manner, eggs of predators may be exposed and killed by drying.

As temperature levels are a major factor in survival, fluctuating temperatures may be used to separate species.

Delays in normal movement pattern add to predation losses. Such delays can occur upstream from hydroelectric plants, at trash rack bars, and by disorientation of the fish at the time of planting.

Predators may use sheltered areas of low velocity to attack small fish moving in an active current. Such areas should not be available in collection areas and bypasses.

Light and shadow paths are utilized by predators advantageously.

PREDATION

References Reviewed

1. Mead, R.W., and W.L. Woodall, "Comparison of sockeye salmon fry produced by hatcheries, artificial channels, and natural spawning areas." International Pacific Salmon Fisheries Commission, Progress Report 20. New Westminster, B.C. 1968.
2. Shetter, David S., and Gaylord R. Alexander, "Results of predator reduction on brook trout and brown trout in 4.2 miles (6.76 km) of the north branch of the Au Sable River." Transactions of the American Fisheries Society, 99(2):312-319. April, 1970.
3. Michimoto, Raymond T., and Lawrence Korn, "A study to determine the value of using the ice-trash sluiceway for passing downstream-migrant salmonoids at Bonneville Dam." Final report to U.S. Army Corps of Engineers, Contract No. DACW-57-69-C-0099. Oregon Fish Commission, Portland. September, 1969.
4. Jeppson, Paul, "The control of squawfish by use of dynamite, spot treatment, and reduction of lake levels." The Progressive Fish-Culturist, 19(4):168-171. October, 1957.
5. Shields, James T., "Experimental control of carp reproduction through water drawdowns in Fort Randall, South Dakota." Transactions of the American Fisheries Society, 87:23-33. 1957.
6. Hamilton, J.A.R., L.O. Rothfus, M.W. Erho, and J.D. Remington, "Use of a hydroelectric reservoir for the rearing of coho salmon (*Oncorhynchus kisutch*)." Washington State Department of Fisheries, Research Bulletin 9. Olympia. April, 1970.
7. Allen, K. Radway, "The Horokiwi stream: a study of a trout population." New Zealand Marine Department of Fisheries Bulletin 10:1-231. 1951.
8. Chambers, John S., "Research relating to McNary supplemental spawning channel, July 22, 1957 to July 22, 1958." Washington State Department of Fisheries, Annual Report to U.S. Army Corps of Engineers, Contract No. DA 35-026-Civeng-58-23. Olympia. 1958.
9. Long, Clifford W., "Proposed research on the development of the gatewell-sluice method of bypassing fingerlings around the turbines." Unpublished. U.S. Bureau of Commercial Fisheries, Biological Laboratory, Seattle, Washington. June, 1968.
10. Smith, M.W., "Fertilization and predator control to improve trout angling in natural lakes." Fisheries Research Board of Canada, Journal, 12(2):210-237. March, 1955.
11. Larkin, P.A., and J.G. McDonald, "Factors in the population biology of the sockeye salmon of the Skeena River." The Journal of Animal Ecology, 37(1):229-258. February, 1968.
12. Angstrom, Richard L., and Paul E. Reimers, "Occurrence of juvenile salmon in stomachs of adult coho salmon." Oregon Fish Commission, Research Briefs, 10(1):69. June, 1964.
13. Wright, Lloyd, "Forage size preference of the largemouth bass." The Progressive Fish-Culturist, 32(1):36-42. January, 1970.
14. Davis, Robert M., "Parasitism by newly-transformed anadromous sea lampreys on landlocked salmon and other fishes in a coastal Maine lake." Transactions of the American Fisheries Society, 96(4):424-430. October, 1967.
15. McPhail, J.D., "Predation and the evolution of a stickleback (*Gasterosteus*)." Fisheries Research Board of Canada, Journal, 26(12):3183-3208. December, 1969.
16. Coche, Andre' G., "Production of juvenile steelhead trout in a freshwater impoundment." Ecological Monographs, 37(3):201-228. Summer, 1967.
17. Zimmer, Paul D., "A note about squawfish." The Progressive Fish-Culturist, 29(1):35. January, 1967.
18. Clemens, W.A., and J.A. Munro, "The food of the squawfish." Fisheries Research Board of Canada, Progress Reports of the Pacific Coast Stations, 19:3-4. 1934.
19. Thompson, Richard B., "A study of localized predation on marked chinook salmon fingerlings released at McNary Dam." Washington State Department of Fisheries, Fisheries Research Papers, 2(2):82-83. April, 1959.
20. Burck, Wayne A., "Occurrence of small chinook salmon in stomachs of spent adult chinook salmon." Oregon Fish Commission, 11(1):51. Portland. June, 1965.
21. Williams, I.V., and P. Gilhousen, "Lamprey parasitism on Fraser River sockeye and pink salmon during 1967." International Pacific Salmon Fisheries Commission, Progress Report 18. New Westminster, B.C. 1968.
22. Thompson, Richard B., and Dennis F. Tufts, "Predation by Dolly Varden and northern squawfish on hatchery-reared sockeye salmon in Lake Wenatchee, Washington." Transactions of the American Fisheries Society, 96(4):424-430. October, 1967.
23. Rose, Earl T., and Tom Moen, "The increase in gamefish populations in East Okoboji Lake, Iowa, following intensive removal of rough fish." Transactions of the American Fisheries Society, 82:104-114. 1952.
24. Smith, M.W., "Observations of fish-eating birds and mammals at Crecy Lake, New Brunswick, over a 12-year period." The Canadian Fish Culturist, Issue 39:41-46. January, 1967.

Chapter 29

Recovery Gear

Fyke nets, description and use.

Effectiveness of gill nets.

Beach seine value.

Traps and pound nets.

Plankton nets.

Weirs.

Photo aids.

Fish wheels.

Electric fish collectors.

Fixed Trap Net.

A. Fish Wheel, Floating Trap Net.

B. Inclined-Plane Screen Trap,
Fyke Net (Side View).

References Reviewed.

RECOVERY GEAR

Various types of nets, traps and other gear are used in collecting fish for study. Each is adapted for use under specific conditions.

Fyke Nets

Fyke nets have been used in Europe for centuries. In the Pacific Northwest they have been used for sampling downstream migrants of anadromous species. They are not without limitation because of the relatively small amount of water that they strain. They may be either stationary or used as tow or push nets. (Exhibit B) Stationary fyke nets may be provided with wings or a lead, or both. The size of opening of both the mouth and mesh varies widely. The mesh size may decrease toward the small or cod end of the net. Each of the several sections of the net is supported by a frame or hoop, which also supports an inner funnel-shaped throat. A typical pyramidal-shaped fyke net might be 10 feet long and 4 feet square at the mouth, with a 1/4 or 3/16 stretch mesh knotless webb in the fyke section, and 1/2 inch stretch mesh in the wings and lead. (Exhibit B)

A common problem with fyke nets is that unless located in clean water they may rapidly become plugged and the amount of water strained through them may be greatly reduced. Such variability introduces bias with numbers of fish collected and their sizes; therefore, they are often of doubtful quantitative value in recovering fish unless checked at frequent intervals by means of a flow meter at the mouth. Another difficulty is that stationary fyke nets fish only limited areas, and therefore their location is of primary importance in obtaining true samples. The movable fyke net, either tow or push, overcomes the fixed position objection but is most effectively fished at or near the surface as it is difficult to hold at fixed levels or horizontal positions. It is selective for various sizes of free-swimming organisms, depending on the towing speed.

The velocity in which a fyke net is set or towed must be greater than the sustained speed of the fish to be captured. Depending on the relative size of the mesh opening, the velocity in the throat of the net is less than the surrounding velocities. In using these nets, the swimming speed of the animal and its size should be known, and the head loss through the meshes should be known or calculated to determine the approach velocity to the throat. As mentioned, debris is a problem. (See Chapter 6, "Swimming Speeds of Adult and Juvenile Fish.")

Gill Nets

A useful tool in fisheries management is the experimental gill net, which will capture a wide variety of species and sizes of fish. A typical experimental gill net may consist of five 25-foot sections of nylon mesh, ranging from 1/2 inch square mesh at one end to 1-1/2 inch square mesh at the other end. It is usually 6 feet deep for surface fishing, or at the level where fish are expected to occur, and is weighted and anchored at the bottom and buoyed at the top so as to hang nearly vertical, and laid in a straight line. It is most effective at night, and particularly on dark moonless nights, when the mesh is less visible or invisible to the fish.

Beach Seines

Another useful fishery management tool is the beach seine. This is used extensively in warm water fishery studies in ponds and lakes, as well as in other suitable areas that are free from snags, large rocks and heavy floating

debris, and high velocities. It may be used for population sampling and, on a larger scale, for reduction of overpopulations, and for salvage and transfer of fish populations. The beach seine is not as harmful to fish as a gill net. It is usually of uniform mesh size, with the mesh opening depending on species and size of fish for which it is used. It is most useful in shallow water.

The normal operating procedure is for one end of the net to be held on shore and the other end to be laid out on an arc and brought back to shore. The lead line and float line then are gradually brought in together, care being taken to keep the lead line on the bottom.

A variation of the beach seine is the bag seine, which is similar but with the addition of a bag section in the center that aids in retaining large numbers of fish.

Traps and Pound Nets

Floating trap nets are useful in some situations, such as fish salvage work or for reducing undesirable fish populations. The pirate trap net, developed in the Great Lakes area, may be set quickly, has effective wings, and is useful in quiet or slow-moving water areas. (Exhibit A)

Pound nets usually are staked out with a lead, a pot and a spiller, all open at the top.

The California type of cylindrical trap net is similar to a large fyke net, and is easily rolled into position and removed.

The inclined-plane trap is an effective means of catching and holding downstream migrants without excessive injury to the fish. (Exhibit B) Another version, the fixed inclined-plane trap, dissipates the water flowing in a downstream direction, with the live box at the base. Only a small portion of the water enters the box, the rest being passed through a screened or louvered surface.

Plankton Nets

Plankton nets are somewhat similar in shape to conical fyke nets, but are usually smaller and are without wings or framework, except at the mouth. They are without inner fykes. They are typically made of finely woven silk or nylon bolting cloth. The mesh size must be chosen with respect to the size of the organisms to be captured; otherwise, these nets can be highly selective.

Some plankton nets, as the Clarke-Bumpus net, may be opened and closed at predetermined depths, and the amount of water strained in a given period may be calculated by means of an attached flow meter.

The fine weave of the detachable cod ends of these nets is limited only by the specific requirements for reasonable strength and durability.

Weirs

The use of stream weirs long has been an effective means of catching or enumerating anadromous fish. Indians formerly used V-shaped brush and willow weirs in conjunction with basket traps to take salmon.

Weirs may be provided with downstream traps, such as the inclined-plane type, for catching downstream migrant fingerlings.

RECOVERY GEAR

Weirs may be either of temporary or permanent construction. They are best adapted to small and medium size streams. By the nature of their construction, they should be constantly attended; otherwise, excessive injuries result.

Electric weir devices have been tried, usually with only limited success. Generally, these consist of a series of spaced vertical electrodes across a stream. (See Chapter 26, "Artificial Guidance of Fish".) There is some experimental evidence to indicate that the amount of electricity necessary to stop or divert salmon in their repeated attempts to pass an electric barrier can cause injury.

Photo Aids

The development of scuba diving and underwater photographic equipment in recent years, including infrared film, has made possible observations of fish in natural habitat.

Closed circuit television cameras, underwater photography and electronic fish counters are in use and improvements continue to be made. Light source and its intensity and dispersion is a major factor in identifying or recognizing individuals.

Fish Wheel

Fish wheels have been used commercially for capturing adults, both as fixed and movable gear. They have been adapted to today's use for capturing adults for experimental purposes. A floating adaptation is shown on Exhibit A.

The wheel is activated by the current. The fish are scooped and delivered through a chute to a trap or box. Their effectiveness has been increased by the use of leads and curtains.

As all such gear, they are subject to damage by debris, and should be given at least daily attendance.

Electric Fish Collectors

Improvements have continued to be made in the application of electricity to fish sampling methods in recent years. Battery-powered, back-pack units have been developed for use in streams. Larger, more versatile generating units have been developed for use in boats, with converters for either alternating or direct current. Electric fish shockers are most effective in hard or alkaline waters that have good conductivity, and are unsatisfactory in soft waters. In small streams their efficiency is enhanced by placing a block of cattle salt upstream a short distance from

the shocker, thus providing an electrolyte. Most fishery field workers now prefer variable-voltage, direct-current pulsators. Direct current, which is less damaging, has the distinct advantage of directing a fish toward the anode by locking it in a curved position. Alternating current, particularly with a higher gradient along the fish's body, causes a more violent contraction of the large dorsal muscle, which often causes injury or death by crushing the spinal column.

The fish's mobility is impaired at a voltage level of .5 V per cm or approximately 12.25 V per inch. Equilibrium is lost at 2.5 V per inch. Pulse rate is equally important and should be above 10 pulses per second. A higher pulse rate increases effectiveness of the current.

Most collectors, including electric shocking methods, have biases. Involved is the swimming capability of the fish to be recaptured, which is a function of body length, as is the effect of electric currents relative to volts per inch applied to various lengths of fish in the same field. When mesh is used, the size chosen may allow small fish to pass through the webbing.

Fixed Trap Net

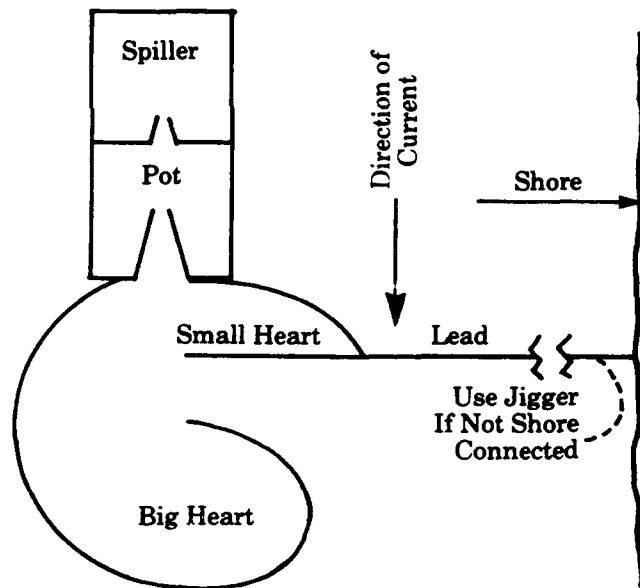

RECOVERY GEAR

A

Fish Wheel

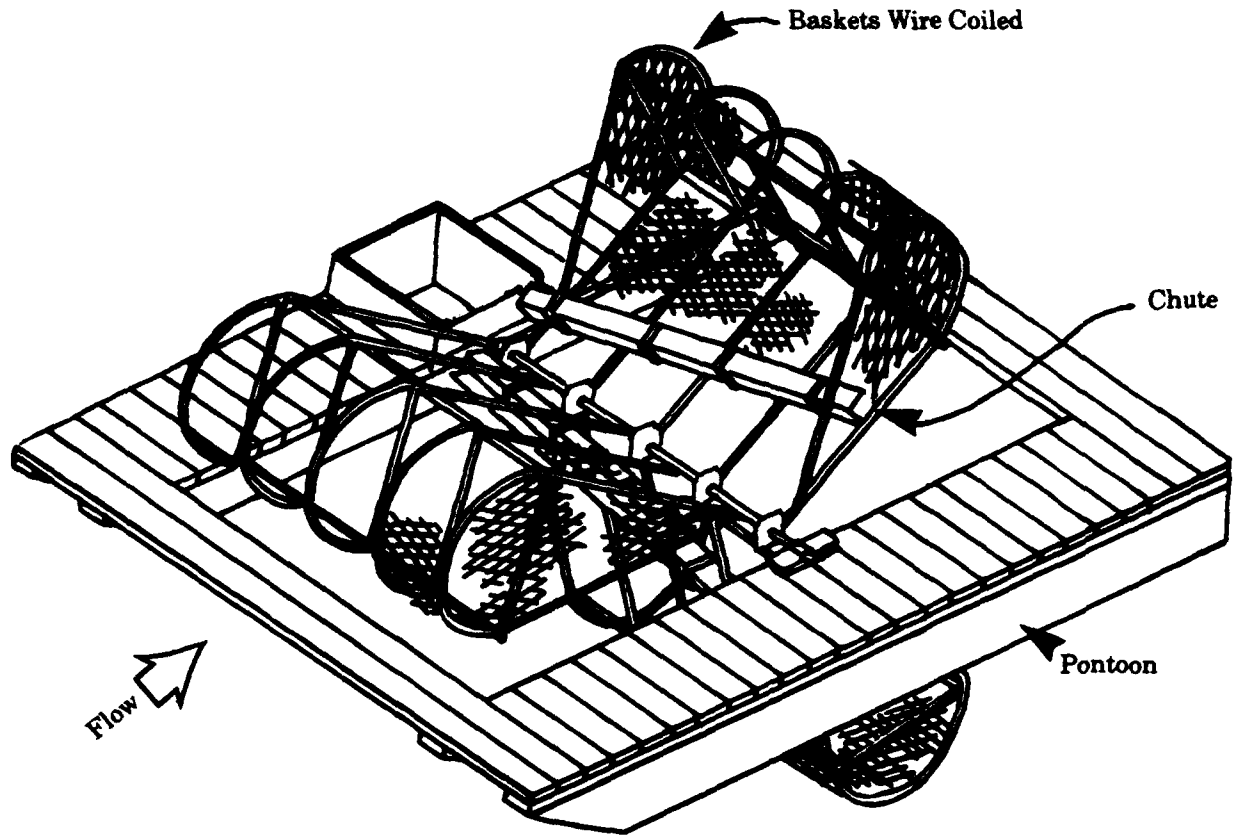

Floating Trap Net

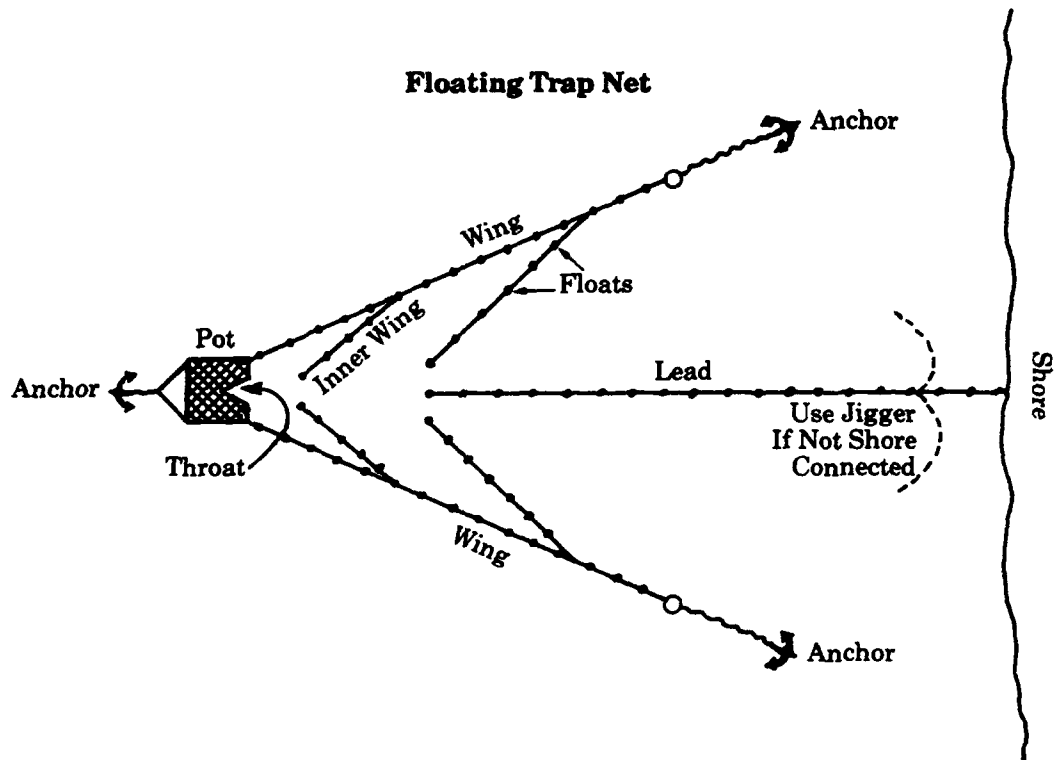

RECOVERY GEAR

B

Inclined-Plane Screen Trap

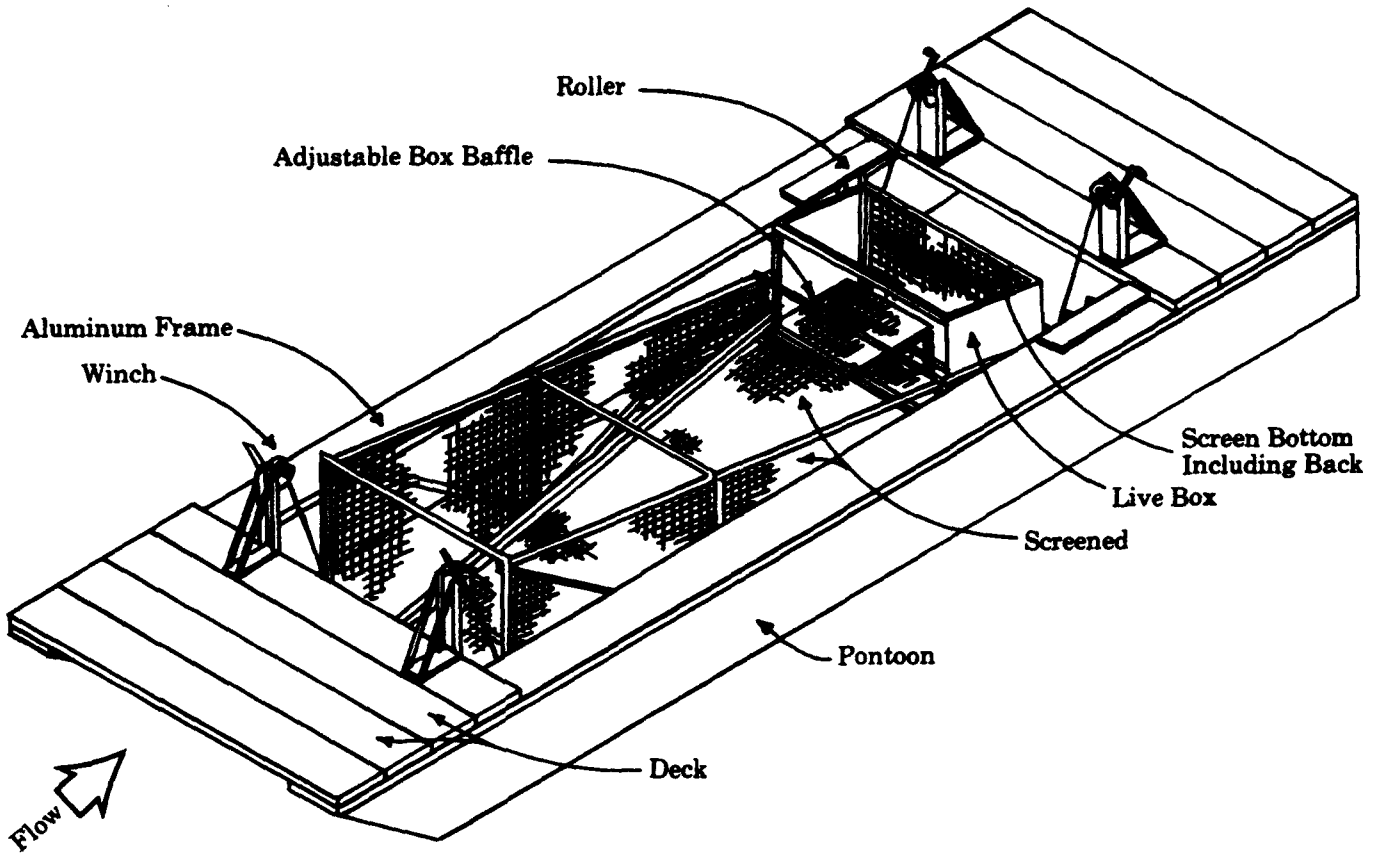

Fyke Net (Side View)

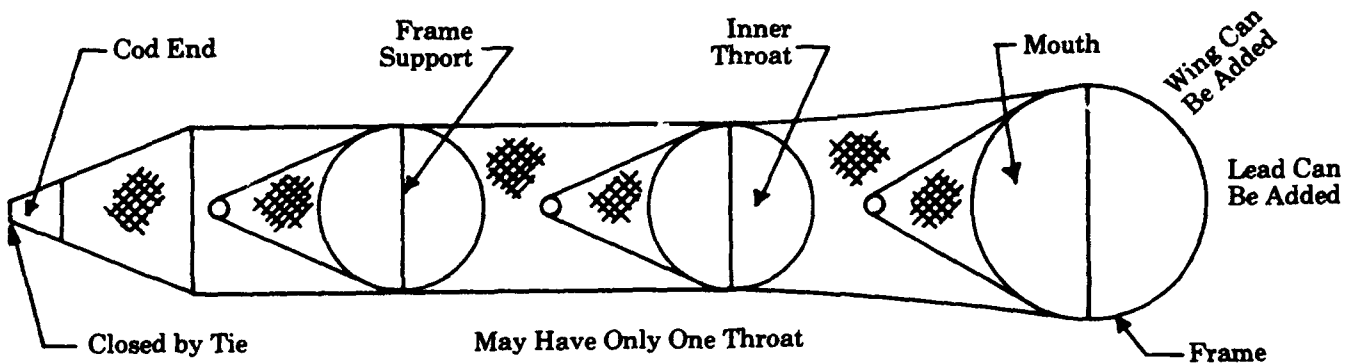

RECOVERY GEAR

References Reviewed

1. Hunter, Charles J., and Winston E. Farr, "large floating structure for holding adult Pacific salmon (*Oncorhynchus* spp.)" Fisheries Research Board of Canada, Journal, 27(5):947-950. May, 1970.
2. Tait, Howard D., Jerry L. Hout, and Fredrik V. Thorsteinson, "An evaluation of fyke trapping as a means of indexing salmon escapements in turbid streams." U.S. Fish and Wildlife, Scientific Report--Fisheries No. 428. June, 1962.
3. U.S. Army Corps of Engineers, North Pacific Division, "Progress report on fisheries-engineering research program." pp. 154-161, contributed by Washington Department of Fisheries, "Determination of the vertical and horizontal distribution of seaward migrants, Baker Dam." Portland, Oregon. November, 1956.
4. Kupka, K.H., "A false weir fishtrap." The Canadian Fish Culturist, No. 32:53-57. May, 1964.
5. Washington State Department of Fisheries, "Summary report on the experimental testing of fishing gear for determining the vertical and horizontal distribution of seaward migrants in the forebays of dams." Unpublished report submitted to U.S. Army Corps of Engineers, Contract No. DA 35026-eng-20571. September, 1954 to September, 1955.
6. Ducharme, L.J. Andre, "An improved dip net for use in electro-fishing." The Canadian Fish Culturist, No. 40:73-76. February, 1969.
7. Lister, D. Brent, Richard A.L. Harvey, and C.E. Walker, "A modified wolf trap for downstream migrant young fish enumeration." The Canadian Fish Culturist, No. 40:57-60. February, 1969.
8. Walker, C.E., J. Alex Wood, and Iain A. Maclean, "A converging throat trap for sampling juvenile salmonoids." The Canadian Fish Culturist, No. 40:51-56. February, 1969.
9. Hamilton, J.A.R., and F.J. Andrew, "An investigation of the effect of Baker Dam on downstream-migrant salmon." International Pacific Salmon Fisheries Commission, Bulletin VI. New Westminster, B.C. 1954.
10. Schoeneman, Dale E., and Charles O. Junge, Jr., "Investigations of mortalities to downstream migrant salmon at two dams on the Elwha River." Washington State Department of Fisheries, Research Bulletin 3. April, 1954.
11. Allen, Richard, "Lake Merwin juvenile fish collection study." U.S. Bureau of Commercial Fisheries. Fish Passage Research Program. Review of progress, 1964. Seattle. September, 1964.
12. Bentley, Wallace W., and Howard L. Raymond, "Collection of juvenile salmonids from turbine intake gatewells of major dams in the Columbia River system." Transactions of the American Fisheries Society, 97(2):124-126. April, 1968.
13. Erho, Mike, "The vertical distribution of coho smolts in the forebay of Merwin Dam in 1964." U.S. Bureau of Commercial Fisheries. Fish Passage Research Program. Review of progress, 1964. Seattle. September, 1964.
14. Johnson, F. Allen, "A device for fish recovery during turbine-passage mortality studies." The Progressive Fish-Culturist, 32(4):236-239. October, 1970.
15. Pugh, John R., and Jim R. Smith, "Horizontal and vertical distribution of yearlings salmonids in the upper end of Mayfield Reservoir." U.S. Bureau of Commercial Fisheries, Fish Passage Research Program. Review of Progress, 1964. Seattle, Washington. September, 1970.
16. Swan, G.A., R.F. Krcma, and W.E. Farr, "Dipbasket for collecting juvenile salmon and trout in gatewells at hydroelectric dams." The Progressive Fish-Culturist, 41 (12): 48-49. 1979.

Chapter 30

Transportation- Mechanical Hauling of Fish

Necessary amount of space
and water.

Recommended temperature.

Tank types and fish handling.

Aeration methods.

Control of toxic metabolic products.

Aerial planting of trout.

Pumps and air compressors
for aeration.

Barging in fish transportation.

A. 1,000 Gal. Fish Liberation Truck
Loading Table.

B. O₂ Drop After Loading -
Random Loads.

C. Harris-Ramsey Aerator.

D. A Method For Determining
Pounds of Fish in Tanks.

References Reviewed.

TRANSPORTATION - Mechanical Hauling of Fish

Both adult and young fish that are transported by tank trucks must be supplied with oxygen. The tanks generally can accommodate 1 pound of fish per gallon of water. For short hauls, this weight allowance may be increased by as much as 30 percent.

When large fish (30-40 lbs) are hauled, the poundage should be reduced by 50 percent.

When hauling salmon, if the water temperature is above 60 F, the volume of fish must be reduced by approximately 10 percent for each degree of increased temperature. Other species have different temperature requirements, but as temperature affects metabolic rates, the poundage should generally be decreased at temperatures above 50 F.

The capacity of a tank truck is reduced at high altitudes.

Exhibit A shows a loading table used by the Oregon Game Commission, indicating the effect of the more active metabolic rates of the young fish and their distribution within a tank.

The current practice in hauling young is to starve them for two or three days to reduce the oxygen demand. (As adult salmon and trout migrating upstream do not feed, oxygen demand for food consumption need not be considered.) It is commonly known that as fish activity rises the oxygen demand may increase more than threefold. This accounts for the immediate oxygen sag that occurs in tank trucks. As the available oxygen drops to 5 ppm or less, the activity level of the fish drops and the oxygen level in the tank truck may rebuild. Exhibit B shows results of studies on tank trucks made by the Oregon Game Commission.

As fish activity is reduced in cooler water, present-day practice is to reduce tank temperatures to the mid 40's. There is a difference of opinion as to the use of anesthetics in reducing fish activity for the purpose of increasing load. (See Chapter 22, "Anesthetics," for those in use.)

Tank trucks used for hauling young fish may be open or closed, whereas those for hauling adults must be closed systems. Adults usually are placed in the tank trucks from hoppers that fit into a hatch opening. Prior to the introduction of adults into a tank truck, it is filled with water; the hopper load of water and fish is then lowered into the tank by valving the hopper volume. The fish usually are discharged through quick-acting valves or gates. Such trucks also may be used for handling small fish and therefore are equipped for hose connections to permit the discharge of the small fish.

As the amounts of dissolved carbon dioxide and ammonia builds up in the water supply because of metabolic processes, vents must be provided in closed tanks. Aeration of water is provided by venturi action. One such arrangement is shown on Exhibit C. The numbers or pounds of small fish introduced into the tank may be arrived at by a displacement measurement. One such method is shown on Exhibit D. Studies of postplanting mortalities of yearling rainbow trout from four Oregon Game Commission hatcheries compared the effectiveness of the venturi and overhead spray types of aeration equipment. The venturi aeration was judged superior.

Present-day trucks are equipped with mechanical refrigeration. Most tanks are insulated and the exteriors coated with aluminum paint to reduce heat buildup. A tank

truck of modern design is shown on Exhibit E.

Closed tanks are kept full to prevent the sloshing of the water. Open tanks are equipped with baffles to prevent the spillage of water by sudden directional changes.

All areas in contact with the water must be free of toxic compounds. See Chapter 13, "Toxicities of Elements and Compounds."

The pumping capacity usually permits complete recirculation of water in the tanks every five to seven minutes. If ice is used directly as a chiller, it should be free of any chlorine residue.

Shad may be hauled in tank trucks, but special care must be taken in the design of the tanks to eliminate all corners.

The cost of purchasing tank trucks, properly equipped, is subject to inflation, as is their operating cost per mile. These must be checked locally. The cost of distribution varies locally and should be checked.

Capacities vary between 1,000 and 2,000 gallons.

Pure oxygen may be carried as an emergency feature.

Water tempering commonly was practiced at the place of liberation to gradually bring the temperature to that of the receiving water, although some experiments have shown that the value of tempering for differences of less than 10 degrees F. has been exaggerated.

Aeration will remove carbon dioxide to some extent; however, other toxic metabolic products, as ammonia, urea and uric acid, are almost impossible to remove by aeration. As the ammonia concentration increases to 1 ppm, the oxygen concentration in the blood decreases to about one-seventh normal, and the carbon dioxide content increases about 15 percent with resulting suffocation. Therefore, in fish distribution units, it is most practical to prevent, if possible, the production of toxic metabolic products rather than attempting to remove them. On long hauls, complete changes of water load may be necessary.

The buildup of carbon dioxide is often considered another limiting factor in fish transportation. When carbon dioxide remains below 15 ppm, with satisfactory dissolved oxygen and suitable water temperature, it has little effect. When the carbon dioxide level reaches 25 ppm, the fish often show signs of distress. The extent of pH drop in a fish holding unit gives a good indication of the increase in carbon dioxide.

In a few locations, where the terrain makes it advantageous, aerial planting of trout and salmon is accomplished by use of a small water-filled tank. Electrically driven pumps often are used for water circulation, since safety precludes the use of small internal combustion engine-driven pumps in a closed aircraft. Oxygen usually is introduced into the fish tank under pressure regulators and diffused through carborundum stones or carbon rods. The Montana Department of Fish and Game has used a removable 94-gallon capacity cylindrical tank installed in the floor camera port in a small Cessna airplane. A normal load for a short flying time is 200 pounds of trout in 55 gallons of water at temperatures of 40 to 50 degrees F. An electric air pump is used at intervals together with oxygen metered through four carbon rods. The tank is emptied in about three seconds through a 10-inch dump valve at altitudes

TRANSPORTATION - Mechanical Hauling of Fish

of 200 to 300 feet and airspeeds of about 80 miles per hour. If air is introduced to replace the oxygen used, there will be a build-up of nitrogen until the water is saturated or supersaturated. In aerial transportation, where altitude results in a drop in pressure (about 0.5 lb per 1,000 feet), consideration should be given to maintaining altitudes that would not cause bubble disease. No venturi action should be permitted in the delivery system. Aerial distribution is much faster, and is accomplished without significant mortality. Similar aerial distribution procedures are used by other fishery agencies where expeditious.

Loading of the tanks may be accomplished directly from the pond by means of special type pumps which do not injure fish. See Chapter 23, "Fish Pumps."

Smaller, portable 150 to 200 gallon capacity tanks are adapted for use on pickup-type trucks. These tanks usually are equipped with venturi air intakes and overhead spray water circulation, driven by one or two small gasoline engine powered pumps. Regulated oxygen injection also often is used, particularly with small fingerlings. A pressure filter may be inserted in the water circulation system. Such filters are effective in removing solid waste materials, fish scales, and other particulate matter which may clog spray nozzles. The California Department of Fish and Game has

developed an improved design for a small (150-gallon) tank. This is reported to safely carry 500 pounds of catchable-size trout on short hauls by the rapid circulation of water without excessive turbulence. A 1.5-inch centrifugal pump completely circulates the water every 1.5 minutes. Water is drawn from four evenly spaced points on the bottom of the tank, circulated through an aspirator, and discharged through horizontal spray nozzles at four pounds pressure.

An economical method of tank aeration used by the Washington Department of Game is by use of an air compressor operated by a one-half horsepower direct current motor. Air is forced through a number of flat carborundum stones arranged longitudinally and flush with the bottom of the tank. Water circulation is provided by two gas engine-driven pumps having a capacity of 200 to 250 gpm and utilizing an overhead spray system.

Another method of fish transportation, which has been used mainly for anadromous fish and particularly downstream salmon migrants, is barging. Fish are placed in live wells in a barge constructed for continuous flow of water. Specialized barges have been developed by the Corps of Engineers.

A
1,000 Gallon Fish Liberation Truck Loading Table
Maximum Water Temperature, 45 F.

Size in inches	No. per pound	Hauling time hours							
		1/2	1	1-1/2	2	3	4	5	7
Unfed fry*	4,000	180	160	120	100	90	70	60	45
Adv. fry*	2,000	200	190	180	150	135	100	80	80
1-1/2	750	330	300	275	250	200	175	150	100
2	300	500	475	425	370	350	335	275	250
2-1/2	150	650	550	500	475	450	425	400	400
3	90	700	600	550	525	500	475	425	425
4	40	850	750	650	600	550	525	500	475
4-1/2	30	900	800	700	650	600	550	500	460
5	20	1,000	950	800	700	625	575	525	475
5-1/2	15	1,050	975	850	750	650	600	575	500
6	10	1,100	1,025	900	800	750	700	675	600
8	5	1,200	1,100	1,000	875	850	825	800	750
12	1	1,300	1,150	1,000	950	900	850	800	775

*Fry loads over 1-1/2 hour hauls may be increased by 30 per cent if 20 fry baskets are used.

Hauling time is from the time loading of fish is started until completely unloaded.

In hauling eastern brook or salmon, reduce load of fry by 20 per cent, 1-1/2 to 3" fish by 15 per cent, and 3" fish and over by 10 per cent.

From Oregon State Game Commission table.

TRANSPORTATION - Mechanical Hauling of Fish

B
O₂ Drop After Loading - Random Loads
Oregon State Game Commission

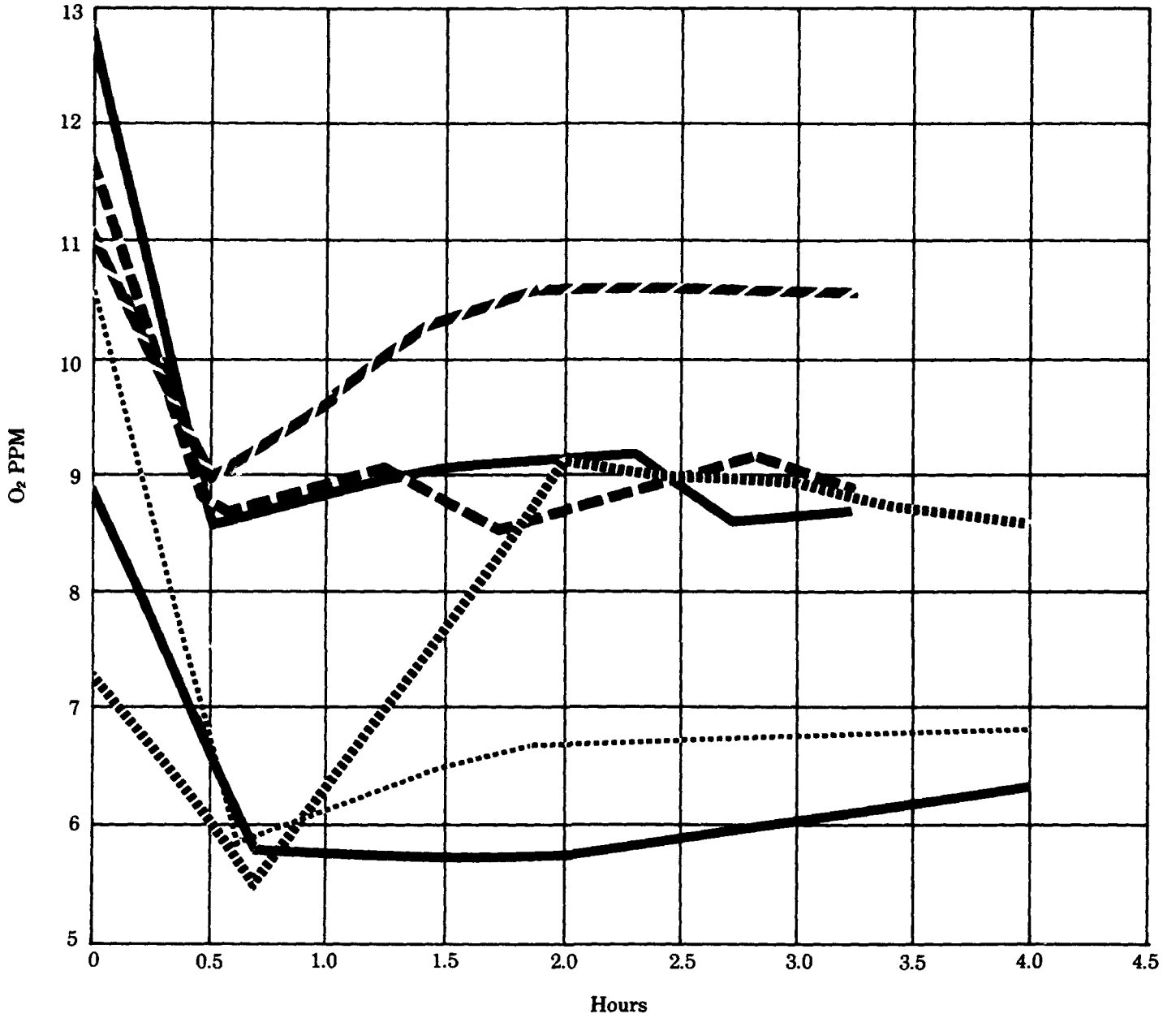

TRANSPORTATION - Mechanical Hauling of Fish

C
Harris-Ramsey Aerator
 Oregon State Game Commission
 9-23-64 KSL

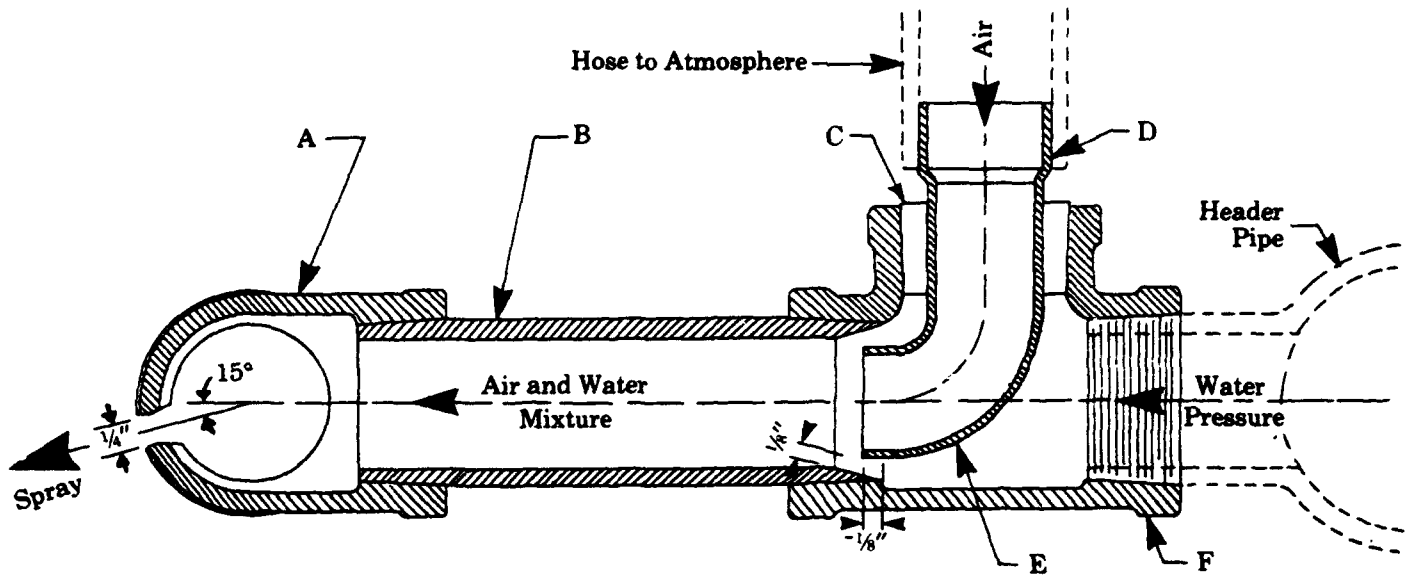

Part	Description	1" Size	3/4" Size
A	Std. B.I.P. Tee, with 1/4" slot run ends open	1" x 1" x 1"	3/4" x 3/4" x 3/4"
B	Std. B.I.P. Nipple	1" x 4 1/2"	3/4" x 4 1/2"
C	Sweat Bushing	1" x 7/8"	3/4" x 5/8"
D	Sweat Reducer	1" x 7/8"	3/4" x 5/8"
E	90° Short radius Sweat Ell	7/8" φ	5/8" φ
F	Std. B.I.P. Tee	1" x 1" x 1"	3/4" x 3/4" x 3/4"

TRANSPORTATION - Mechanical Hauling of Fish

D

FIRST: Fill tank to 2-3 inches over top of gauge orifice, start pump, open valve to gauge. Magnets attach gauge to side of tank.

Figure 1.
Initial Setting

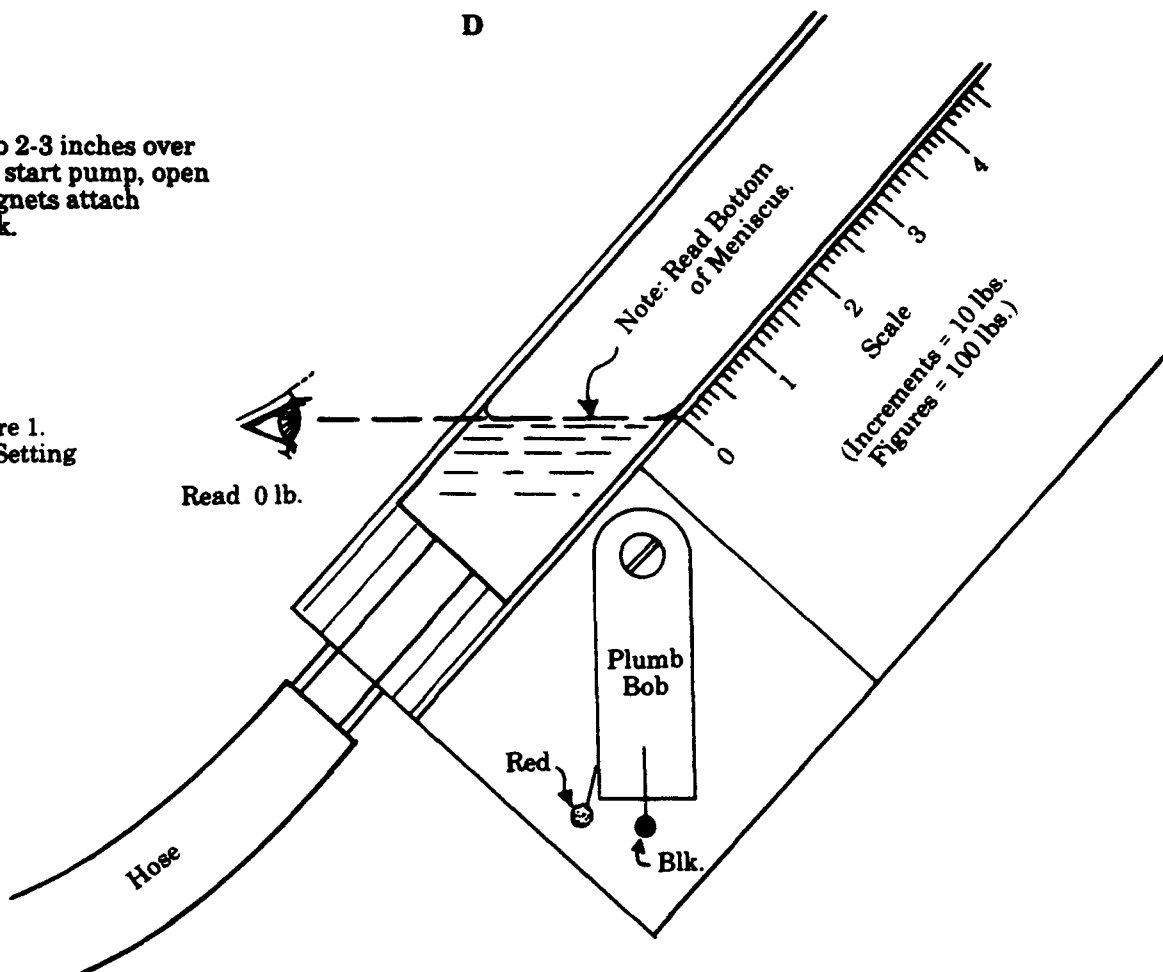

SECOND: Simultaneously set scale to read 0 lb. (Fig. 1) on the bottom of the meniscus and plumb-bob to required dot on gauge body. The black dot for 4 holer (9'-6" 1.0.) and red dot for 3 holer (8'-0" 1.0.) tank.

Figure 2.
Reading Scale

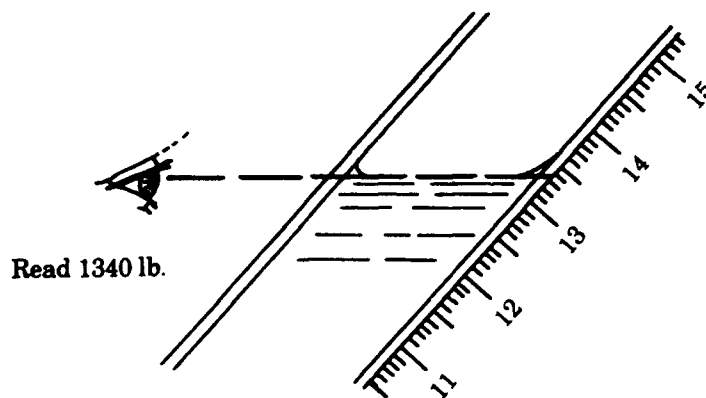

THIRD: Read lbs. (dry) fish loaded directly off scale as shown in Fig. 2. With practice, the scale may be interpolated to 5 lb. readings. It is assumed that fish have the same density as water. This gives an error of less than 1 percent.

Oregon State Game Commission

TRANSPORTATION - Mechanical Hauling of Fish

References Reviewed

1. Horton, Howard F., "An evaluation of some physical and mechanical factors important in reducing delayed mortality of hatchery-reared rainbow trout." *The Progressive Fish-Culturist*, 18(1):3-14. January, 1956.
2. Horton, Howard F., "The factors leading to post-liberation mortalities of trout transported in tank trucks." University of Michigan, University microfilms, Ann Arbor. 1964. (Listed in *Dissertation Abstracts*, 24(8). 1964.)
3. Elliott, Joseph W., "The oxygen requirements of chinook salmon." *The Progressive Fish-Culturist*, 3(2):67-73. April, 1969.
4. Davison, Robert C., Wilbur P. Breese, Charles E. Warren, and Peter Doudoroff, "Experiments on the dissolved oxygen requirements of cold-water fishes." *Sewage and Industrial Wastes*, 31(8):950-966.
5. Phillips, Arthur M., and Donald R. Brockway, "Effect of starvation, water temperature, and sodium amytal on the metabolic rate of brook trout." *The Progressive Fish-Culturist*, 16(2):65-68. April, 1954.
6. Haskell, David C., and Richard O. Davies, "Carbon dioxide as a limiting factor in trout transportation." *New York Fish and Game Journal*, 5(2):175-183. July, 1958.
7. Fry, F.E.J., "Aquatic respiration of fish." In "The Physiology of Fishes," edited by Margaret E. Brown, 1:1-63. Academic Press, Inc., New York. 1957.
8. Nemoto, Carl M., "Experiments with methods for air transport of live fish." *The Progressive Fish-Culturist*, 19(4):147-157. October, 1957.
9. Gebhards, Stacy V., "Transport of juvenile trout in sealed containers." *The Progressive Fish-Culturist*, 27(1):31-36. January, 1965.
10. Norris, Kenneth S., Frank Brocato, Frank Calandrino, and William N. McFarland, "A survey of fish transportation methods and equipment." *California Fish and Game*. 46(1):6-33 January, 1960.
11. Macklin, Robert, "An improved 150-gallon fish-planting tank." *The Progressive Fish-Culturist*, 21(2):81-85. April, 1959.
12. Ellis, C.H., and R.E. Noble, "Barging and hauling experiments with fall chinook salmon on the Klickitat River to test effects of survivals." Washington State Department of Fisheries, Annual Report, 70:57-71. 1960.
13. Cooper, R.O., "Aerial fish distribution in a Montana lake." *The Progressive Fish-Culturist*, 19(4):190-192. October, 1957.
14. Pearson, Lincoln S., Kelly R. Conover, and James B. Haas, "An evaluation of adult coho salmon transplants into Willamette River tributaries." Oregon Fish Commission, Research Briefs, 13(1):25-38. Portland. June, 1967.
15. Beal, Fred R., "A fish-planting barge." *The Progressive Fish-Culturist*, 24(1):21. January, 1962.
16. Carey and Kramer, and Johnson and Anderson, Consulting Engineers, "A comprehensive plan for the anadromous fish hatchery program for the State of Michigan - Volume 1. General considerations and site selections." Prepared for Michigan State Department of Conservation, Lansing. January, 1968.
17. Henegar, Dale L., and Donald C. Duerre, "Modified California fish distribution units for North Dakota." *Progressive Fish-Culturist*, 26(4):188-190. October, 1964.
18. Leitritz, Earl, "Trout and salmon culture (hatchery methods)." California Department of Fish and Game, Fish Bulletin No. 107.
19. Berst, A.H., and J.W. Anderson, "Aerator for fish hatchery transport." *The Canadian Fish Culturist*, 15:18-25. April, 1954.
20. Eicher Associates, Inc., and VIN Oregon, "Smolt transportation feasibility on the mid-Columbia River." Prepared for Chelan, Douglas and Grant Public Utility Districts. April 1981.
21. Basham, Larry R., and others, "Fish transportation oversight team annual report - FY 1982. Transport Operations on the Snake and Columbia Rivers." NOAA Technical Memorandum NMFS/F/NWR - 5. February 1983.
22. S.K. Johnson, "Transport of Live Fish." Fish Disease Diagnostic Laboratory, Texas Agricultural Extension Service, Department of Wildlife and Fisheries Sciences, The Texas A & M University System, College Station, Texas. March 1979.

Chapter 31

Culverts

Normal culvert design is not compatible with fish passage.

Energy dissipating baffles may be installed in existing culverts.

Small fish require a low gradient.

Superimposition of head may be permissible for average floods.

Outlet structures may be required at installed culverts.

Length of culvert is a factor in design.

Table 1. Culvert Velocity at 1/6 D That Permits Fish of Various Swimming Abilities to Transverse Culverts of Various Lengths.

References Reviewed.

CULVERTS

Culverts designed and built for water passage only are not generally compatible with requirements for fish passage. They may be installed at a slope to pass maximum flows with a minimum diameter, resulting in high velocities that would prevent the upstream passage of fish. Existing culverts, if they were designed primarily for water passage, generally require alterations if fish are to pass through them.

Reference No. 4 gives details of a type of baffle that will permit passage of fish in large culverts. Culverts with diameters 3 feet and less should not be used where adult fish passage is required, as the core velocity would be too high. To permit fish to swim through a culvert, a flow depth at least equal to the body depth of the maximum sized fish should be provided. (See Chapter 6, "Swimming Speeds of Adult and Juvenile Fish.")

If small, feeding fish moving upstream are to be passed, bottomless arch culverts, or large culverts with a pavement of gravel, would be best suited. Slopes should be held to 0.005 as an upper limit, or they may match the natural stream bed slopes up to this level.

Culverts should be designed to pass at least the average flood flows, with the superimposition of head at the upstream end to increase the velocity to the equivalent slope of .005. If the entrance of a culvert is not flaired, a coefficient of contraction of 0.9 should be applied in determining the entrance velocities.

The slope of the culvert can be determined by the method suggested in Chapter 8, "Food Producing Areas."

The average velocity generated at a set slope may be determined by applying the same formula and appropriate roughness as shown in Chapter 8.

A problem with existing culverts can be the drop that has been created by erosion at the outlet, which prevents small fish from passage and which can discourage larger fish from attempting passage. To correct these deficiencies requires the construction of an outlet structure in the form of a fishway, the raising of the stream by a series of downstream rock barriers, or the replacement of the culvert.

In determining culvert size, the length of the culvert at various slopes is a major factor in the ability of fish to swim through it at a site-generated velocity. Table 1 gives an approximation of culvert lengths, compatible with fish passage and varying culvert velocities. (See also Exhibits A, B and C, Chapter 6, "Swimming Speeds of Adult and Juvenile Fish.")

To prevent scour, the water level in the culvert pipe at maximum flow should approximate the stream level below the culvert. This will require that the culvert be set below bed level at one-half its diameter, which would allow gravel to collect in the pipe at flows less than flood level. As this could create problems in construction and operation, either an elliptical-shaped culvert or an arch culvert would be recommended.

CULVERTS

References Reviewed

1. Russell, George E., "Hydraulics." Fifth edition. Henry Holt and Company, New York. 1952.
2. American Concrete Pipe Association, "Concrete pipe handbook." The Association, Chicago, Illinois. 1958.
3. King, Horace Williams, "Handbook of hydraulics." Fourth edition. McGraw-Hill Book Company, Inc., New York. 1954.
4. McKinley, W.R., and R.D. Webb, "A proposed correction of migratory fish problems at box culverts." Washington Department of Fisheries, Fisheries Research Papers, 1(4):33-45. March, 1956.
5. Armco Drainage and Metal Products, Inc., "Handbook of drainage and construction products." Armco Drainage and Metal Products, Inc., Middletown, Ohio. 1955.
6. Evans, Willis A., and Beryl Johnston, "Fish migration and fish passage." U.S. Department of Agriculture, Forest Service. Washington, D.C. June, 1972, revised June, 1980.
7. MacPhee, Craig, and Fred J. Watts, "Swimming performance of Arctic grayling in highway culverts." Progress Report to U.S. Fish and Wildlife Service under Contract No. 14-16-0001-5207. University of Idaho, Moscow. January, 1975.
8. Morsell, J.W., J. Hemming, J. Houghton, and M. Bell, "Fish protection strategies for the design and construction of the Alaska segment of the Alaska natural gas transportation system." Preliminary draft prepared by Dames & Moore for Northwest Alaskan Pipeline Company under Contract No. 478086-9-K 139. Anchorage, Alaska. January, 1981.
9. Watts, F.J., "Design of culvert fishways." Water Resources Research Institute, University of Idaho, Moscow, Idaho. May, 1974.
10. Parish, R.P., P. Eng., "Fish vs culvert design." Paper presented at Alberta Hydrotechnical Seminar. Bolter Parish Trimmer Ltd., Edmonton, Alberta. February, 1976.
11. Hendrickson, John G., Jr, "Hydraulics of Culverts." American Concrete Pipe Association, Chicago, Illinois. 1957.

Chapter 32

Channel Changes

Three major purposes for channel changes.

Principal methods used.

Natural floods may cause new channels.

Effect of increased velocities.

Manning's and Chezy's formulae for determining velocity.

Application of formulae to Washington streams.

Wetted perimeter effect on velocity.

Pools and riffles affect velocities in chute sections.

Importance of gravel size.

Methods of dissipating in a reach.

Importance of bed stability.

1. Gravel Sizes and Limiting Tractive Forces Required for a Stable River Channel Bed.

2. Gravel Sizes Based on Average Column Velocity and Bottom Velocity.

A. Altered Stream Bed.

B. The Negative Effects of Log Jams on the Propagation of Migratory Fish.

References Reviewed.

CHANNEL CHANGES

There are three major purposes in making channel changes in a stream: one, to increase the water discharge capacity of a localized stream channel; two, to shift the location of the bed for purposes of construction in the original bed, which results in rechannelization; and, three, to construct dams, which have a major influence on channel changes. (See Exhibit A.) The pool created upstream from a dam, except at the upstream end of the pool, may drown out suitable spawning and food-producing areas. These changes can be evaluated only by a review of the project operational programs and the projected backwater levels.

The two principal methods used in making channel changes are the elimination of bends to increase gradient and the deepening of a stream section to reduce frictional components. In many cases, because of the increased velocities created by these methods, bank revetment is required to prevent bends from reforming.

Natural flood flow levels may cause new channels to form in a flood plain and may cause severe localized scour on banks and beds. Changes occur particularly in braided stream areas where debris and jams or fallen trees may cause erosion. (See Exhibit B.) Except for the formation of new channels, the changes are generally localized. It may be assumed that natural changes occur at discharges which are greater than bank-full flows. This is shown in Reference No. 3. Flight pictures may be used to evaluate such changes by comparing aerial surveys made over a period of years.

Only flows less than bank full are suitable for salmonoid production. Ephemeral wetting of bed areas is not productive of food organisms or spawning conditions, which are primary concerns. See Chapter 7, "Spawning Criteria." The first year's loss in a stream by a completely disturbed channel may be 80 pounds of salmonoid migrants per acre of stream bed.

A value for the average sectional velocity can be determined by utilizing either:

Manning's formula

$$V = \frac{1.486}{N} R^{.67} S^{.5}$$

$$V = \frac{1.486}{N} R^{.67} S^{.5}$$

where N = channel roughness, assumed to be .025-.035

R = hydraulic radius, $\frac{\text{wetted area}}{\text{wetted bed surface}}$

S = slope

or Chezy's formula

$$V = C\sqrt{RS}$$

$$\text{where } C = \frac{1.486}{N} R^{1/6}$$

The above gives C as 42-59 for the above channel roughness.

Tables for the values in the equations, with varying N and R values, are contained in the publication, "Hydraulic

Tables," prepared under the direction of the Chief of Engineers, U.S. Army, United States Government Printing Office, Washington, D.C. 1944. See Chapter 7, "Spawning Criteria," for additional details.

Data from a number of cross sections taken in State of Washington streams show that the roughness coefficient average of a section is .025 to .035, giving a Chezy value of 42-59 in the stream bed areas most productive for spawning and food generation. At low flows the wetted perimeter (P) approaches the width of the stream. As stream bed pavement where spawning and food production occur consists of various grades of rock (up to 6 inches in diameter), an assumption can be made that the wetted perimeter is 1.03 times the stream width at productive levels.

A natural fish-productive stream bed generally consists of a series of pools and riffles. A reach of river one mile long containing both pools and riffles can have three times the average velocities in the chute sections (above the average river slope velocities), depending on the number of pools in the reach (from two to ten per mile). In the latter case, the chute section could contain velocities in excess of those accepted for salmonoid spawning. Under these conditions, it would be expected that spawning would be limited primarily to the upper parts of the chutes leading out of the pools. The effect of pools is to stabilize a reach as the full velocity head is lost in a pool area at flows less than bankfull. In reach-controlled sections, the energy is dissipated reasonably uniformly throughout the length of the reach.

At bankfull flows and above the bed roughness has minimal effect and at high flows the pools may be completely drowned out, requiring reach control.

Under natural conditions bank and bed pavements are of the size that resist movement. (See Tables 1 and 2.)

As R increases, the stream roughness coefficient under bankfull flows and above will change. The average velocity will therefore increase.

As spawning and food production criteria call for velocities up to two feet per second, it is evident that such areas are stable under productive flow levels. If bends are eliminated, the increased slope must be compensated for by heavier bed pavement, commensurate with the new velocities. This will result in the decreased spawning capability of the stream. Larger materials result in increased wetted perimeters and frictional components under less than bankfull flow conditions.

Rock hurdles or dykes may be provided to form chutes and pools, thus dissipating the energy by destroying the velocity head in a pool. This type of configuration normally results in the heavier rock hurdles being displaced and random configurations being formed. The subsequent filling above the hurdles ultimately provides spawning and food-producing areas. Unless carefully engineered, such channel changes may remain unstable, requiring ten or more flood flows to produce a relatively stable channel. Normal deepening and widening usually results in removal of coarser pavement, resulting in less channel head loss at all flows, thus disturbing the spawning and food-producing capabilities of the stream. A suggested method for compensation would be the artificial development of riffles and pools, as normal reach control stability

CHANNEL CHANGES

cannot be satisfied, resulting in digging and filling at flood stages in a random manner. The return of some heavy materials up to 6 inches is recommended in all chute sections.

A braided reach will form in the natural channel below an increased slope section, if it is greater than the slope of the natural bed downstream from the change. If heavy rock bank revetment is used, the stream width at flood flows will be constricted, resulting in bed scour.

Table 1

Gravel Sizes and Limiting Tractive Force Required for a Stable River Channel Bed

Gravel Size and Weight			Limiting Tractive Force*
(inch)	(ft)	(lb)	
0.25	.002	.001	0.1
1.0	.083	.05	0.4
1.5	.125	.2	0.6
2.0	.166	.35	0.8
2.5	.21	.7	1.0
3.0	.25	1.0	1.2
4.4	.37	3.0	1.76

* Tractive force = lb/ft^2 .

Unit weight of water x depth of flow x diameter in inches.

Tractive force = $0.4 \times$ diameter in inches, approximately.

Table 2

Gravel Sizes Based on Average Column Velocity and Bottom Velocity

Gravel Size and Weight			Average Column Velocity	Bottom Velocity*
(inch)	(ft)	(lb)		
0.25	.002	.001	2.5	1.5
1.0	.083	.05	5.0	3.0
1.5	.125	.2	5.5	3.3
2.0	.166	.35	6.5	3.9
2.5	.21	.7	8.0	4.8
3.0	.25	1.0	8.5	5.1
4.4	.37	3.0	9.0	5.4

* Bottom velocity = $0.6 \times$ column velocity.

CHANNEL CHANGES

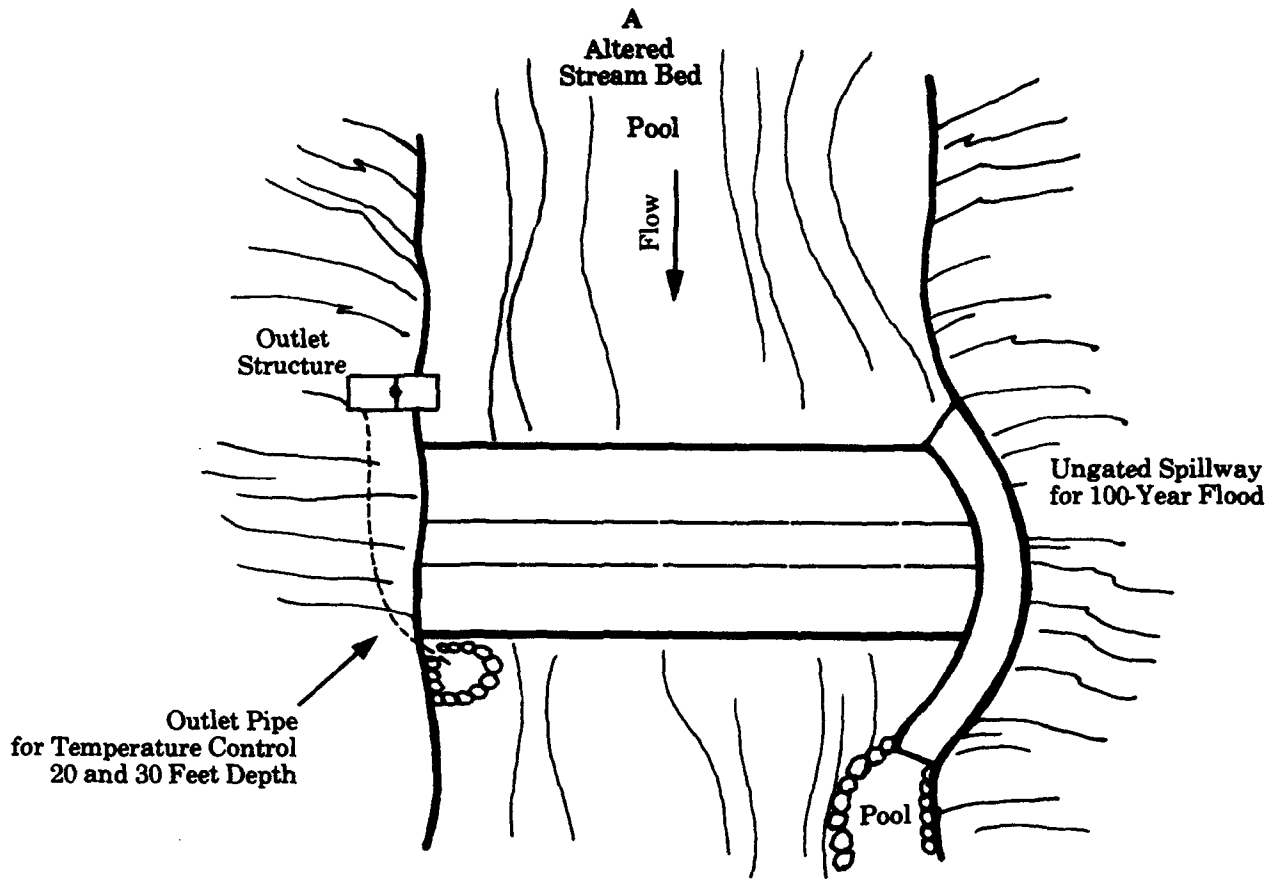

Plan
(No Scale)

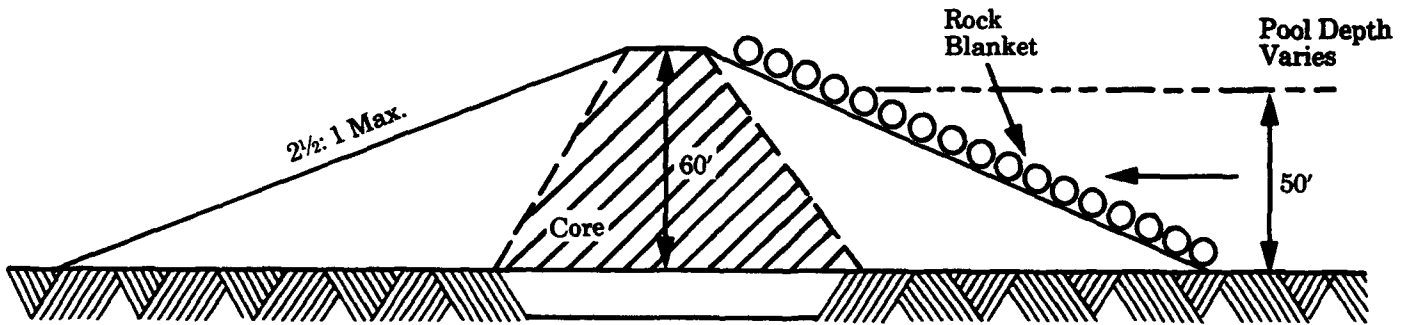

Typical Section
(No Scale)

CHANNEL CHANGES

B

The Negative Effects of Log Jams on the Propagation of Migratory Fish

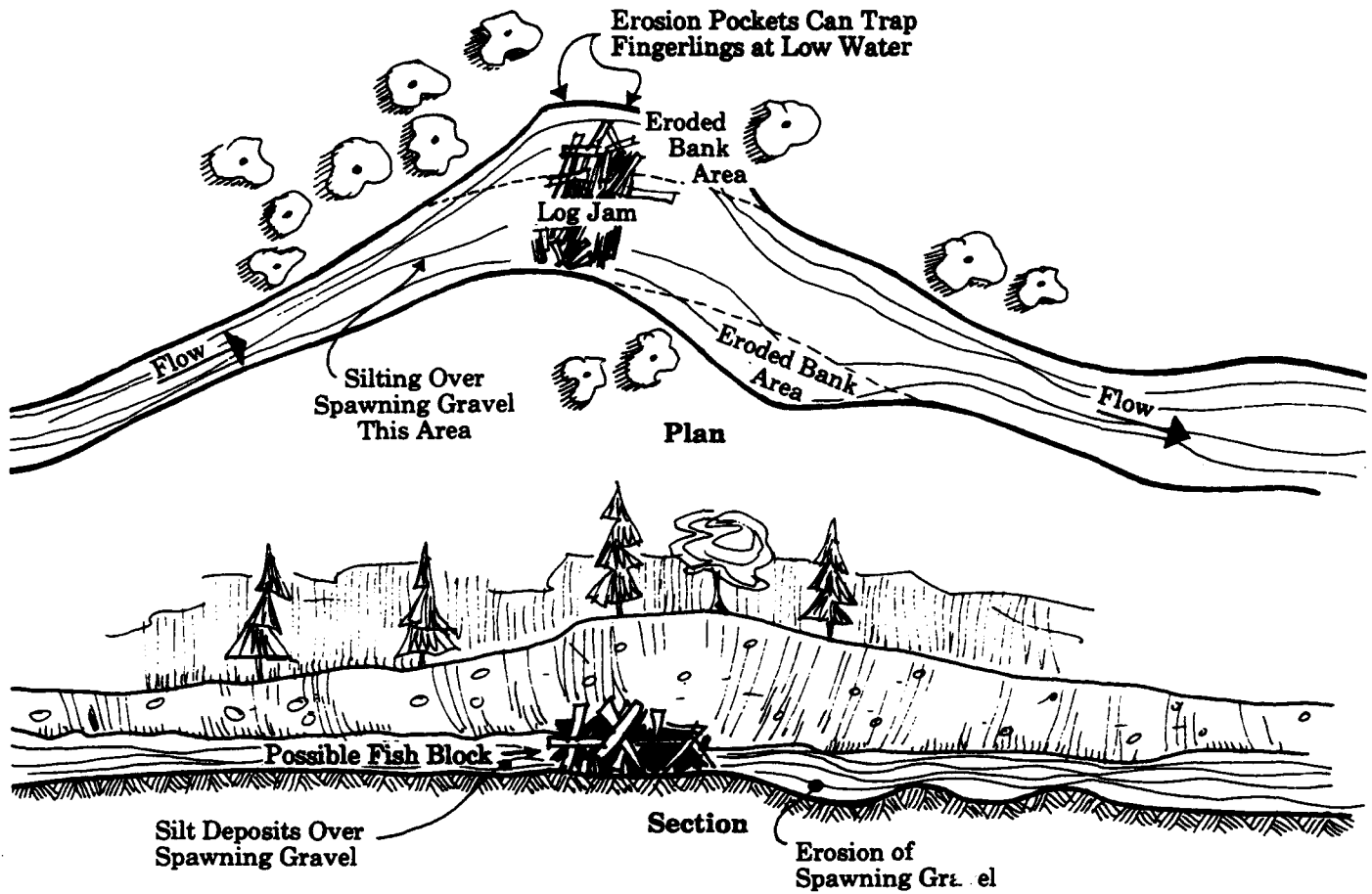

CHANNEL CHANGES

References Reviewed

1. Hayes, F.R., "Artificial freshets and other factors controlling the ascent and population of Atlantic salmon in the LaHave River, Nova Scotia." Fisheries Research Board of Canada, Bulletin No. 99. 1953.
2. Beland, R.D., "The effect of channelization on the fishery of the lower Colorado River." California Fish and Game, 39(1):137-139. January, 1953.
3. Leopold, Luna B., and Thomas Maddock, Jr., "The hydraulic geometry of stream channels and some physiographic implications." U.S. Geological Survey, Professional Paper No. 252. Washington, D.C., 1953. Reprinted, 1959.
4. Canada Department of Fisheries and International Pacific Salmon Fisheries Commission Technical Staffs with British Columbia Department of Recreation and Conservation, Fish and Wildlife Branch, "Effects of log driving on the salmon and trout populations in the Stellako River." International Pacific Salmon Fisheries Commission Progress Report No. 14. Vancouver, B.C. 1966.
5. Rees, William H., "Effects of stream dredging on young silver salmon (*Oncorhynchus kisutch*) and bottom fauna." Washington State Department of Fisheries, Fisheries Research Papers, 2(2):53-65. April, 1959.
6. U.S. Bureau of Reclamation, Engineering Laboratories, "Progress report on results of studies on design of stable channels." Hydraulic Laboratory Report No. Hyd-352. Denver, Colorado. June, 1952.
7. Stuart, T.A., "The influence of drainage works, levees, dykes, dredging, etc., on the aquatic environment and stocks." International Union for the Conservation of Nature and Natural Resources, Proceedings and papers of the seventh technical meeting, Volume 4:337-345. Athens, Greece. 1958.
8. U.S. Department of Interior, Bureau of Reclamation, "Design of Small Dams." Second Edition. Washington, D.C. 1973.

Chapter 33

Locks and Mechanical Handling

Surface and pressure locks.

Rounds vs. rectangular locks.

Removal of fish from lock chamber.

Types of approach to improve attraction and discharge.

Success in use of locks vs. use of hauling tanks.

Factors in design of a lock.

A. Fish Lock.

B. Lift.

References Reviewed.

LOCKS and MECHANICAL HANDLING

There are two general types of fish locks: the surface type (open to the atmosphere as a ship lock); and the pressure type, which has a closed connection between the river and the upper pool. Both require the attraction of fish into the lock by the addition of water to the lock chamber, the holding of fish throughout the cycle, and a current pattern that attracts the fish away the lock.

The operation of an open fish lock is similar to that of a navigation lock. Beginning with the fishing period, a part of the attraction water is discharged from the lock chamber. At the cessation of the fishing cycle, a part or all of the fish in the holding area are moved into the chamber and the lower lock entrance is closed. Filling begins with the transfer of the attraction water to the entrance bay, so that there is only minor variation in the attraction outflow. As the filling of the lock is completed, the upper gate opens and the water is brought into the lock by cracking the discharge valve. Once the fish have left the lock (and a brail may be needed to accomplish this), the upper gate is closed, the lock is drained to operating level, and the cycle is reestablished.

Round locks are preferable to rectangular locks, as fish tend to jump at corners. Fish are normally held within the lock by means of a finger or V trap, both of which require mechanical adjustment because of changing tail water. Maximum velocities over finger traps are 8 feet per second, and minimum of 4 feet per second is recommended through V traps.

Experience has shown that there is some retention of fish in both surface and pressure-type lock chambers, unless the fish are mechanically swept from the chamber. Pressure alone is not always sufficient to lead fish from a pressure lock or to cause them to rise to the surface of an open lock. Without a mechanical sweep, the locking cycle time is materially increased. For the purpose of rapid attraction into the lock, the fish, as they approach the lock chamber, must be held at or near the entrance.

Figure A shows an idealized lock system that uses an entrance bay with a V-trap entrance to hold the fish, and a movable sweep, or crowder, to move them into the lock chamber. This is a gravity (or open) lock and it can be automated, although such automation has not been proved to be trouble-free. This system offers a great advantage in that it can move small fish or fish with weak motivation or weak swimming characteristics.

The most effective method of introducing attraction water to a lock is through a bottom diffusing area, reducing the jumping of fish to a minimum.

Unless a crowder is provided, locks appear to be more successful when used with a short fishway system that allows the fish to become accustomed to the new environment and they appear to enter a lock more readily with this provision. Such a fishway should operate at least between minimum and normal tailwater levels. A fishway complicates the mechanical balance of water surfaces but lessens the disadvantages to the fish by a delayed entrance.

Some species refuse to surface or jump and must be accommodated by underwater ports. Conversely, certain species prefer surface passage.

The use of light for attracting fish from locks has been investigated but has not been proved to be of great aid in decreasing passage time.

Locks, as now installed, have between 300 and 400 square feet of surface area. This is a space room provision. In principle, locks can be operated successfully but, in actual operation, they have not been shown to have any advantages over conventional fish passage systems for many species.

Fish may be lifted in a bucket and transported by mechanical means to a position in the forebay above a dam or discharged into a hauling tank for delivery at any distance above the operation. The design of buckets should follow the design of holding tanks as to supplies of oxygen and space room. It has been found that fish respond to a bucket's vertical movement by ceasing their general movement but that, if they are kept in captivity, they will again begin jumping. To discourage this, covers over tanks are provided.

Fish may be delivered by chutes at the unloading position, but the preferred method of discharge from the lifting bucket to a hauling tank is by the principle of lowering and locking, thus delivering the fish from a full bucket into a full tank and valving out the water volume of the delivery tank and, thereby, lowering the fish into the hauling tank without shocking them. By lowering it into the forebay, the bucket is discharged below the water surface.

In the design of lifts, none has been fully automated and they generally require 7-day operation and 16-hour days, thereby introducing mechanical and human problems. The attraction of possibly reduced capital costs of lifts must be measured against increased operational costs.

Generally, in the design of a lock it should be assumed that 80 percent of the fish will position themselves between depths of 3 and 6 feet and that a minimum of 20 cubic feet should be supplied for each large adult fish (10 pounds plus) held if the holding period is from 30 minutes to 1 hour, and 30 cubic feet if the holding period is 8 hours or more.

Figure B shows an idealized fish lift with a V-trap entrance to hold the fish and a movable sweep, or crowder, to move them into the bucket.

See Chapter 30, "Transportation - Mechanical Hauling of Fish," for details of transportation.

Experience with lifts or locks where fish are not immediately introduced into the bucket or chamber and are subjected to a number of recycling operations has shown that fish may be discouraged and may remain in the collection system or approach area.

LOCKS and MECHANICAL HANDLING

A Fish Lock

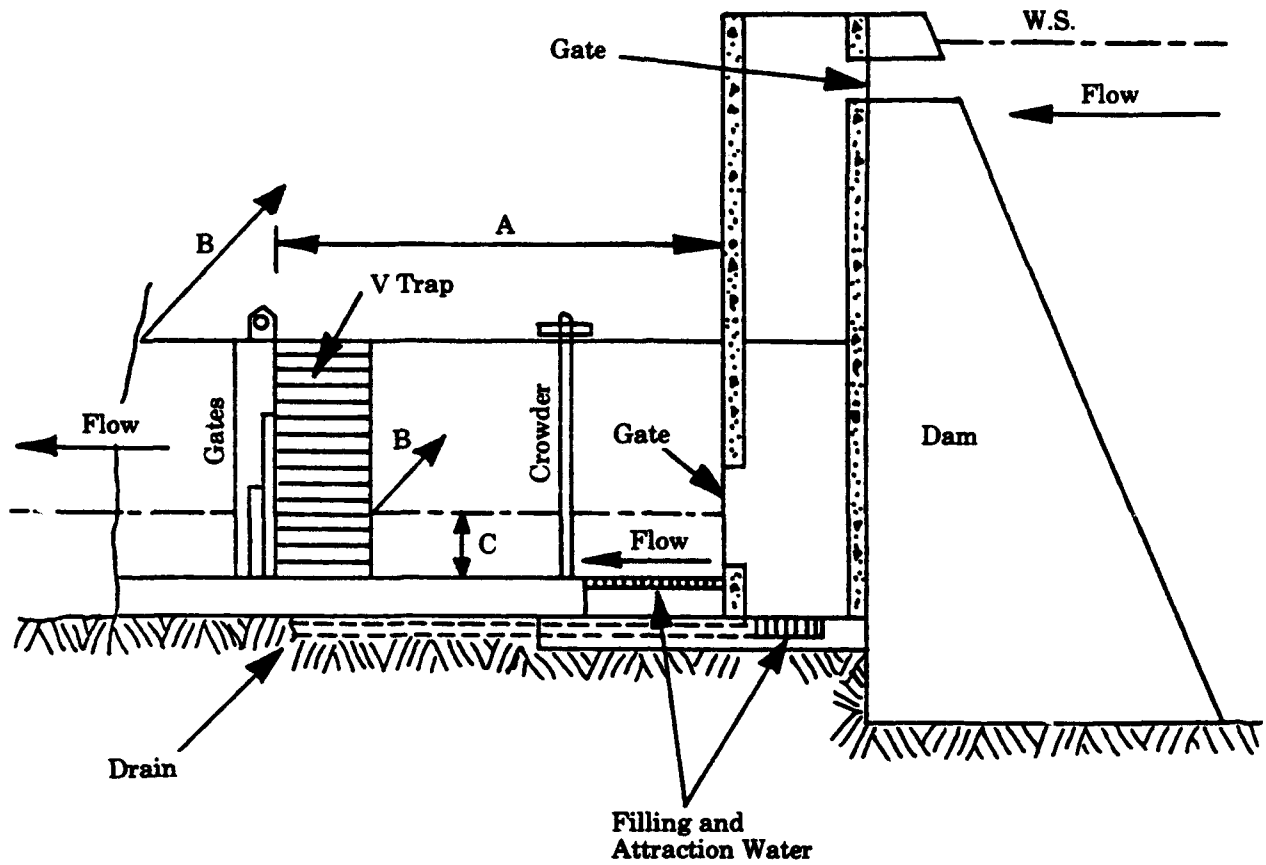

A Pool Length	8'	12'	16'
B Pool Width	4'	6'	8'
C Water Depth (Min)	3'	3'	3'
D Lock Chamber	24□ ¹	36□ ¹	64□ ¹
Discharge Variable (Min)	30	30	30

LOCKS and MECHANICAL HANDLING

B Lift

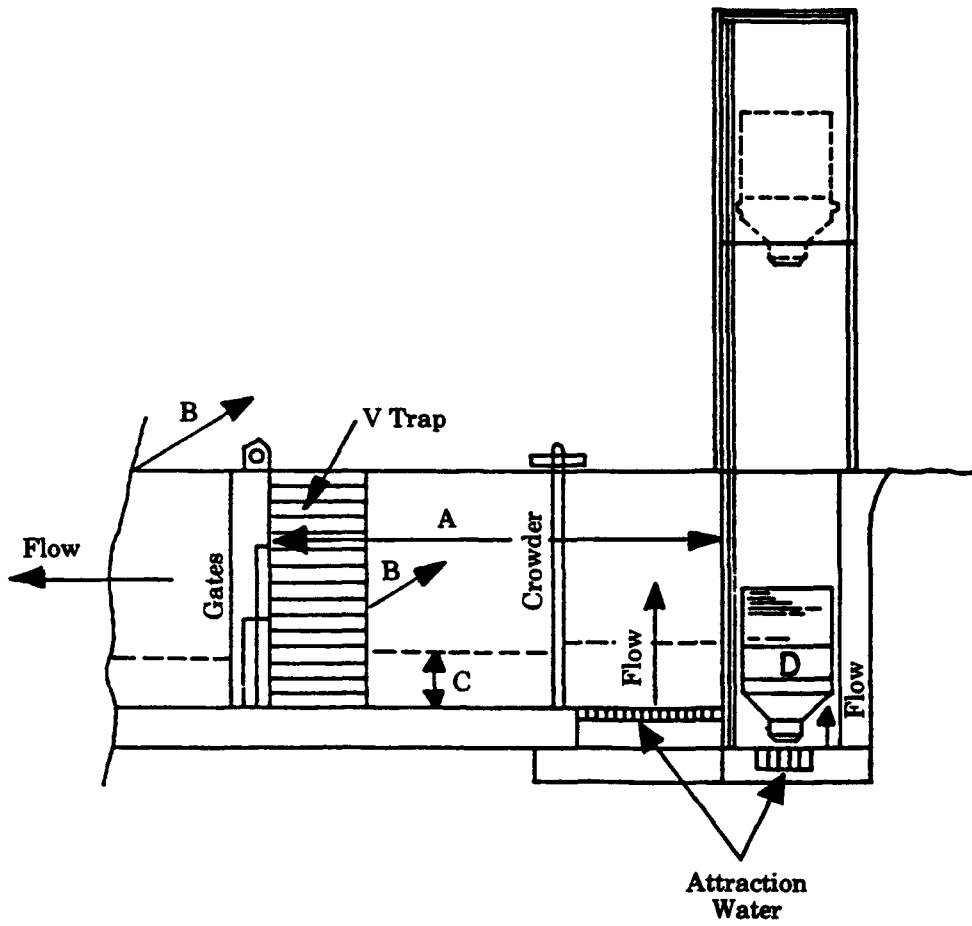

A Pool Length	8'	12'	16'
B Pool Width	4'	6'	8'
C Water Depth (Min)	3'	3'	3'
D Hopper Size (Gal)	250	500	750
Discharge Variable (Min)	30	30	30

LOCKS and MECHANICAL HANDLING

References Reviewed

1. Kipper, Z.M., and I. Mileiko, "Fishways in hydro developments of the U.S.S.R." pp. 24-37, 46-53. Rybnoe Khozyaistvo, Moscow. 1962. Translated by A. Wald, Israel Program for Scientific Translations Ltd. U.S. Department of Commerce, Clearinghouse for Federal Scientific and Technical Information, Springfield, Virginia. 1967.
2. Carter, Bernard T., "The movement of fishes through navigation lock chambers in the Kentucky River." Kentucky Academy of Science, Transactions, 15(5):48-56. October, 1954.
3. Clay, C.H., "Design of fishways and other fish facilities." Canada Department of Fisheries, Ottawa. January, 1961.
4. "First salmon pass Bonneville Dam; fish locks and fish ladders function successfully." Engineering News Record, 120(21):733. May 26, 1938.
5. Beak, T.W., "Scotland's salmon fisheries." Atlantic Salmon Journal, Issue No. 4:12-14. December, 1955.
6. "1954 progress report of experiment with the pressure fishlock at McNary Dam." U.S. Corps of Engineers, Walla Walla District, 4:7. Walla Walla, Washington. 1954.
7. Andrew, F.J., and G.H. Geen, "Sockeye and pink salmon production in relation to proposed dams in the Fraser River system." International Pacific Salmon Fisheries Commission, Bulletin XI. New Westminster, B.C. 1960.
8. Henneasy, H.A., "Construction of a Borland-type fish pass at Ardnacrusha generating station." Transactions of the Institution of Civil Engineers of Ireland, 86(5): 111-127. 1960.
9. Deelder, C.L., "Modern fish passes in the Netherlands." International Union for the Conservation of Nature and Natural Resources, Proceedings and Papers of the 7th Technical Meeting, pp. 317-320. Athens, Greece. 1958.
10. Gordon, R.N., "Fisheries problems associated with hydroelectric development." The Canadian Fish Culturist, No. 35:17-36. October, 1965.
11. Baker, W. Donald, "A 'fish lock' for passing fishes through small impoundment structures." A paper presented at the annual meeting of the Southern Division of the American Fisheries Society, Asheville, North Carolina, October 24-26, 1965. North Carolina Wildlife Resources Commission, Raleigh. 1966.
12. U.S. Army Corps of Engineers, Portland District, "Information bulletin, fish passage facilities, Bonneville Dam, Columbia River, Oregon and Washington." Report 66-1. Compiled for Office of Chief of Engineers by Bonneville Hydraulic Laboratory, Bonneville, Oregon. April, 1958.
13. Murphy, A.M., and J.C.I. Dooge, "The hydraulic fish lift at Leixlip." Transactions of the Institution of Civil Engineers of Ireland, 77(3):61-88. April, 1951.

Chapter 34

Fishway Structures at Dams and Natural Obstructions

Fishway head differences.	Discussion of counting stations.	M. A Downstream Passage Facility Used at a High Dam (Supporting Framework and Hoisting Mechanism Omitted).
Structures size criteria.	Brief mention of fish locks.	N. The Dalles Dam.
Basis of choice for fishway patterns.	Effects on migrants of deep reservoirs in river areas.	O. Dexter Dam.
Limited application for Denil fishway types.	Nitrogen entrainment under certain spillway conditions.	P. McNary Dam - Washington Shore Fish Ladder - Lower Section.
Shad	Criteria for design of temporary fishways during construction of permanent structures.	Q. Bonneville Dam - Fish Passing Facilities.
Eel passes	Low head dams.	R. The Dalles Dam - Fish Water Supply Turbines.
Sturgeon	Fishway Design Data (check list).	S. Fishway Turbine Pump - Chelan County P.U.D. Rocky Reach Project.
Special considerations for site conditions.	A. Typical Layout for Fishway at Power Dams. All Gates Open with Crowned Operation - By Restricted End Gate Openings.	T. The Dalles Dam - Fish Lock.
Trash rack openings.	B. Typical Layout for Fishway at Power Dams. Limited Spill Regulation - Expanded as Flow Increases.	U. McNary Dam - Washington Shore Fish Ladder and Fish Lock.
Fish jumping-causes and prevention.	C. Typical Layout for Fishway at Power Dams. Limited Spill Regulation - Side Gates Open Only.	V. The Dalles Dam - Powerhouse Fish Facility.
Hydraulic instability can occur.	D. Typical Spillway Fishway Entrance.	W. McNary Dam Powerhouse.
Discussion of weir and orifice-type fishways.	E. Streaming or Shooting Flow; Plunging Flow.	X. Slotted Fishway (Wooden Baffles).
Methods of trapping fish.	F. Ice Harbor Weir Crest.	Y. Prosser Dam Fishways.
Times of fish movement.	G. Pool and Weir Fishway.	Z. McNary Dam Fishways Showing Undesirable Surge.
Position of fishway entrances and light effects.	H. Vertical Slot Fishway.	AA. Hell's Gate Fishways, Fraser River.
Effect of spillway flow.	I. Denil Fishway.	BB. Deschutes Fishway No. 3.
Relation of submerged or surface-type jump to fishway entrances.	J. Discharge for Single Slot Fishway.	CC. Salmon Jumping Over Weir.
Collection systems at powerhouses.	K. Finger Trap, Shapes of Weir Crests.	DD. McNary Spillway, Bonneville Hydraulics Laboratory.
Methods of attracting fish to desired locations.	L. Cross Section Through False Weir.	EE. Fish Ladder, Plan View. Head Difference Regulating Section.
Controlling flows from fishway entrances.		FF. Power Plant With a Canal and Power Plant at Dam Face.
Location of fishway exits.		References Reviewed.
Barrier dams to divert fish to fishway system.		
Effect of high dams.		

FISHWAY STRUCTURES at Dams and Natural Obstructions

Fishways, fish passes and fish ladders are all terms used to describe methods of passing fish upstream at dams and natural obstructions. With some types of configurations, limited fish passage may be possible when the head is less than 8 feet; however, fishways are recommended when there are head differences as low as 2 feet, as blocks may be formed by insufficient water depth for swimming. (See Chapter 6, "Swimming Speeds of Adult and Juvenile Fish.")

The size of the structures, their location and the flows through them, whether at natural or man-made obstructions, should be based on the same criteria. As site conditions vary, special consideration in design is almost always required.

Of many fishway patterns, the three most commonly used are the pool and weir, the vertical slot and the Denil.

The pool and weir fishway is the oldest of the designs and is generally used at man-made structures where the head pool levels can be closely regulated. Its operation is deficient mainly in its lack of capability to operate under fluctuating operational pool levels, unless a special regulating section is provided at the upper, or discharge, end of the fishway system. (Exhibit G shows a pool and weir fishway.)

The vertical slot fishway is in common use on the Pacific Coast and in the Great Lakes area. It repeats a constant flow pattern at all operating depths and is adapted to conditions where head pool regulation is not possible. Its design is less simple than the pool and weir fishway, but its advantage is that it is self regulating. (Exhibit H shows a vertical slot fishway.)

The Denil fishway and its variations, such as the Alaska steep pass fishway, have been found to have selected application as they must be carefully engineered for width and depth relationships to provide the low velocity required in their design. They must be kept completely free from debris, as this can alter the flow characteristics of the baffles. The relationship of the baffle to the open area is critical as to width, approximately 1 to 1. These systems require more supervision than do the other two systems described. The customary slope in a Denil fishway is one to six, and an individual run is approximately 30 feet long. Resting pools between runs are required. (Exhibit I shows a Denil fishway.) The operation of the Denil fishway requires that destruction of energy created by the head difference must be divided equally among the baffles.

If shad are involved, surface and wall side passageway must be provided. This species generally rejects orifice openings at depths as low as six feet, and may become trapped in square corners. Shad also use ship-type locks for passage.

Eel passes are generally built as troughs, with anchored brush or artificial brush filling the trough space. The eels pass through the resulting passageways in the brush.

Sturgeon have not been passed successfully in pool type fishways, but lock passage is possible.

Light and shadow patterns may determine the movement of various species in a fishway system regardless of the velocity pattern.

Fish accumulate when pool hydraulic patterns are altered. If the design includes turn pools, fish will accumulate at that point. In entrance bays and transportation channels, any break in flow continuity must be avoided.

Square corners, particularly in turn pools, should be avoided as fish jump at the upwellings so created.

At sites where bed load will be encountered, either the orifice or vertical slot baffle fishway is recommended.

Trash racks may be required. If so, the clear opening must be adapted to the width of the largest fish to be passed (usually 12 inches for large salmon). There is no evidence to indicate that fish refuse to pass through trash racks at normal trash rack velocities (two feet per second or less).

Fish jumping usually is avoided by the provision of adequate swimming depth, orifices or slots. Jumping still may occur as the phenomenon is not fully understood, although it is known to be triggered by shadow patterns or upwelling. See Exhibit CC. Protective fencing may be required to prevent the fish from leaving the fishway. In narrow fishways a screened arch may be provided. Darkened fishways do not prevent movement of fish and tunnel fishways may be used. These should not be pressure conduits and head room should be provided.

Hydraulic instability occurs between the upper range of plunging flow and the lower range of shooting flow. Typical weir crests are shown on Exhibit K, with the shaped weir crest the most stable. Bottom orifices are a stabilizing influence and must be of a size capable of passing fish. The Ice Harbor weir (see Exhibit F) was developed to provide pool stability in weir type fishways. Exhibit Z shows hydraulic instability forming.

Fixed weir and orifice type fishways have limited capabilities for adjusting to pool elevation changes and can be either starved or drowned. There are a number of special pool regulating sections in use, such as orifice controls or those that depend on the addition or subtraction of pools by the use of telescopic or tilting weirs or stop logs. A regulating section has been developed to accommodate rapid pool changes. Hydraulically satisfactory designs for automatic control systems with vertical slot nonoverflow walls, bleed-off and add-in diffusers, auxiliary water supply, and movable-board underwater counting station and for revised overflow weirs downstream have been developed by models. See Exhibit EE. This section was prototype model tested and field constructed and operated. It was designed to allow for the passage of shad, but also demonstrates excellent performance for salmon passage.

A special control weir is needed if fish are to be trapped or held. This can be a V-trap arrangement, a finger trap, or a jump-over weir. A V-trap works like a tunnel in a fyke net. A finger trap is shown on Exhibit K, and one design for a jump-over weir is shown on Exhibit L. The finger trap and jump-over weir both require close water regulation. The jump-over weir is particularly useful where fish are to be sorted or delivered into an anesthetizing tank where dilution must be held to a minimum. When using finger traps, an escape area must be provided at both ends to prevent fish from being held against the fingers and killed.

The movement of the fish throughout the day is not uniform and it may be expected that between daylight and 1 p.m. as much as 60 percent of the day's run may pass,

FISHWAY STRUCTURES at Dams and Natural Obstructions

and between 1 p.m. and darkness, 40 percent. Twenty percent of a day's run has appeared in a single hour. Night counts indicate low passage (3 to 5 percent) and the early daylight hours show good passage.

Large fish (above 20 pounds) may hesitate to use shallow over-flows.

Fishway capacity normally is not a design problem, as the hydraulic criteria usually control design. (See list of pertinent fishway data.)

Adult fish approaching the base of a dam or obstruction are usually within the top 12 feet, with the most between the two- and three-foot depth levels. Fishway entrances should be positioned to take advantage of this distribution. Horizontal or vertical orifices or weirs should be adjustable to tail water changes. Methods of regulation include mechanically adjusted gates or buoyant gates.

Orifices with darkened backgrounds are not entered by the fish as readily as those with the backgrounds lighted (either naturally or artificially). The light source may be by penetration through the water from either downstream or above the orifice with the latter, under the natural conditions of daylight, producing better and longer entrance attraction.

Exhibits A, B, and C indicate the pattern of spillway operations to maintain effective conditions at a fishway entrance. In Exhibit A, all of the spillway gates are in operation, giving a crowning effect in the center of the river, and using a high velocity to guide the fish to the fishway entrances. As the flows in the river diminish and fewer open spillway gates are required, the center gates are closed first. This is shown on Exhibit B. As the flows diminish further, the gate closure is extended toward the ends of the spillway, as shown on Exhibit C. The use of center gates only for minimum spills results in attraction of fish to that area and generally this type of regulation should be avoided.

Depending on the type of energy dissipator, a submerged or surface type jump may be created. (See Exhibit D.) Fishway entrances are generally placed at or near the crest of this jump at a predetermined flood flow level. The crest position moves upstream as flow diminishes and side entrances are used to match the upstream positions. Exhibit D also shows the shortened training walls required. A leading velocity is created and picketed leads or gate manipulation is utilized to bring the fish to the bay adjacent to the fishway structure and thence into the fishway proper.

As the operation of a multiunit powerhouse is not predictable as to time of operation of specific units, a collection system may be provided which extends across the powerhouse. End entrances should be provided. Typical arrangements are shown on Exhibits R, V and W. Uneven levels in the tail race may require the use of cantilevered leaf gates in the collection system for control of the water level.

Shore located entrances are preferred as the shore line provides a lead. Eddy control is required. Fish are attracted to the discharges by both spillways and turbines, and move away from these influences during darkness hours when they may seek velocities of one foot per second or less for resting. The early morning movement of the returning fish to the obstruction appears to produce the greatest activity

in the fishway. Casual discharges at any time may attract fish, and they may remain in the general vicinity for hours after the flow is cut off. Intermittent spills can be used to attract fish to desired locations.

Flows from the fishway entrances may be augmented by auxiliary water introduced either into an entrance bay or a collection system, in which case an entrance discharge can be made up, thus permitting continuation of the transportation flow. Exhibits P, Q and V show typical arrangements for bottom diffusers. Side diffusers may be used but it is more difficult to provide uniform velocities through them, and they require special directional vanes. Gratings over the diffusers are utilized to prevent the fish from entering the large discharge area, with subsequent delay in movement.

Transportation flows are required in flat runs, such as collection systems and drowned-out portions of a fishway, because of rising tail water. Auxiliary water is introduced into the drowned-out pools as shown in Exhibit D, section B-B. Designs have been developed to supply or reduce the flows automatically as the tail water rises and falls.

Fishway exits are customarily placed well above any possible drawdown effect, or away from strong currents. A slight positive downstream current for leading is advantageous. Under the most favorable conditions, some fish are still found to drop downstream through fishways or turbines (perhaps up to 4 percent of a day's run). This wandering phenomenon is not understood; however, drop backs may include fish that have moved above their home streams.

Barrier dams, specially constructed to divert fish to a fishway system, are now being used under certain project conditions, as restricted spillway areas, widely fluctuating tail water levels, economics, and at projects where collecting, sorting and hauling are necessary. Exhibit BB shows a barrier connected with a fishway at a natural falls. Special hydraulic conditions are created to lead the fish to the entrances. (See Chapter 26, "Artificial Guidance of Fish," Exhibits I and J.)

High dams have complicated the designs for fishways as fish have rejected fishways systems that use surface flows with the principal discharge of the river supplied from deep outlets. This phenomenon is not fully understood. Temperature and water quality (including taste and odor) are considered to be principal factors.

Counting stations may be required. The most simple type counts fish over a weir. Fish may be more readily seen against a white painted counting board. A V-lead to an adjustable counting board has been in general use; more recent advances in design use an underwater station at which fish are directed to pass near a glass window. Back panel lighting may be provided in addition to surface lighting. Television counting is possible at such stations, with the fish activating the camera as they pass through a resistance tunnel. The presence of people at these underwater stations appears to have no influence on the movement of fish and public view windows are provided at some dams.

Counting stations may be located within the fishway system or at the outlet or exit end. Because of the changing hydraulic patterns, fish tend to linger above a counting station area and frequently move back and forth. Counting

FISHWAY STRUCTURES at Dams and Natural Obstructions

stations at the exit end minimize this movement. White areas also appear to alarm fish, with some turning back before they have completely crossed the painted area.

The closure of counting stations results in accumulation of fish below the stations. It is recommended that an extra large pool be provided below any counting station. Most counting stations provide for an adjustable distance between the fish and the observer to compensate for water clarity where species identification is desired.

Many designs for counting stations are available.

There are no fish locks in operation on the Pacific Coast. Those that were constructed in the past were operated in conjunction with fishways. All lock operations have been discontinued in favor of fishway passage. (See Chapter 33, "Locks and Mechanical Handling.")

Exhibits P, Q, T and U show the general configuration of locks in relation to the total fishway systems and a progression of development. Exhibit Q shows a paired set of locks with entrances at entrance bay level and with no holding pool. Exhibits P, T and U show fish locks located above the entrance bay level which provides a short run of fishway to an entrance pool. The McNary Dam lock chamber shown on Exhibit P was used during construction for transporting fish by bucket into the lock chamber, which demonstrated the fact that this system was capable of collecting and holding fish. Present day entrance pools would have a crowder, for which there are several designs, such as a sweep moving along a track. In principle, they insure the movement of the fish out of the entrance pool without a time delay.

Deep reservoirs in river areas cause problems to fish migrations, both adults and juveniles, through the slack waters. Temperature is a factor in migration and salmonoid fish will leave a warmed surface to seek cooler depths. In many of the reservoirs south of the 45th parallel and east of the modifying coastal conditions, areas of low oxygen level have formed below the thermocline. The environmental conditions, therefore, in such half lakes are such that either the temperature or the oxygen level may inhibit the migration or residence of cold water fish. The lack of leading velocities in reservoirs to fish that are accustomed to river conditions has caused wandering, both up and downstream, in search of an exit from the reservoir. This behavior pattern at this time is not understood, as certain of the salmonoid species accustomed to passing through lake areas continue to home without the apparent problems of wandering demonstrated by the river-accustomed fish. Delay by wandering can be fatal because of the energy utilization. (See pages 5.1 and 5.2 of Chapter 5, "Useful factors in Life History of Most Common Species," and pages 7.1 and 7.2 of Chapter 7, "Spawning Criteria.") It is recommended that all factors pertaining to fish passage at high dams be completely explored before considering any upstream passage system. Attempts to move downstream migrants from reservoirs have not met with universal success. Floating surface type collectors have been successful in two reservoirs. In one, a variable depth collector, as shown on Exhibit M, has been successful in capturing migrants. Experiments indicate that fish will pass under surface collectors when following their desired temperature gradient. Multilevel or adjustable depth entrances make possible attraction at varying temperature levels. (See

Chapter 18, "Avoidance," Chapter 26, "Artificial Guidance of Fish," Chapter 11, "Temperature - Effects on Fish," and Chapter 24, "Movement of Downstream Migrants.")

Special downstream passage is not usually provided at low head dams (100 feet or less). (See Chapter 25, "Passage of Fish Through Turbines, Spillways and Conduits.")

Models may be used to predetermine many project conditions and to permit design alterations to favor fish passage. The location of the jump crest for various river flows can be determined by models such as shown on Exhibit DD.

Nitrogen entrainment may occur under many spillway conditions. This factor requires special consideration as the depth of water in the stilling basin is a major factor in concentrating entrained nitrogen.

The same criteria should be applied in the design of temporary fishways that are used during periods of construction as for permanent structures, although the structural materials used may be less durable. In lieu of fishways, a diversion tunnel or open by-pass may be used to pass fish, if suitable swimming velocities can be maintained. (See Chapter 6, "Swimming Speeds of Adult and Juvenile Fish.") As construction procedures vary, each project must be evaluated as to potential blocking conditions that may be created during construction. Temporary trapping and hauling have been used as a means of passing fish during construction periods. Such facilities should be designed in accordance with the criteria in Chapter 33, "Locks and Mechanical Handling."

Low head dams are being retrofitted for development of hydroelectric power. If the retrofitting requires licensing or permits, which include fish protection, then the criteria are the same as for a new project.

Exhibit FF shows general configurations of a low head dam, with a powerhouse downstream to take advantage of any rapids or falls and a powerhouse connected to a dam.

In the first case, the use of a fishway for upstream passage would require that the installation be adjacent to the powerwheel discharge. The conditions within the canal must be such that adult fish could pass through the canal to the head pool.

In the second case, the powerhouse is adjacent to the dam, and a fishway at that location would exit into the head pool.

In both cases, if there were an attractive over-spill, a second fishway would be required, particularly in the first case, where fish would collect below the dam and would not necessarily move downstream after once passing the powerhouse discharge. In the second case, the connection between the stilling pool and the powerhouse discharge would allow fish that would accumulate below the dam, if there were a spill, to move into the tailrace area.

Exhibit FF shows potential locations for screening, if downstream moving fish require protection.

Complete details of the project and its operation must be made available to permit adequate design of any facilities to protect fish at low head plants.

FISHWAY STRUCTURES at Dams and Natural Obstructions

Fishway Design Data

To aid the designer, a check list of pertinent fishway data follows.

Pool sizes and shapes.	See Exhibits E, F, G, H, and I.	Space for fish in pool.	.2 cubic foot per pound of fish.
Maximum flows in fishways (energy must be dissipated in each pool).	Based on energy dissipation of 4 foot pounds per second per cubic foot of water in pool, or a velocity of 4-5 fps in Denil type.	Space in trapping or holding area.	1.5 cubic foot per 5 pounds of fish.
Resting areas.	Assumed to be velocities of 1 fps or less in pools, or 0.1 of normal swimming speed. Denil requires special resting pools.	Peaking of salmonoid fish during passage.	Assume 60% from daylight to 1 PM and 40% from 1 PM to darkness. Night passage may equal 3 to 5% of day's total.
Orifices (number and size).	One to two per pool may be used.	Entrance eddies.	Recommended that cross velocity not exceed 2 fps at zero fishway discharge. Less if small fish are to be passed.
Discharge volume through a vertical slot or per square foot of orifice.	See Exhibit J.	Auxiliary water introduction into fishway for entrance attraction or transportation velocities.	Velocities over diffusion area, .25 to 1.0 fps.
Drop between pools.	12 inches, but should be tailored to requirements of species to be passed, or sloped for Denil type.	Grated openings.	Usually 1/4-inch less than minimum fish head width of species to be passed, with 50% of area assumed to pass flow.
Average maximum velocities over weirs or through orifices.	8 fps maximum, or based on drop per pool. Maximum of 4-5 fps in Denil.	Counting stations.	Described in text.
Entrance velocities.	4 to 8 fps.	Control section to match forebay regulations for pool type fishway.	Described in text.
Water depth as a weir measurement over a pool weir.	6 inches minimum and 12 inches maximum.	Collection system.	Described in text.
Transportation or directional flow velocities in flat areas or drowned-out areas of fishways.	1 to 2 fps.	Temporary fishways during construction.	Described in text.
Exit locations.	See Exhibits A, B, C, N, Q, BB.	Source of auxiliary water supply.	Gravity (with energy dissipators), pumps or special turbines.
Travel time through fishway.	Assume 2.5 to 4 minutes per pool, or 15 seconds in a Denil swim section. Denil should provide equivalent time in resting pools.	Fish locks and lifts.	See Exhibits T and U and description in text.

FISHWAY STRUCTURES at Dams and Natural Obstructions

A

Typical Layout for Fishway at Power Dams

All Gates Open with Crowned Operation - By Restricted End Gate Openings

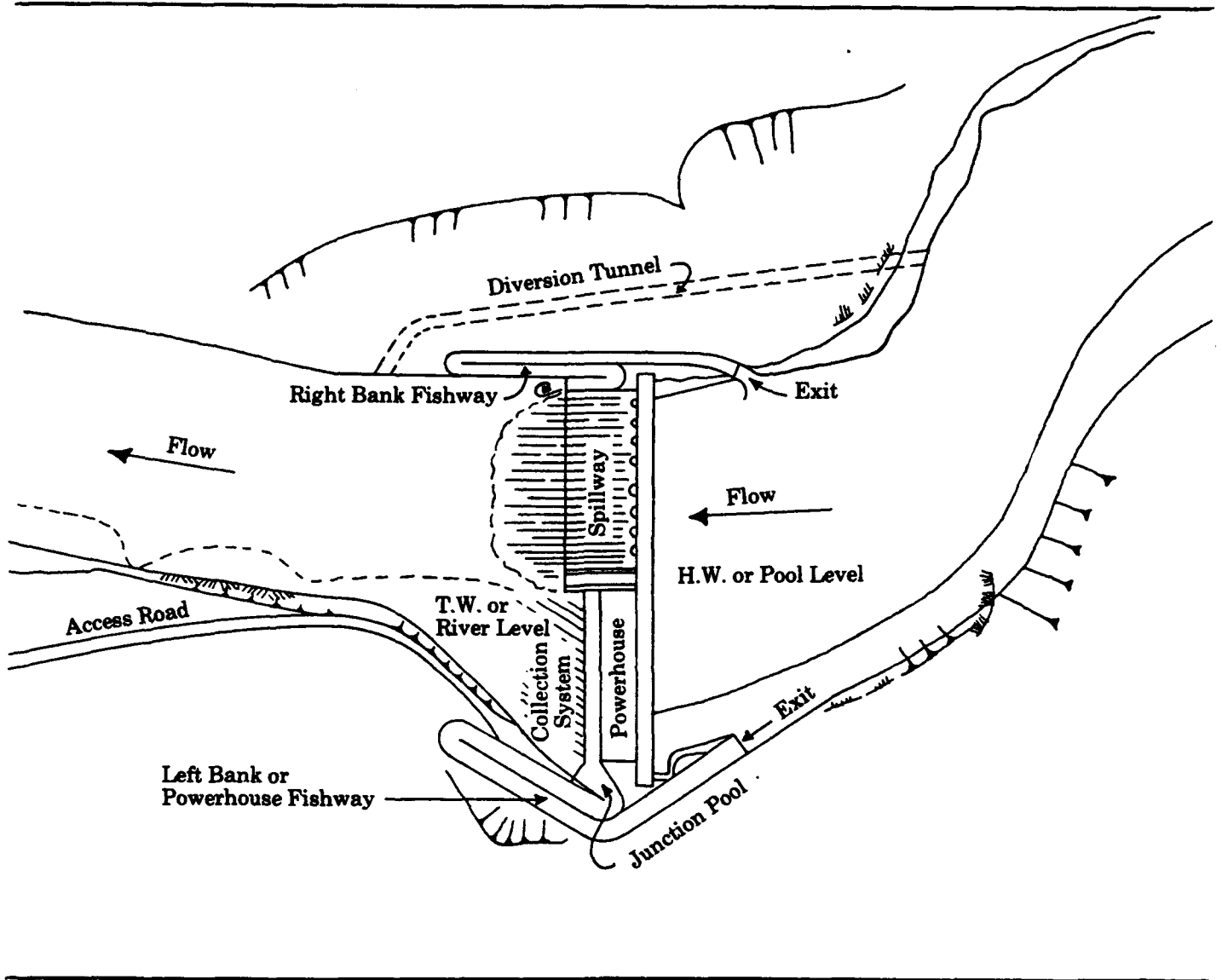

FISHWAY STRUCTURES at Dams and Natural Obstructions

B Typical Layout for Fishway at Power Dams Limited Spill Regulation - Expanded as Flow Increases

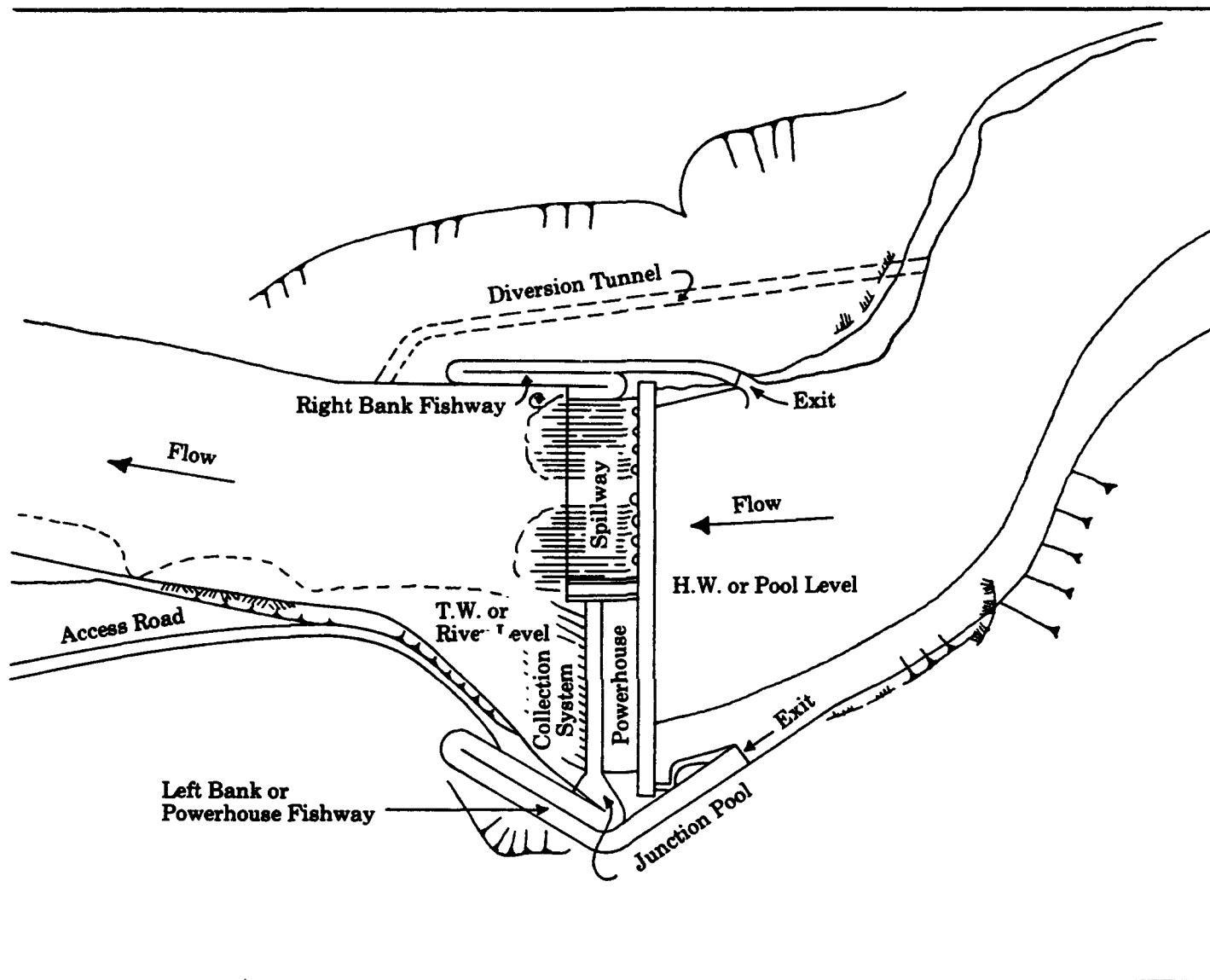

FISHWAY STRUCTURES at Dams and Natural Obstructions

C
Typical Layout for Fishway at Power Dams
Limited Spill Regulation - Side Gates Open Only

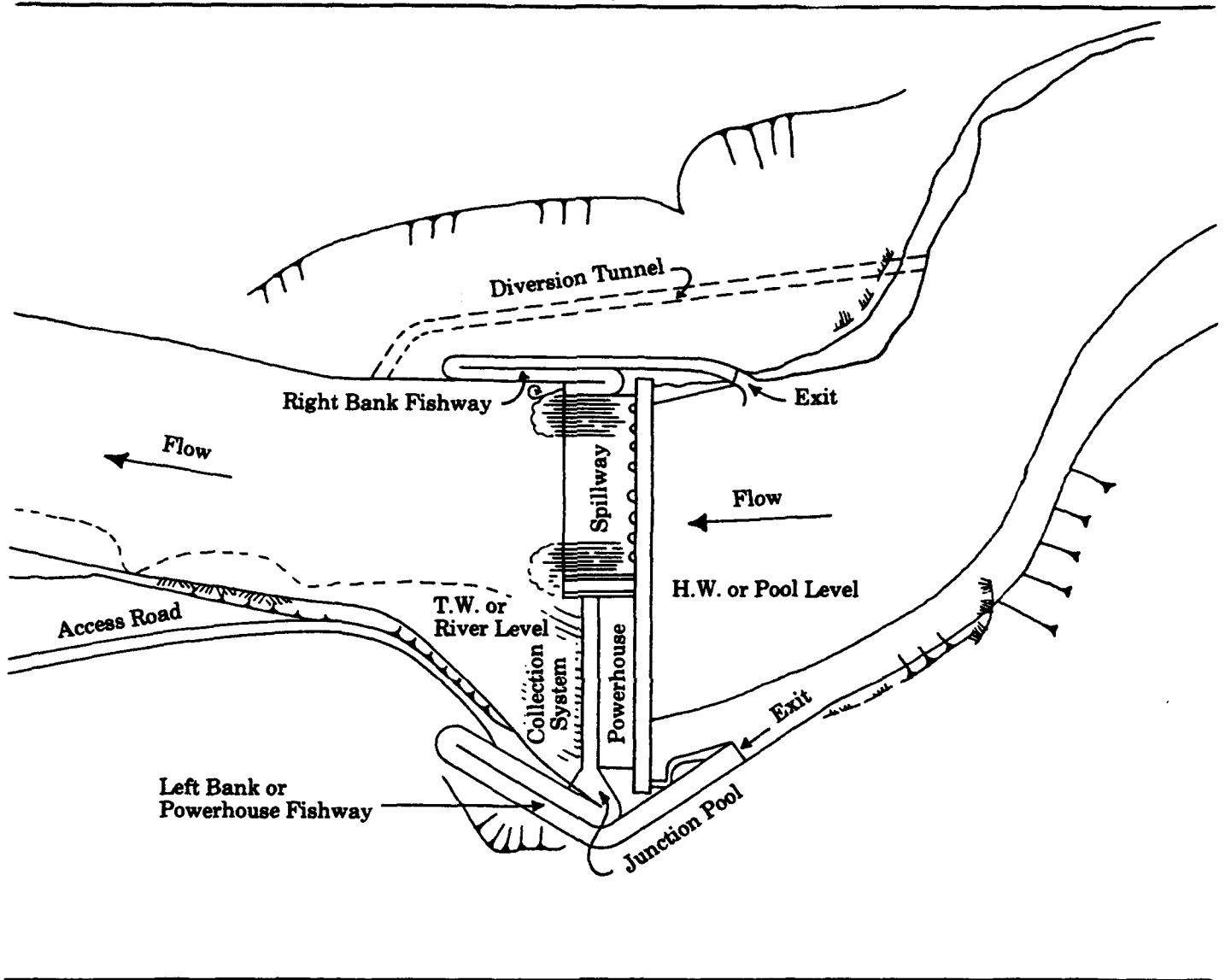

FISHWAY STRUCTURES at Dams and Natural Obstructions

D Typical Spillway Fishway Entrance

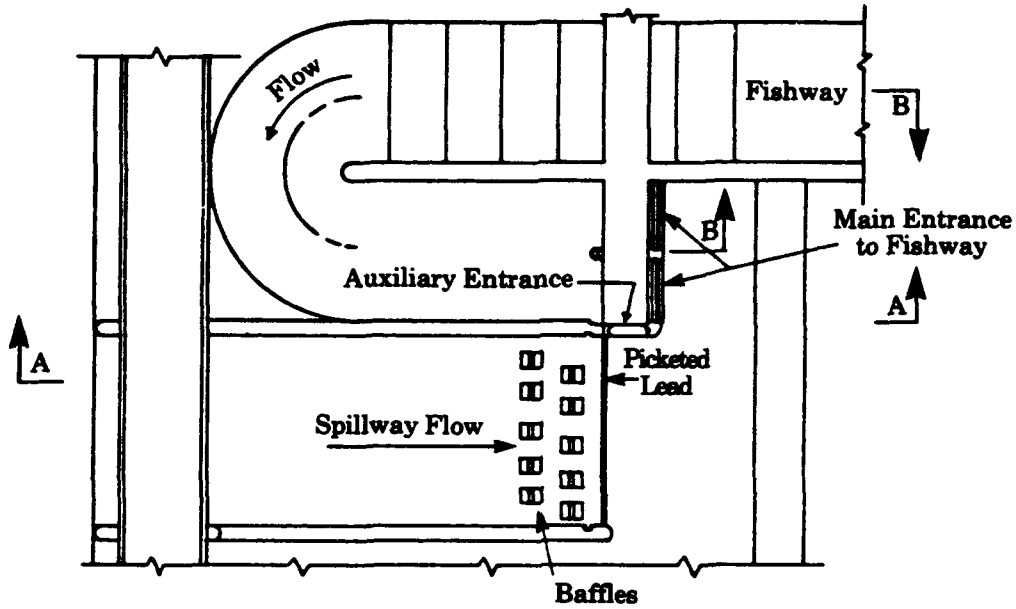

Plan

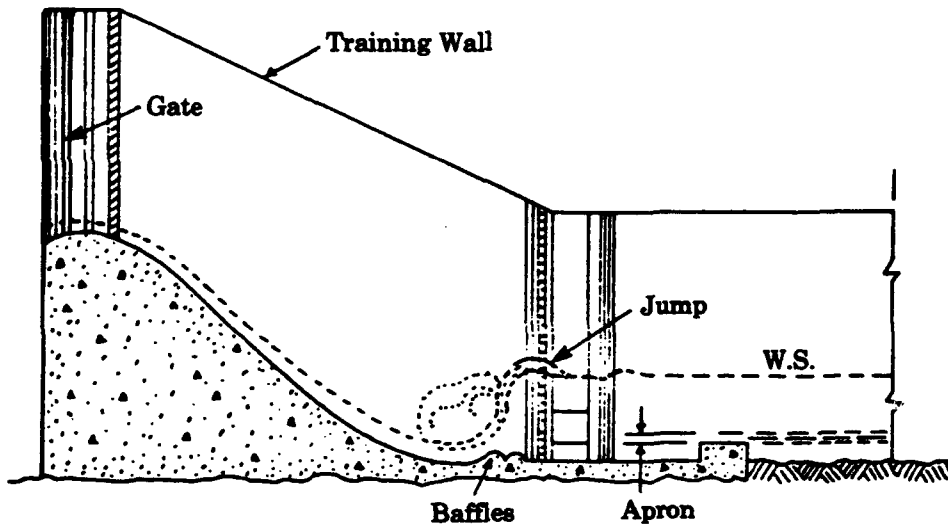

Section A-A

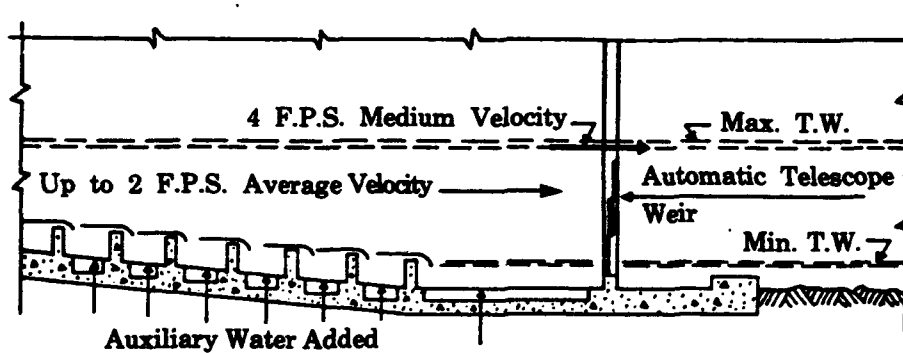

Section B-B

FISHWAY STRUCTURES at Dams and Natural Obstructions

E Streaming or Shooting Flow

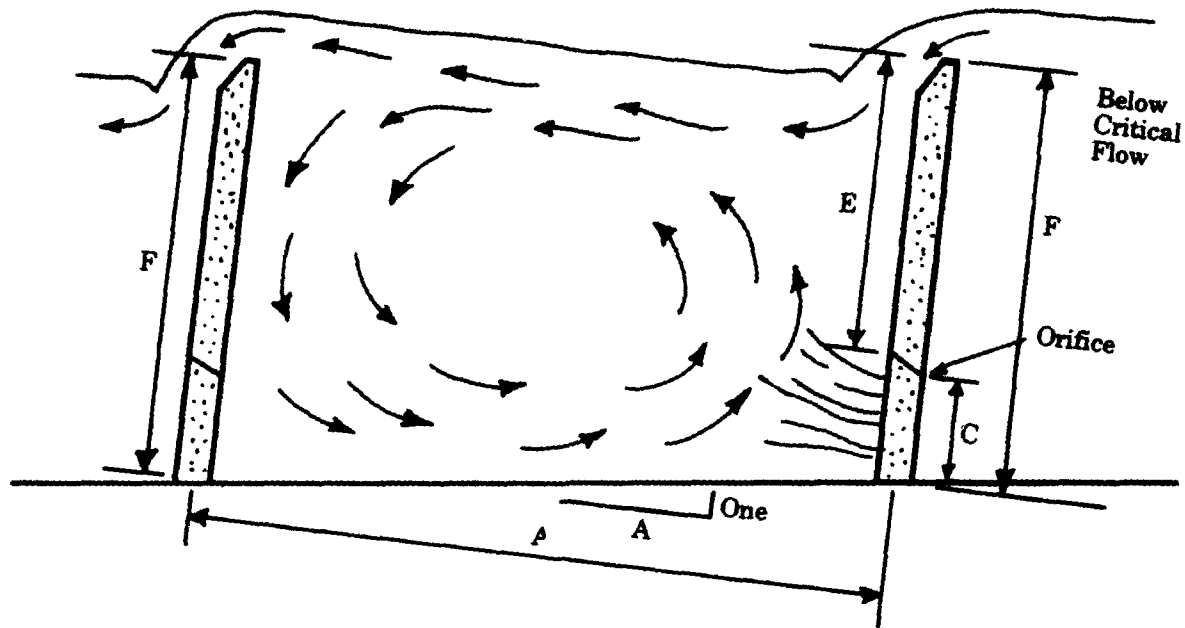

Plunging Flow

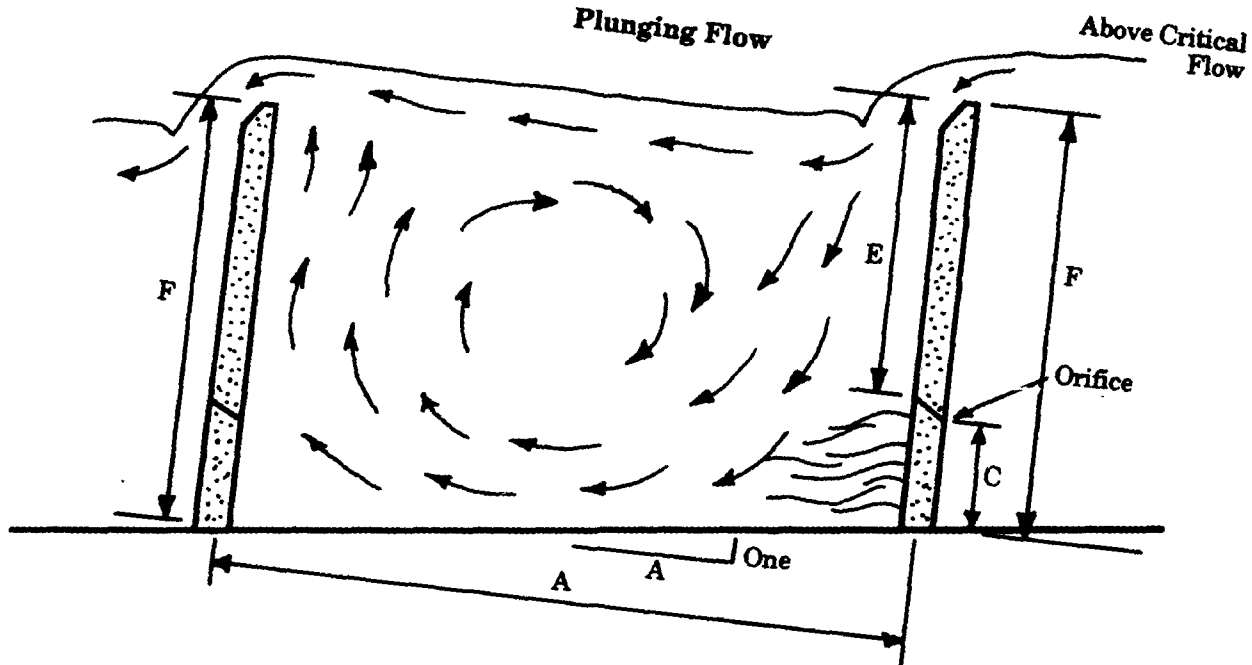

A	Pool Length	6-20 Ft.
B	Pool Width	6-20 Ft.
C	Orifice Height	18"
D	Orifice Width	15"-18"
E	Position of Orifice Vertically	4.25 Ft.
F	Weir Height	6 Ft.
Drop Per Pool		12" Maximum

FISHWAY STRUCTURES at Dams and Natural Obstructions

Ice Harbor Weir Crest

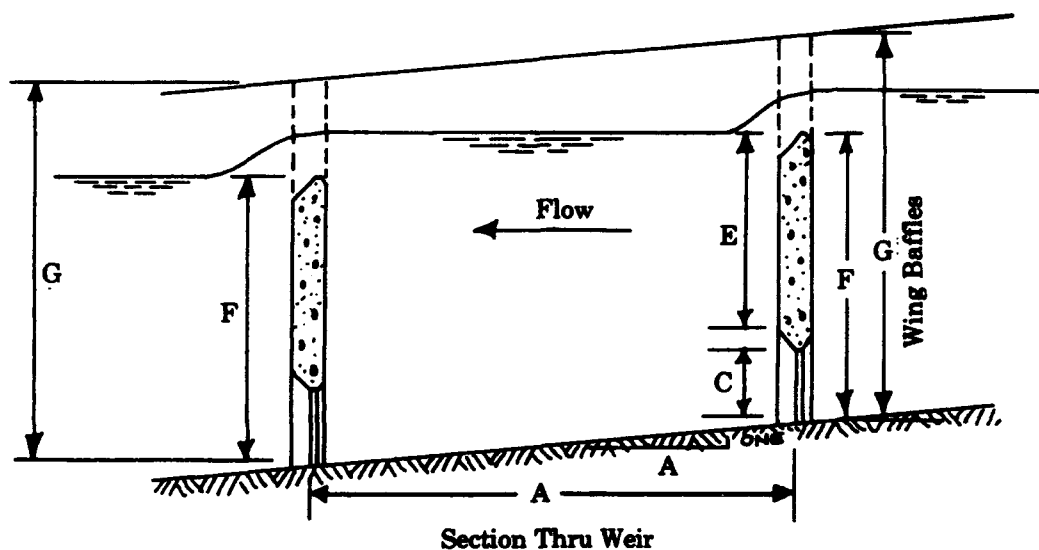
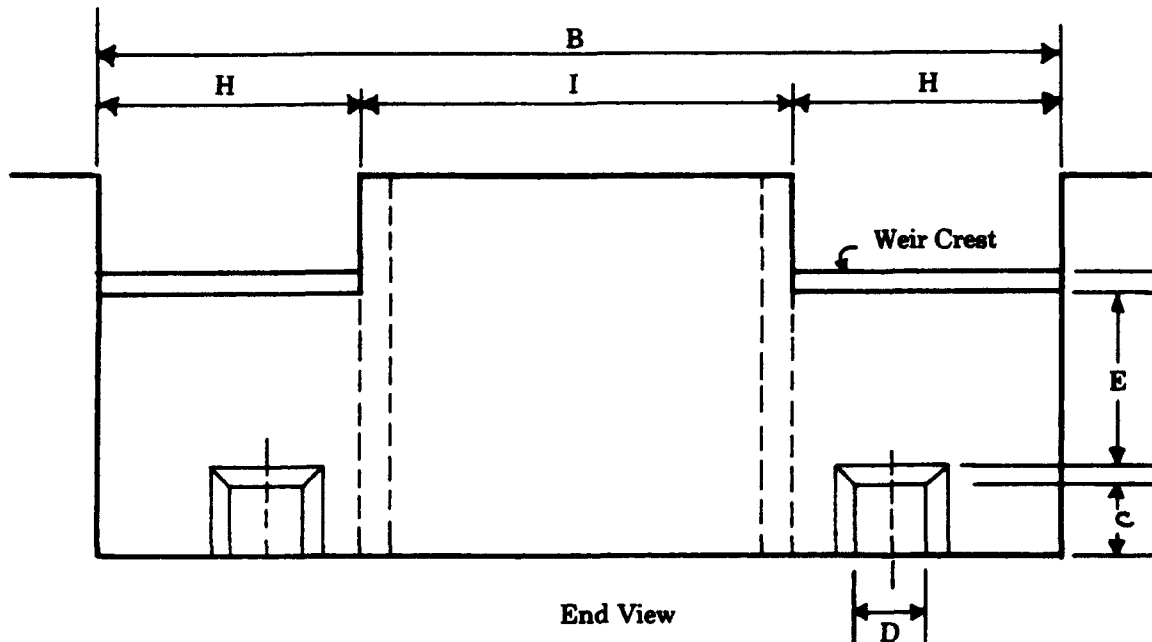

A	Pool Length	8-20 Ft.
B	Pool Width	6-20 Ft.
C	Orifice Height	18 In.
D	Orifice Width	15 In.
E	Position of Orifice Vertically	4.25 Ft.
F	Weir Height	6 Ft.
G	Wing Baffle Height	8 Ft.
H	Position of Wing Baffle	1.5-5 Ft.
I	Width	1/2 of B

FISHWAY STRUCTURES at Dams and Natural Obstructions

G Pool and Weir Fishway

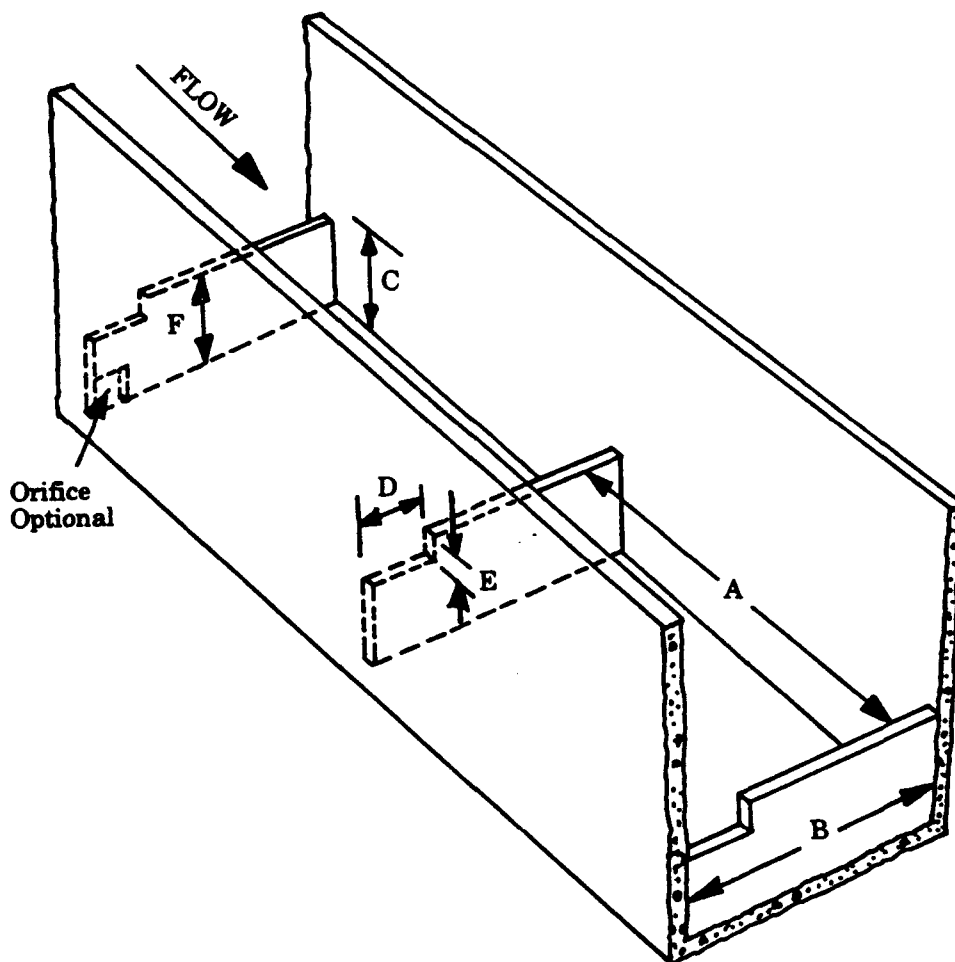

A	Pool Length	6'	8'	10'
B	Pool Width	4'	6'	8'
C	Water Depth	3'	4'	6'
D	Slot Width	.5'	.5'	.5'
E	Slot Depth	.5'	.5'	.5'
F	Baffle Height	2.5'	3.5'	5.25'
	Water Depth in Notch	12"	12"	15"
	Discharge in CFS	Min	4.0	4.0
		Normal	5.0	12.3
		Max.	24.0	36.0
	Drop Per Pool	1'	1'	1'

FISHWAY STRUCTURES at Dams and Natural Obstructions

H Vertical Slot Fishway

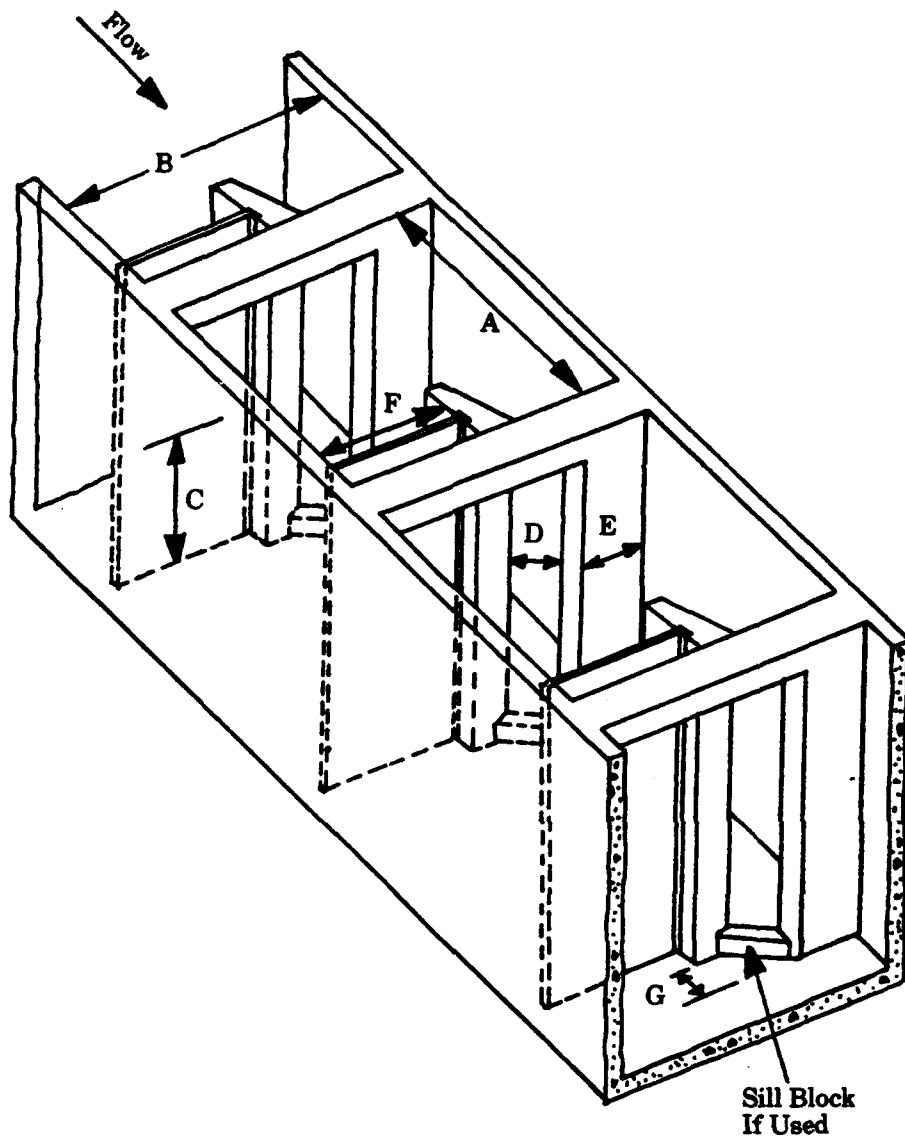

A Pool Length	6'	8'	10'
B Pool Width	4'	6'	8'
C Water depth (Min)	2'	3'	3'
D Slot Width	.5*	.75*	1.0*
E Wing Baffle Length	9"	1'-3 $\frac{3}{8}$ "	1'-3 $\frac{3}{8}$ "
F Wing Baffle Distance	2'	3'-1"	3'-7"
G Displacement of Baffle	4'	5'- $\frac{1}{2}$ "	5'- $\frac{1}{2}$ "
Discharge Per Foot of Depth Above Block in CFS	3.2	4.8	6.4
Drop Per Pool	1'	1'	1'

*Sill Block
in Place

FISHWAY STRUCTURES at Dams and Natural Obstructions

I Denil Fishway

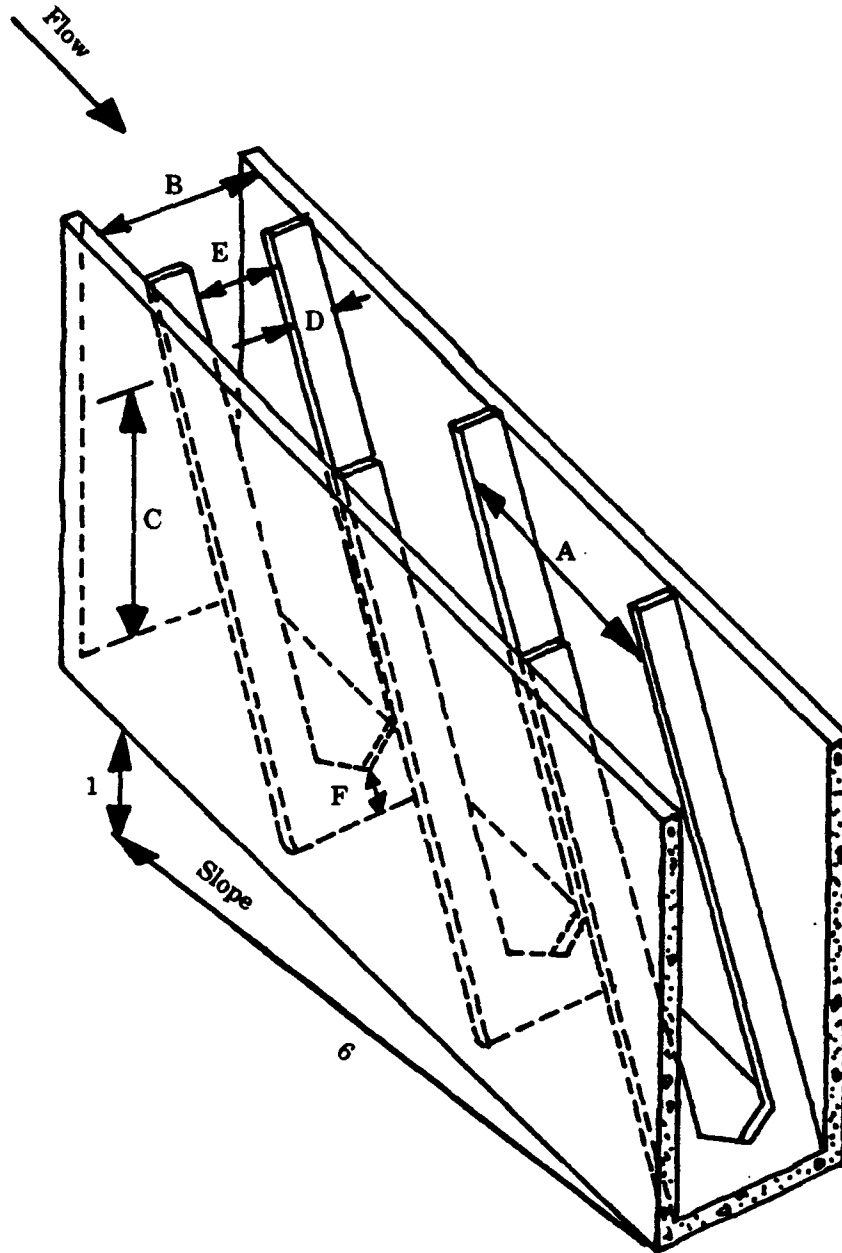

A	Pool Length	2'
B	Pool Width	3'
C	Water Depth	3'
D	Baffle Width	7.5"
E	Slot Width	1.75'
F	Bottom Baffle Notch Ht.	7"
	Discharge Variable CFS —	21
	Av. Vel. 4 FPS	

FISHWAY STRUCTURES at Dams and Natural Obstructions

J Discharge for Single Slot Fishway

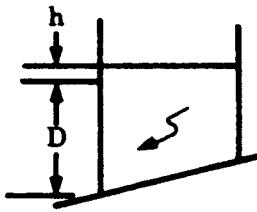

D = Pool Depth (Ft.)
h = Head Per Baffle (Ft.)
W = Slot Width (Ins.)

$C_d = 0.75$, Slot 12" Wide

For Other Conditions $Q = \frac{C_d}{0.75} \frac{W}{12} Q_0$

Computed from $Q = C_d (Dh) \frac{W}{12} \sqrt{2gh}$

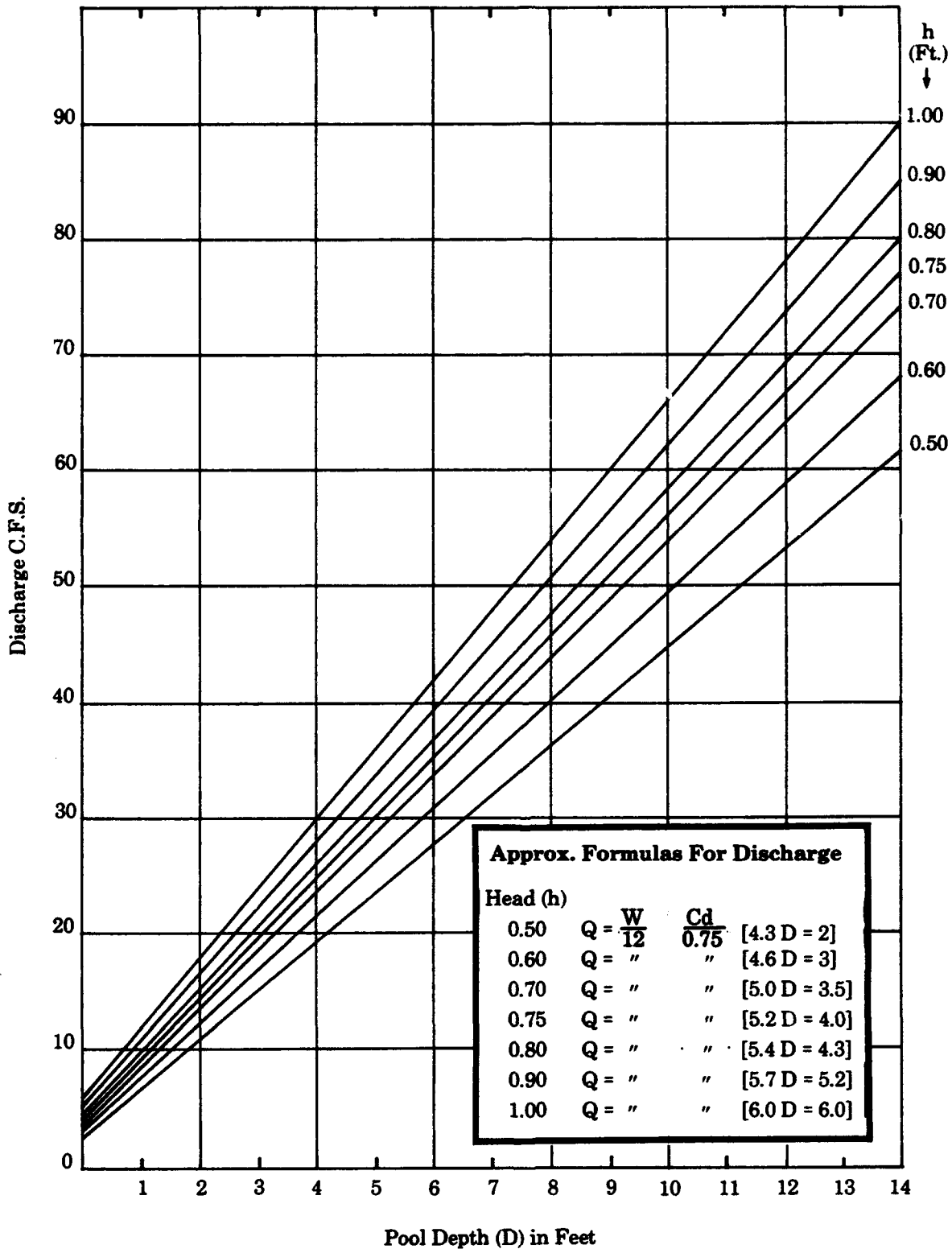

Washington Department of Fisheries

FISHWAY STRUCTURES at Dams and Natural Obstructions

K Finger Trap

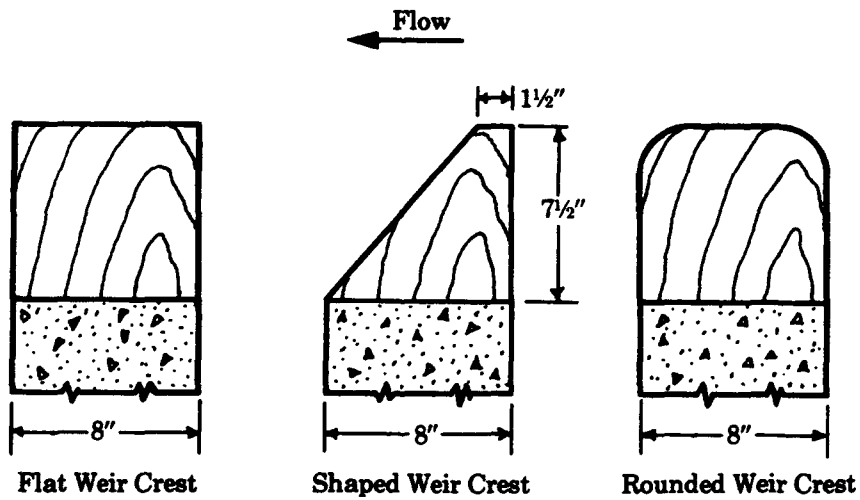
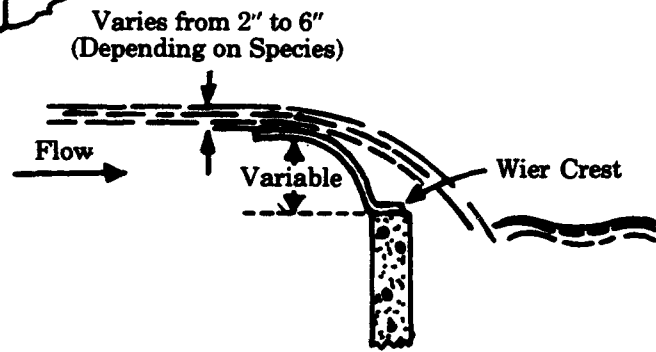
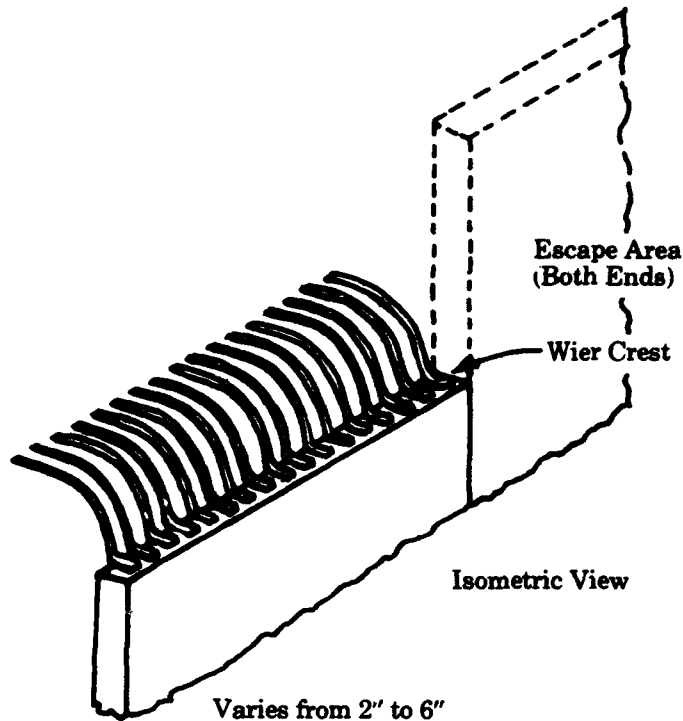

FISHWAY STRUCTURES at Dams and Natural Obstructions

L Cross Section Through False Weir

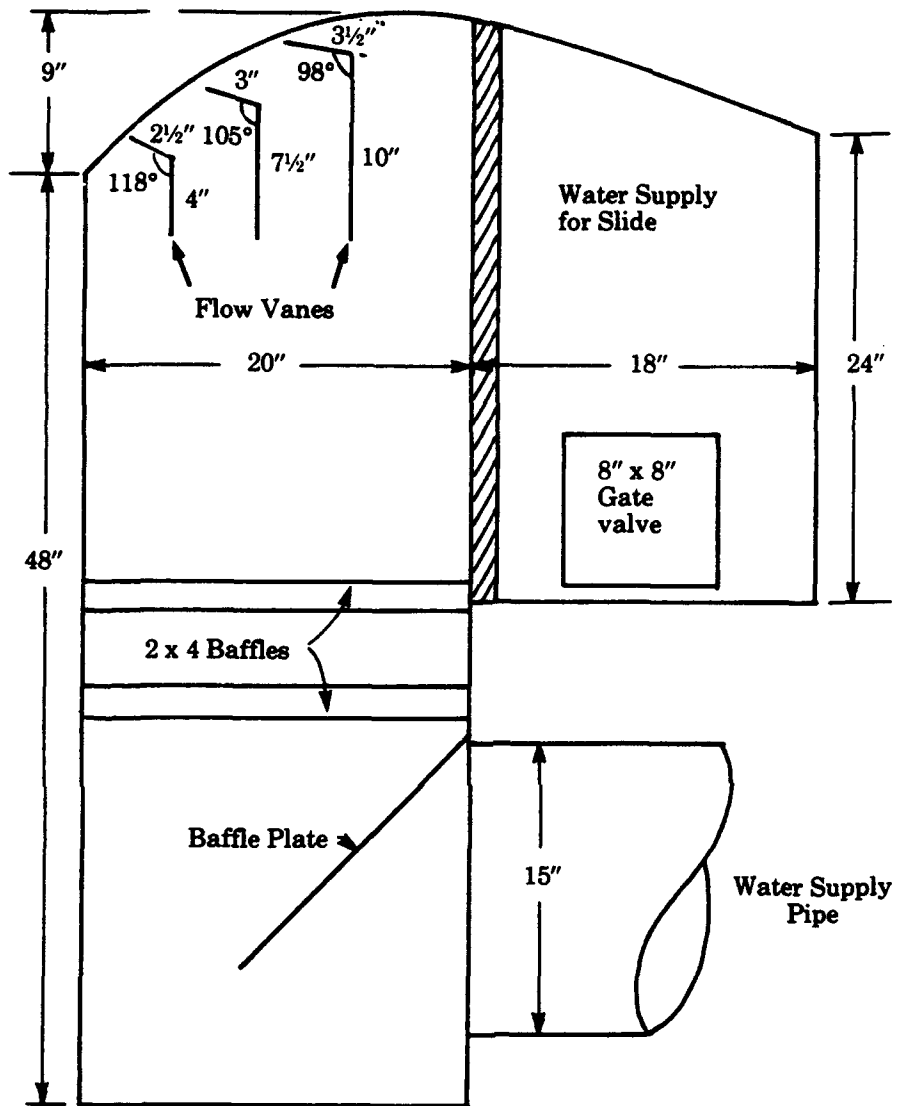

Progress Report No. 110, U.S. Fish & Wildlife Service, Seattle, Washington. 1964.

FISHWAY STRUCTURES at Dams and Natural Obstructions

M

A Down Stream Passage Facility Used at a High Dam
(Supporting Framework and Hoisting Mechanism Omitted)

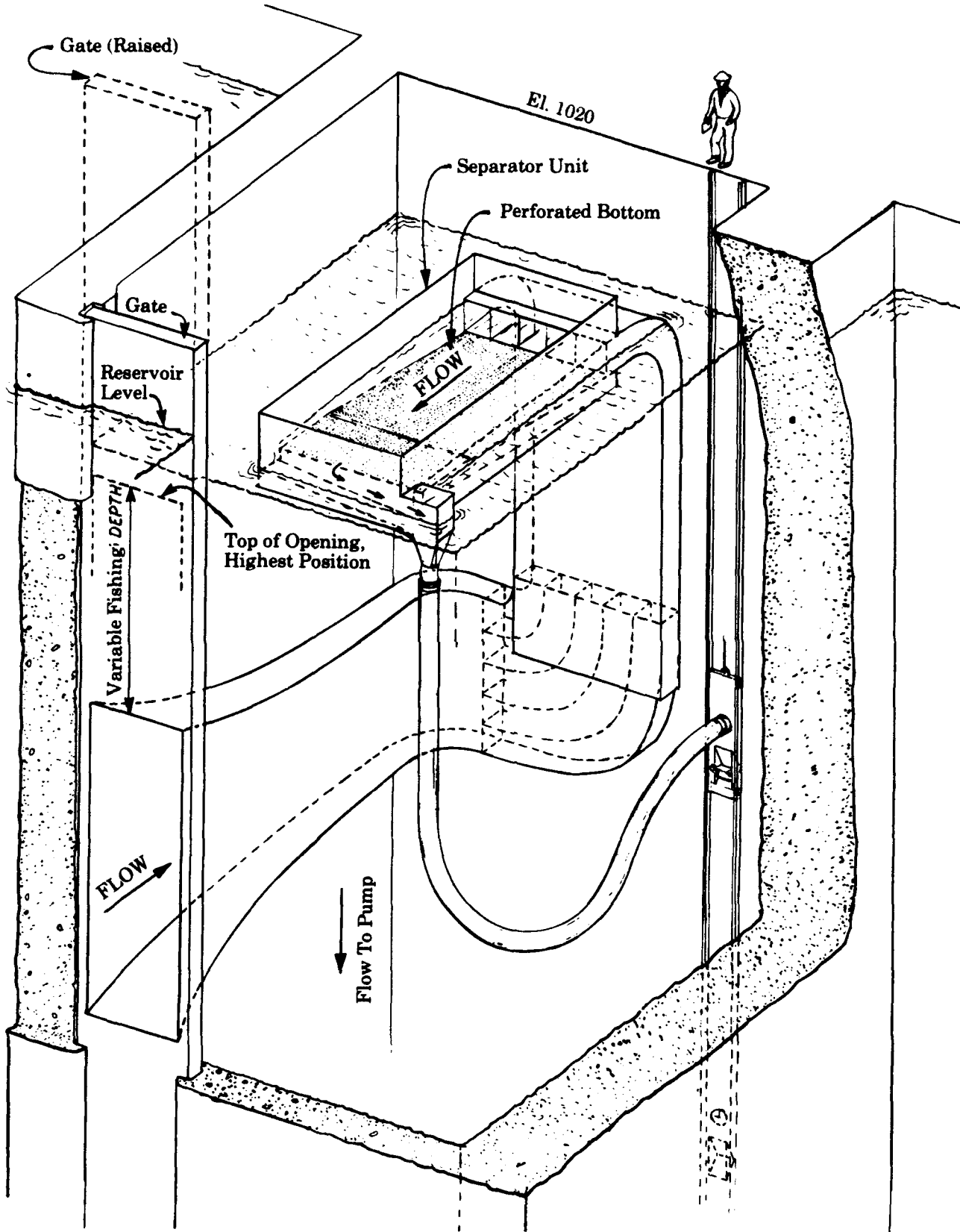

Corps of Engineers, Portland District

N
The Dalles Dam
Corps of Engineers, Portland District

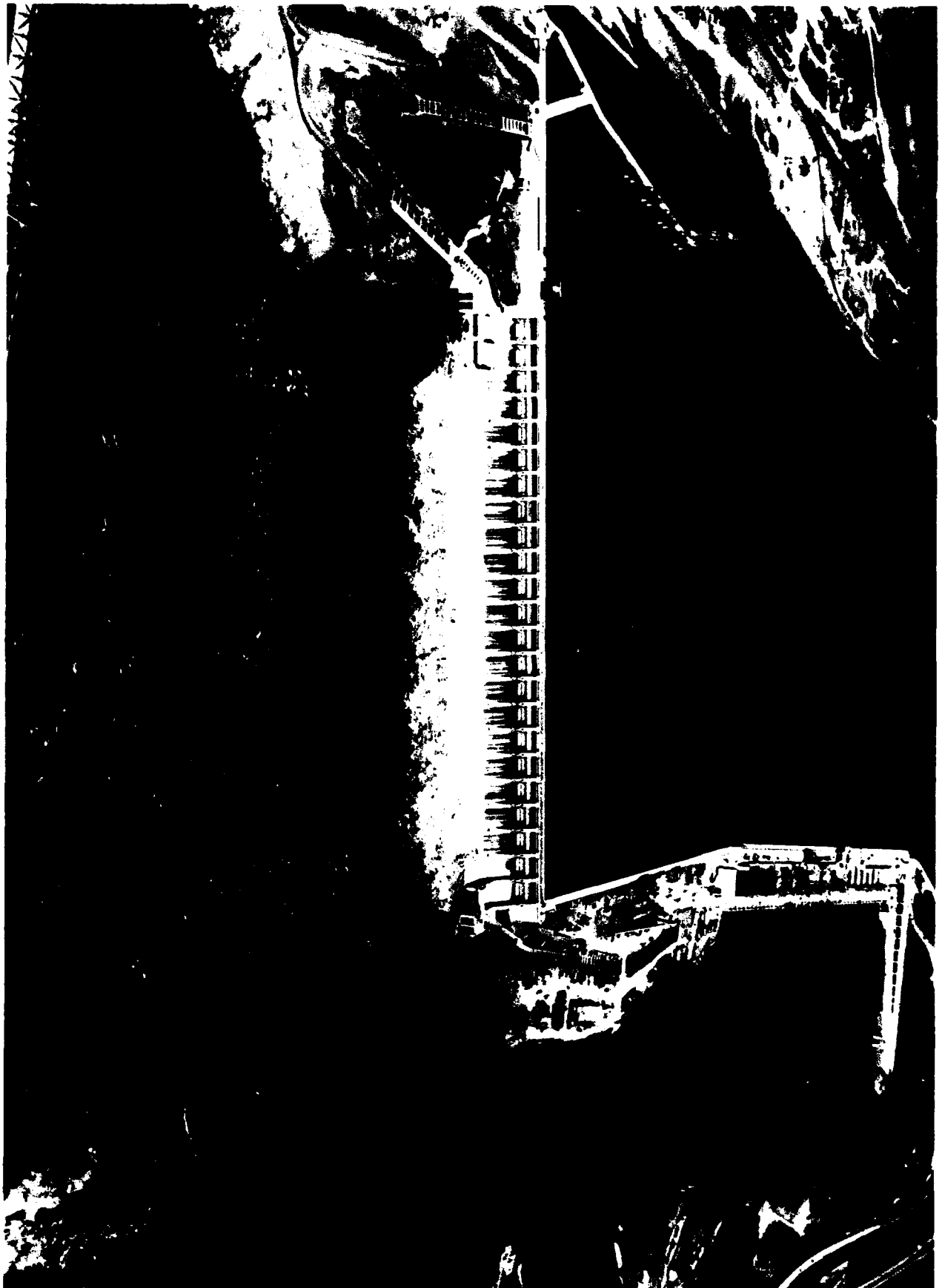

O
Dexter Dam
Corps of Engineers, Portland District

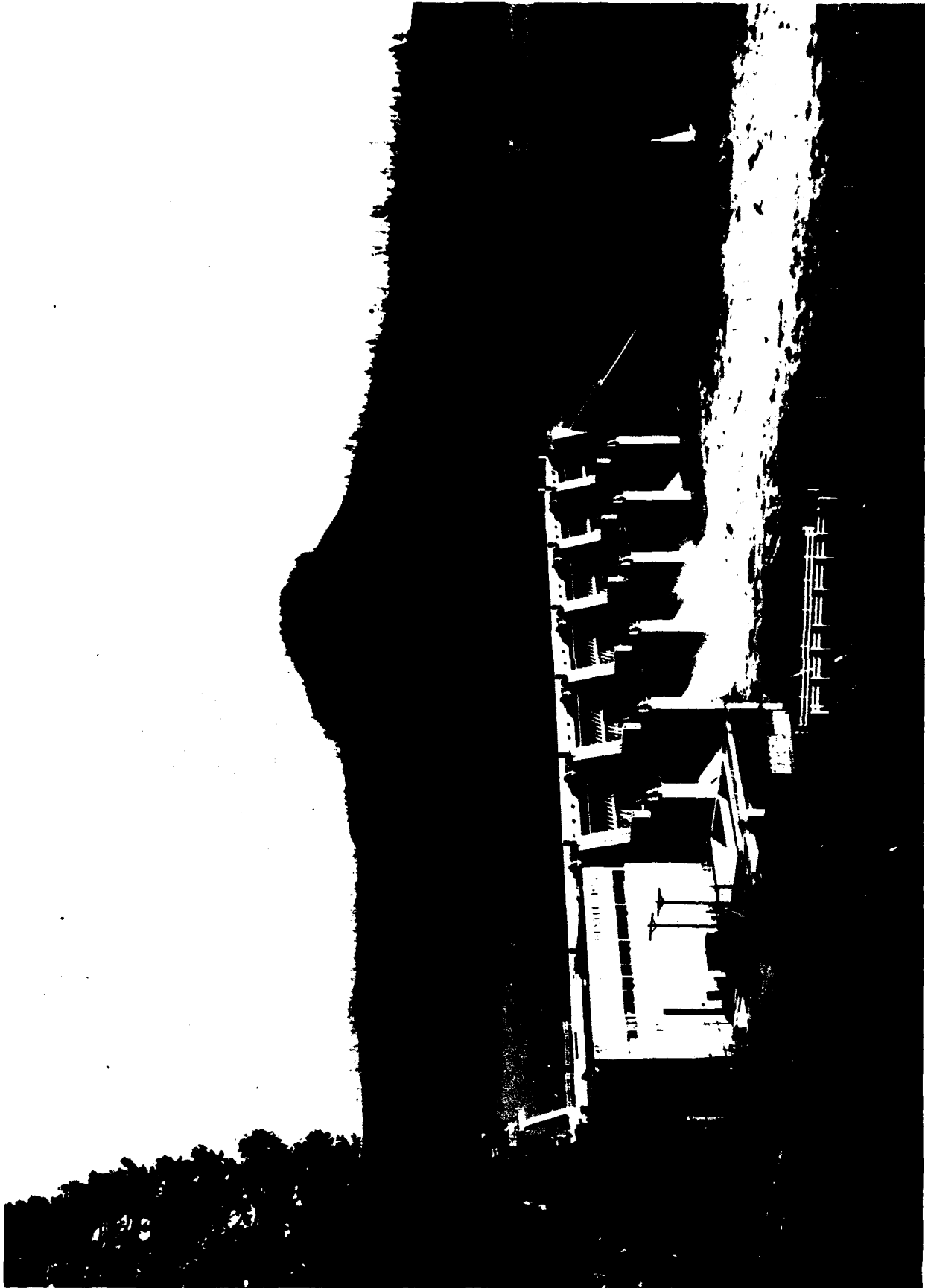

P
McNary Dam - Washington Shore Fish Ladder - Lower Section
Corps of Engineers, Walla District

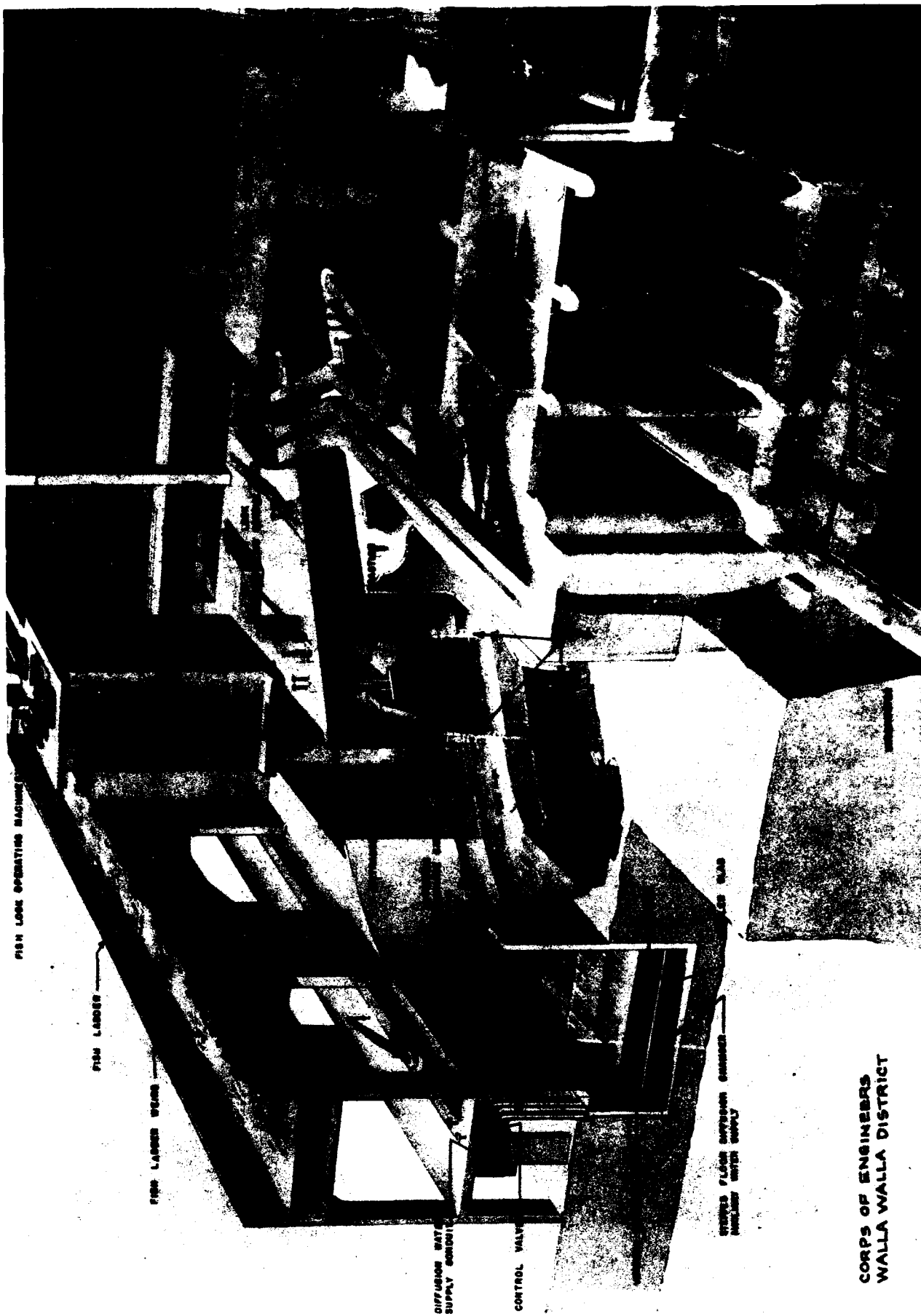

CORPS OF ENGINEERS
WALLA WALLA DISTRICT

FISHWAY STRUCTURES at Dams and Natural Obstructions

Q
Bonneville Dam - Fish Passing Facilities
Corps of Engineers, Portland District

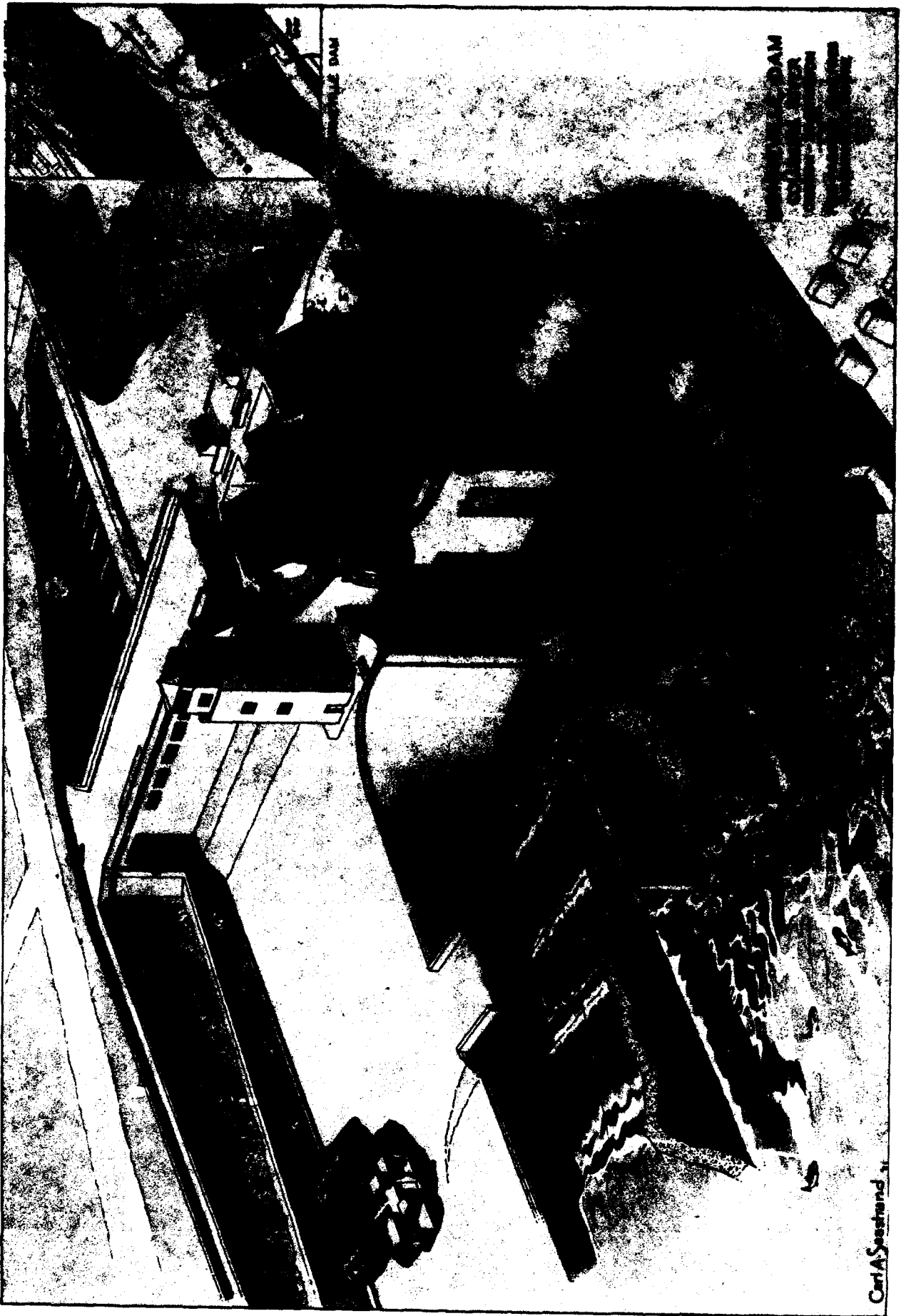

FISHWAY STRUCTURES at Dams and Natural Obstructions

R
The Dalles Dam - Fish Water Supply Turbines
Corps of Engineers, Portland District

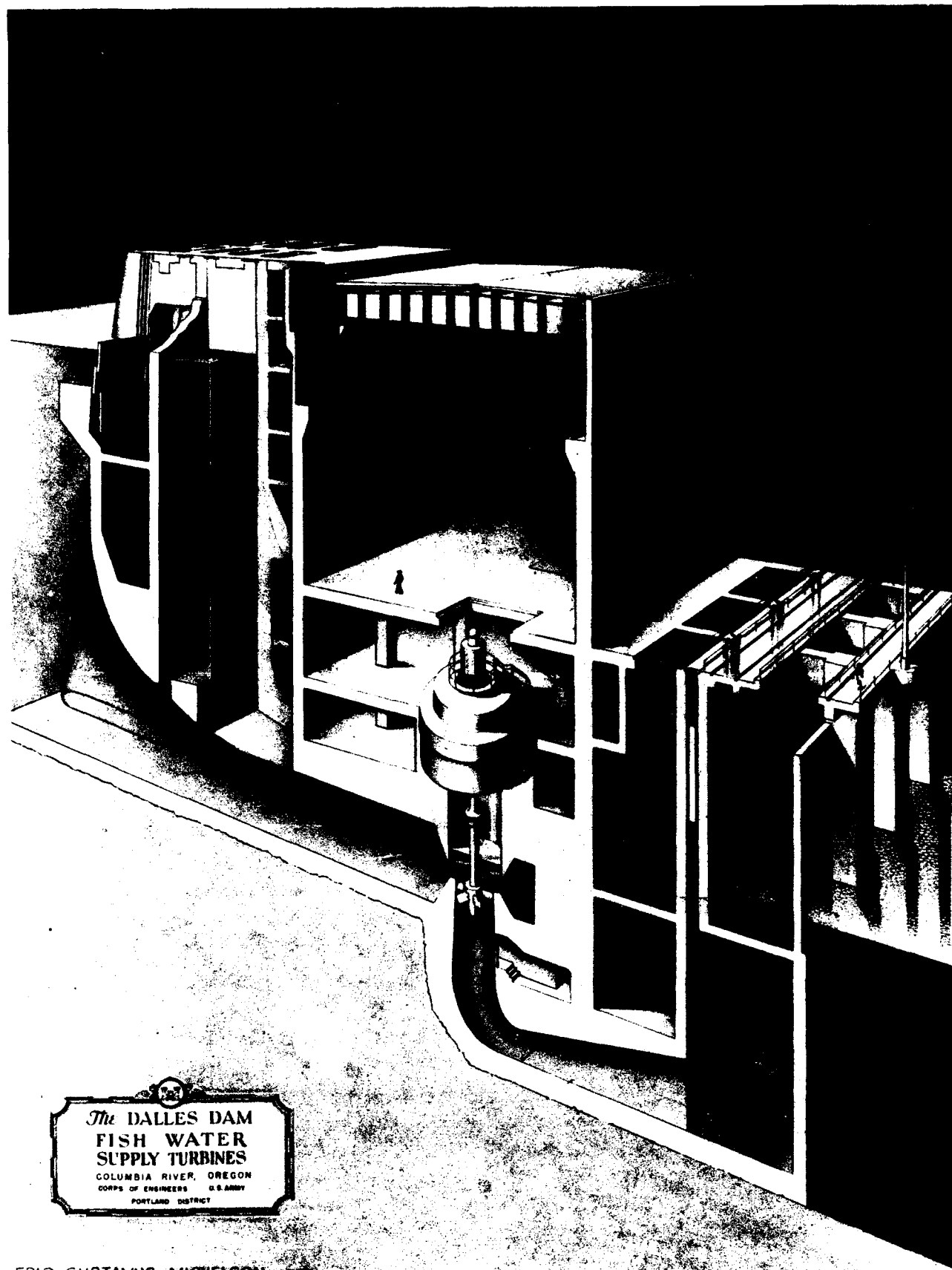

ERIC GUSTAVUS MICHELSON 1935

FISHWAY STRUCTURES at Dams and Natural Obstructions

S
Fishway Turbine Pump
Chelan County Public Utility District
Rocky Reach Project

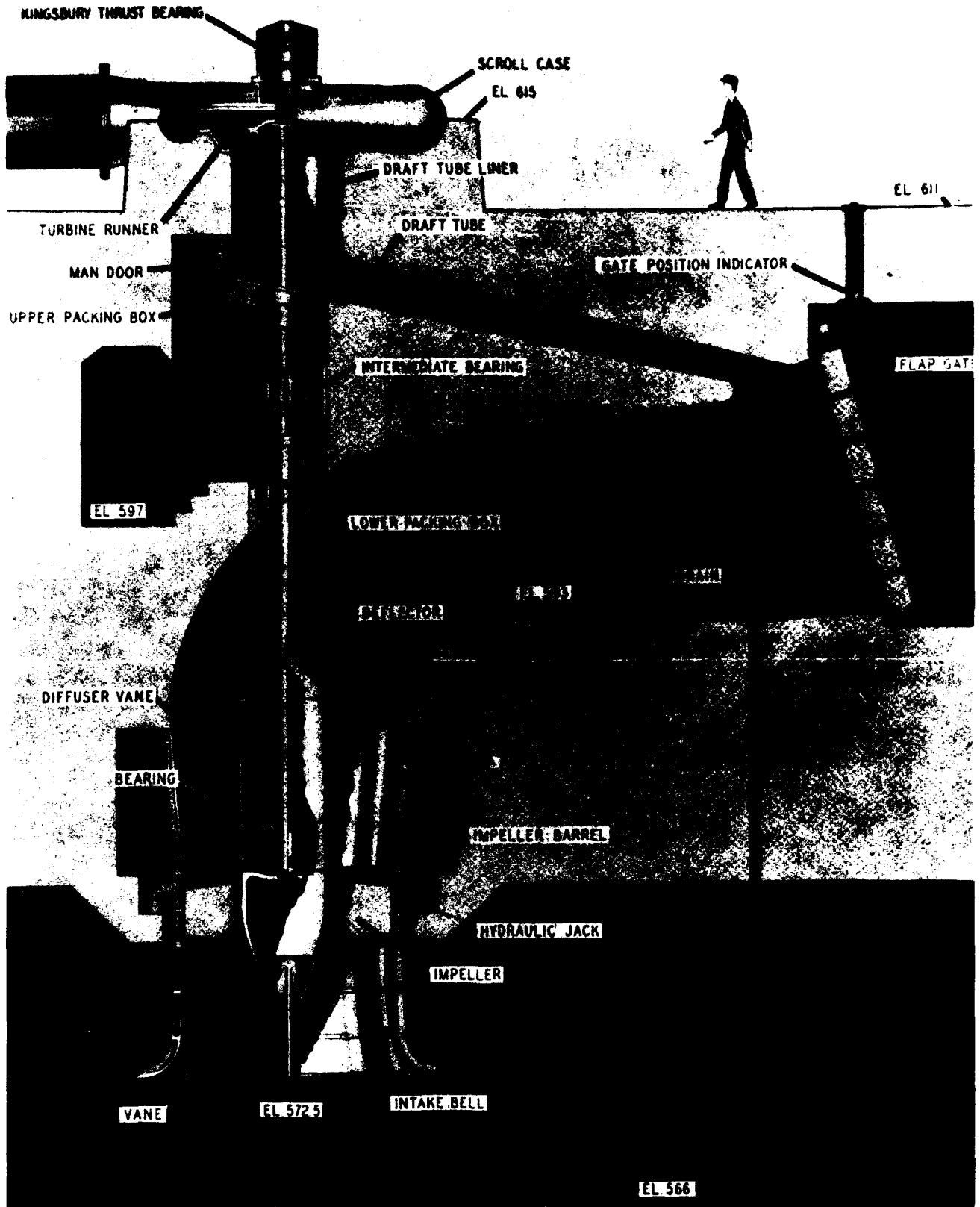

FISHWAY STRUCTURES at Dams and Natural Obstructions

T
The Dalles Dam - Fish Lock
Corps of Engineers, Portland District

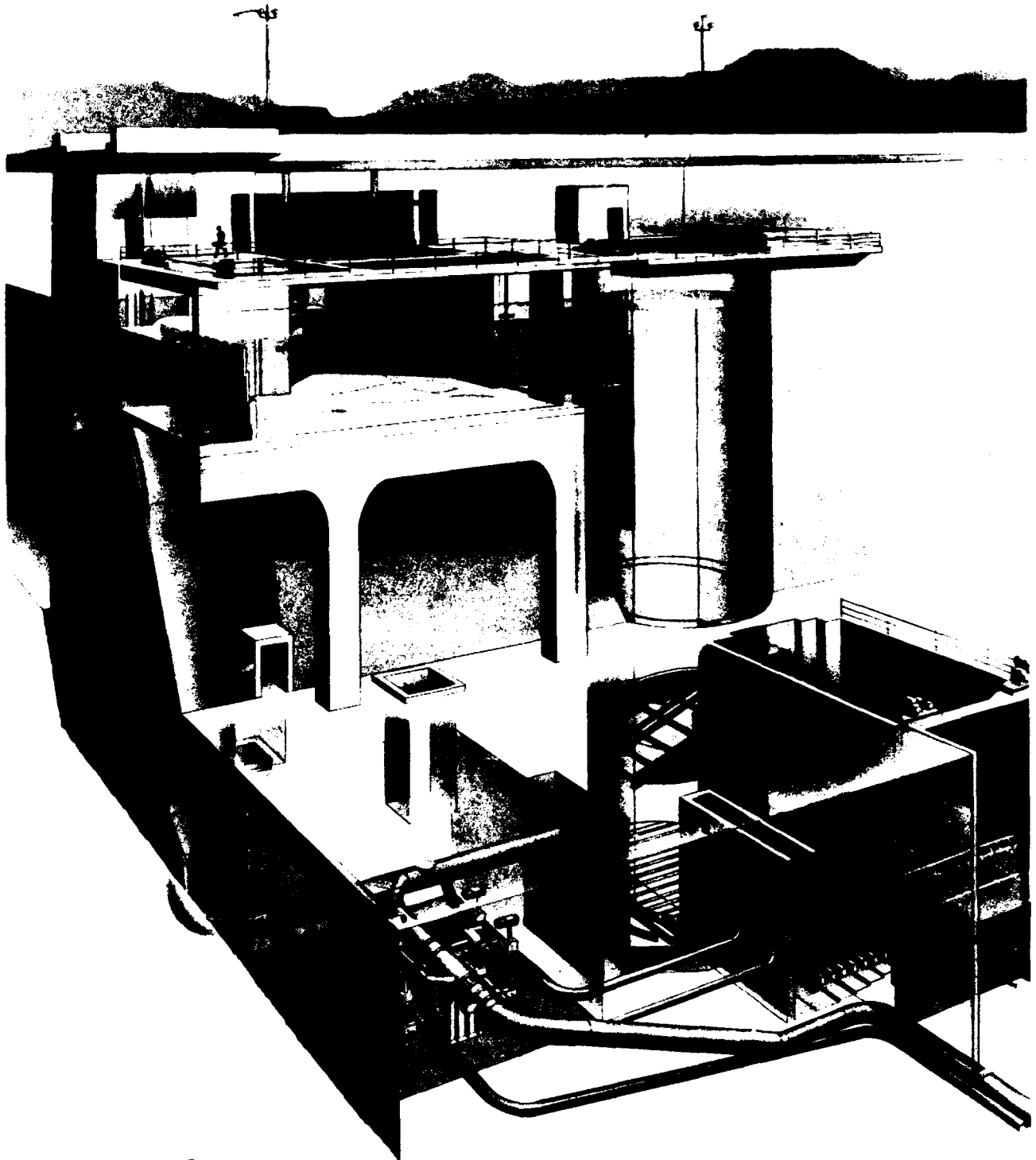

THE DALLES DAM
COLUMBIA RIVER
FISHLOCK
CORPS OF ENGINEERS, U.S. ARMY
PORTLAND DISTRICT

ERIC GUSTAVUS MICHELSON 1957

FISHWAY STRUCTURES at Dams and Natural Obstructions

U

McNary Dam - Washington Shore Fish Ladder and Fish Lock

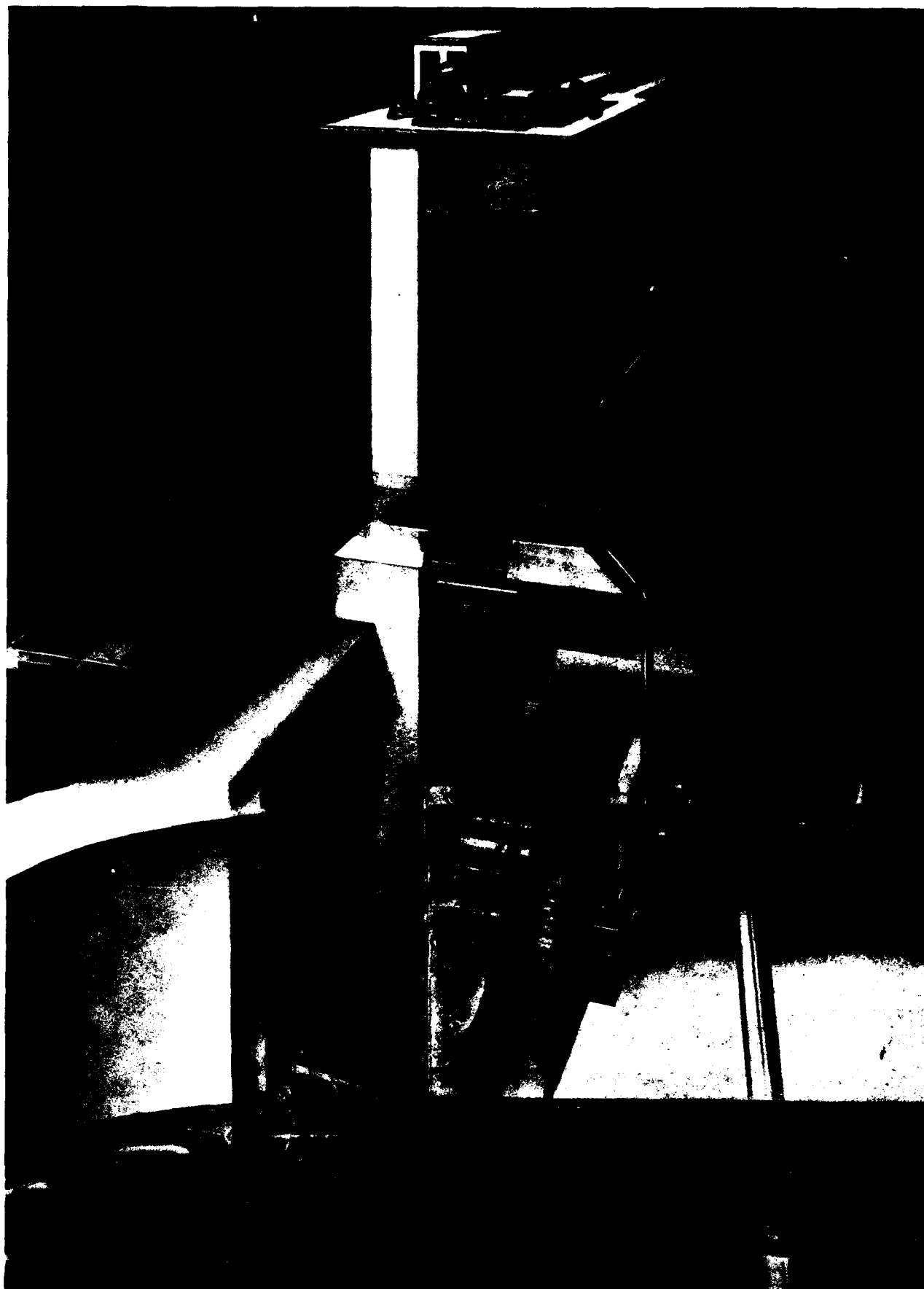

Corps of Engineers

FISHWAY STRUCTURES at Dams and Natural Obstructions

V

The Dalles Dam - Powerhouse Fish Facility

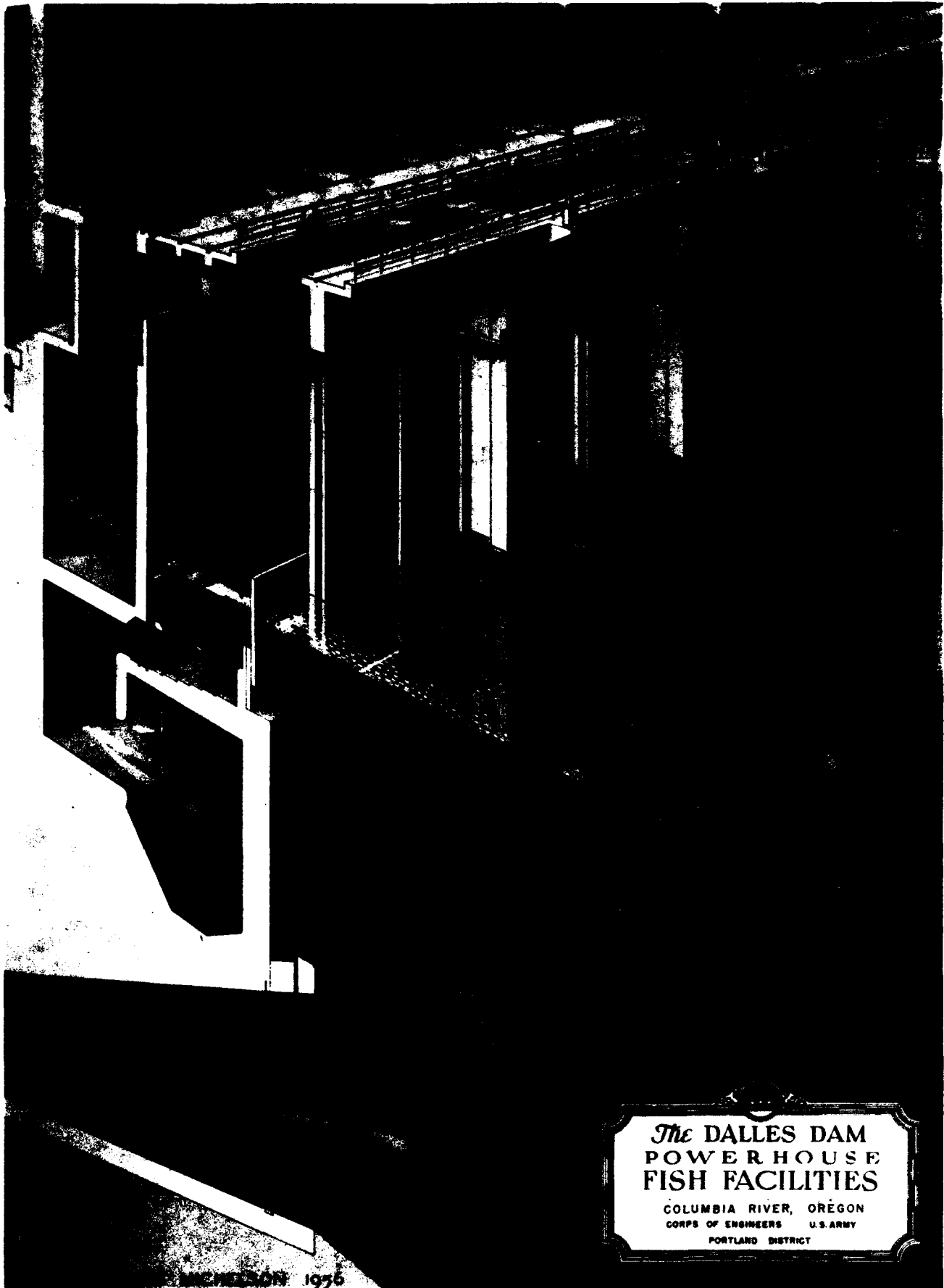

*The DALLES DAM
POWERHOUSE
FISH FACILITIES*
COLUMBIA RIVER, OREGON
CORPS OF ENGINEERS U.S. ARMY
PORTLAND DISTRICT

REYNOLDS 1976

Corps of Engineers, Portland District

FISHWAY STRUCTURES at Dams and Natural Obstructions

W
McNary Dam Powerhouse

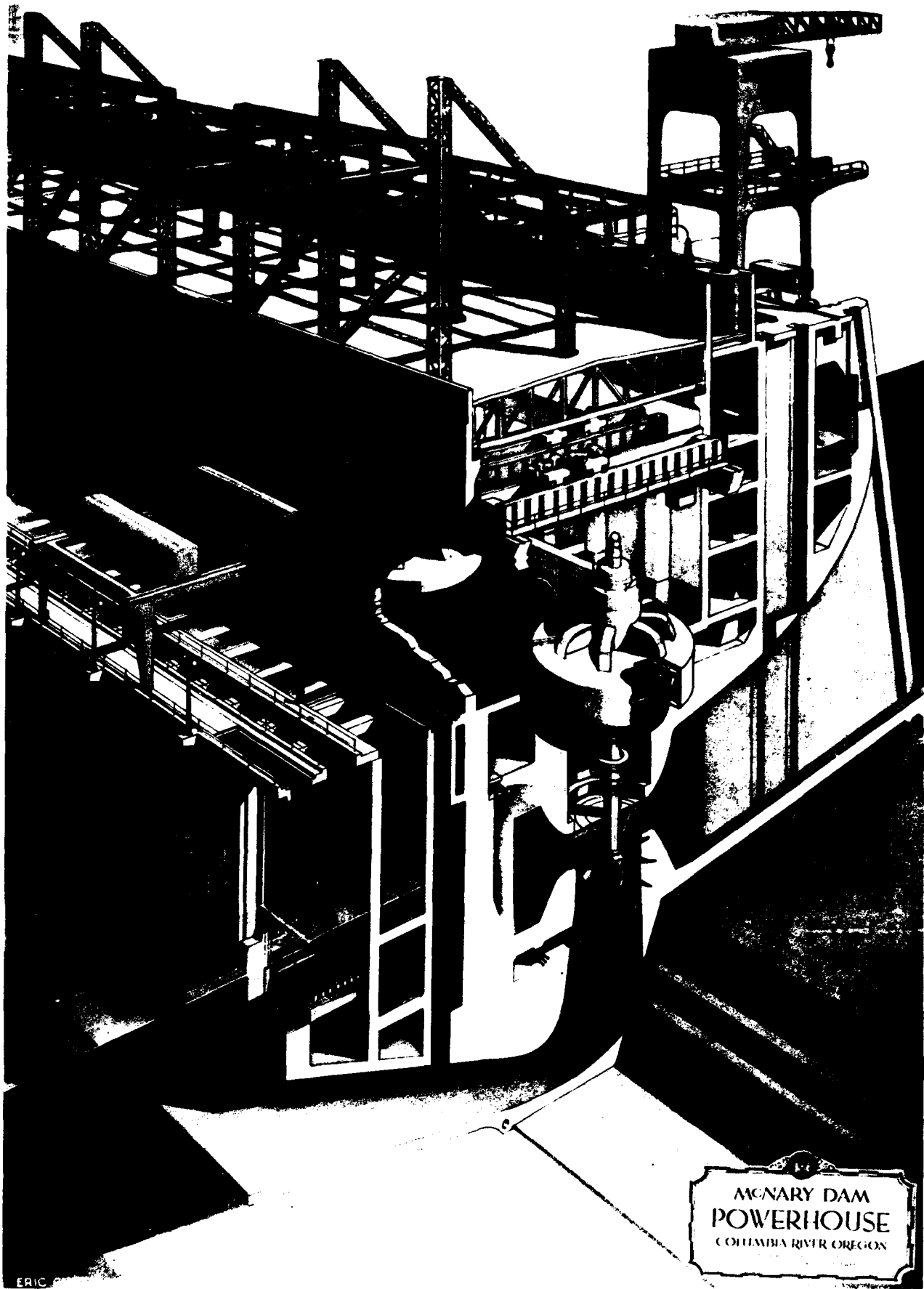

Corps of Engineers, North Pacific Division

X
Slotted Fishway (Wooden Baffles)
Queen Charlotte Islands, British Columbia
Canada Department of Fisheries



FISHWAY STRUCTURES at Dams and Natural Obstructions

Y

Prosser Dam Fishways
Washington Department of Fisheries



Z
McNary Dam Fishways Showing Undesirable Surge
Corps of Engineers, Walla District



FISHWAY STRUCTURES at Dams and Natural Obstructions

AA
Hell's Gate Fishways, Fraser River
International Pacific Salmon Fisheries Commission



FISHWAY STRUCTURES at Dams and Natural Obstructions

BB
Deschutes Fishway
Washington Department of Fisheries

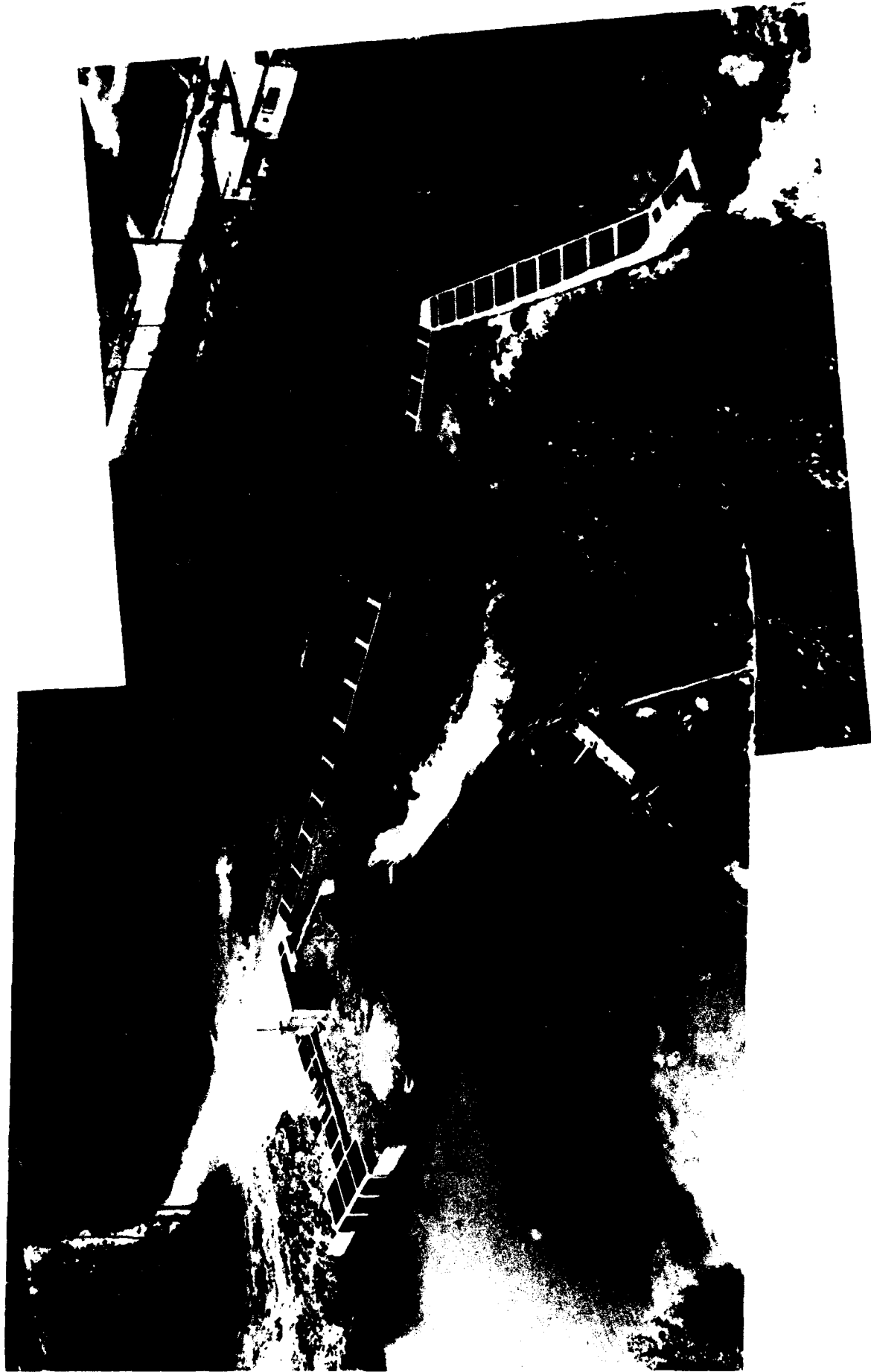

FISHWAY STRUCTURES at Dams and Natural Obstructions

**CC
Salmon Jumping Over Weir**

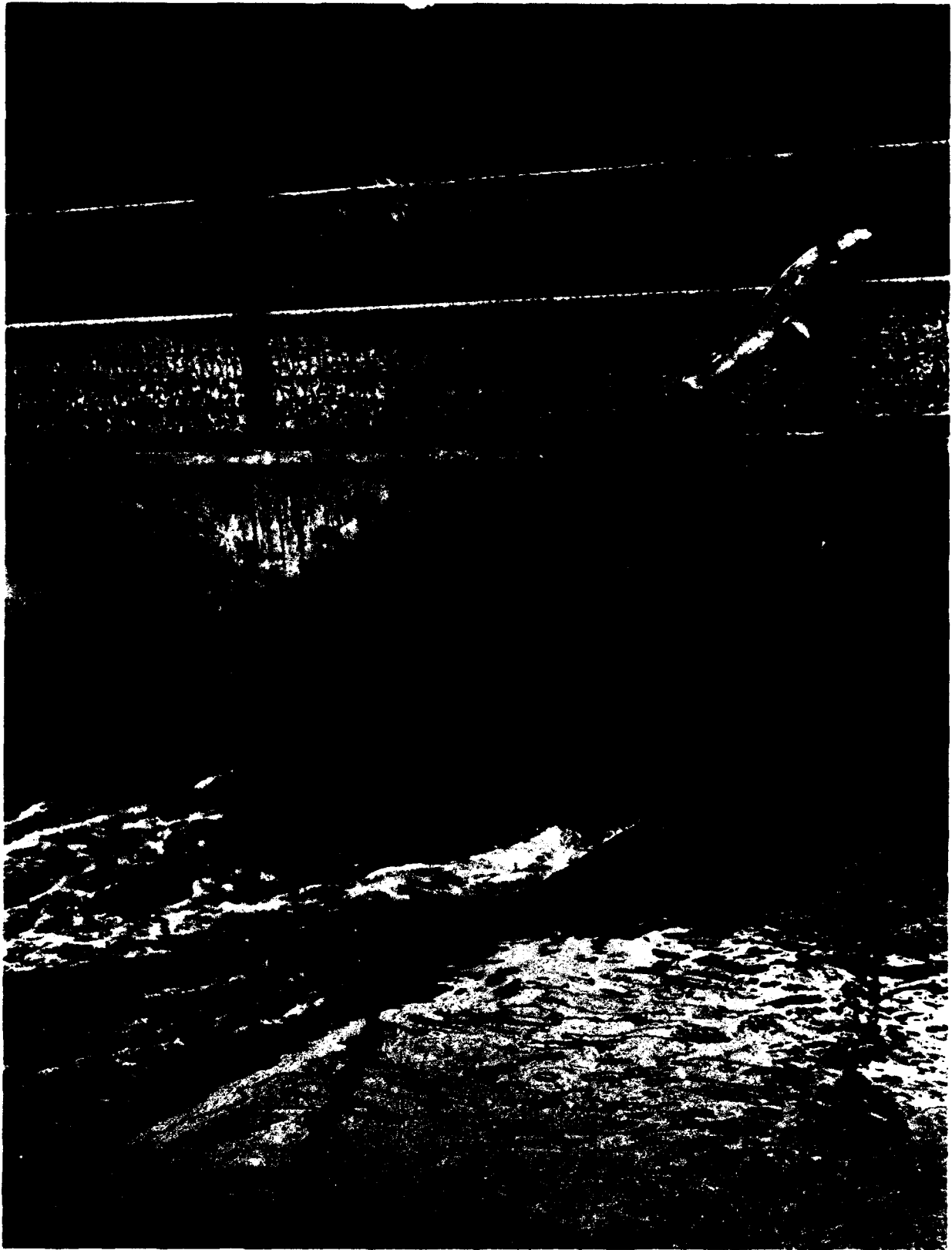

FISHWAY STRUCTURES at Dams and Natural Obstructions

DD
Bonneville Hydraulics Laboratory, McNary Spillway
Corps of Engineers

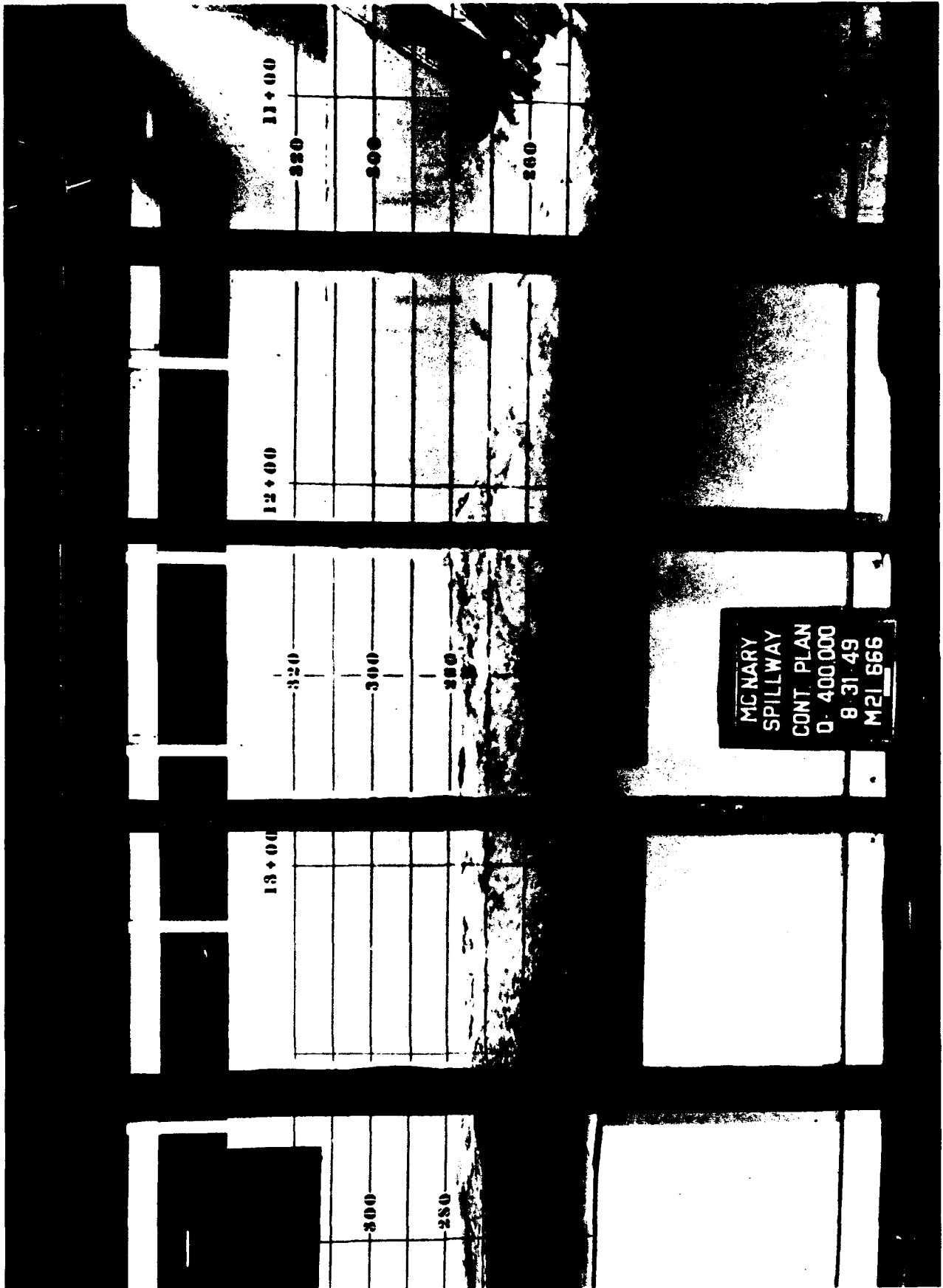

FISHWAY STRUCTURES at Dams and Natural Obstructions

EE Fish Ladder, Plan View Head Difference Regulating Section Corps of Engineers, Portland District

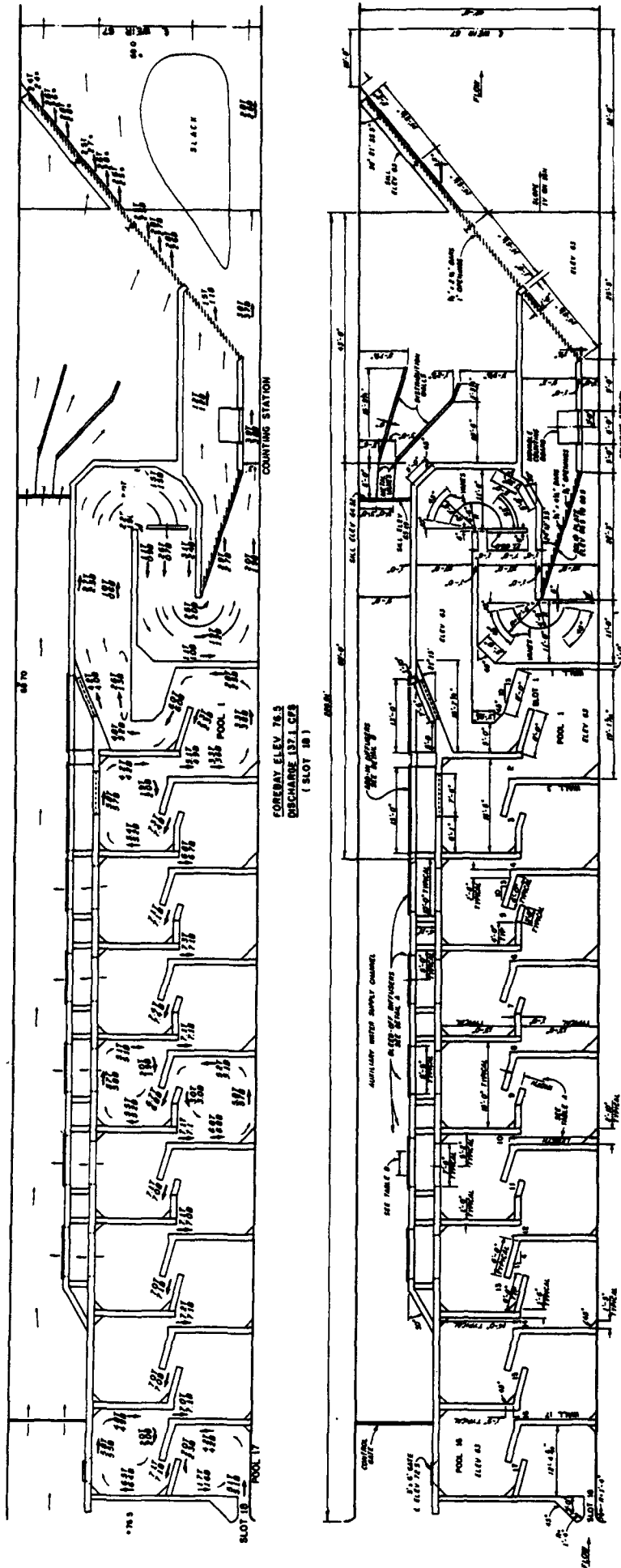

TABLE A

NO.	WATER SURFACE ELEV.	WATER SURFACE AREA	WATER SURFACE PERIMETER
1	75.75	1000	1000
2	75.50	1000	1000
3	75.25	1000	1000
4	75.00	1000	1000
5	74.75	1000	1000
6	74.50	1000	1000
7	74.25	1000	1000
8	74.00	1000	1000
9	73.75	1000	1000
10	73.50	1000	1000
11	73.25	1000	1000
12	73.00	1000	1000
13	72.75	1000	1000
14	72.50	1000	1000
15	72.25	1000	1000
16	72.00	1000	1000
17	71.75	1000	1000
18	71.50	1000	1000
19	71.25	1000	1000
20	71.00	1000	1000

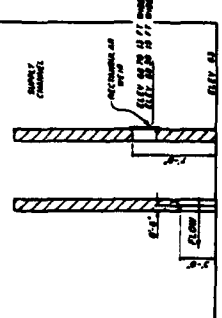
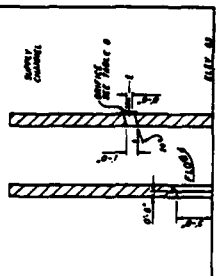

TABLE B

NO.	WATER SURFACE ELEV.	WATER SURFACE AREA	WATER SURFACE PERIMETER
1	75.75	1000	1000
2	75.50	1000	1000
3	75.25	1000	1000
4	75.00	1000	1000
5	74.75	1000	1000
6	74.50	1000	1000
7	74.25	1000	1000
8	74.00	1000	1000
9	73.75	1000	1000
10	73.50	1000	1000
11	73.25	1000	1000
12	73.00	1000	1000
13	72.75	1000	1000
14	72.50	1000	1000
15	72.25	1000	1000
16	72.00	1000	1000
17	71.75	1000	1000
18	71.50	1000	1000
19	71.25	1000	1000
20	71.00	1000	1000



FISHWAY STRUCTURES at Dams and Natural Obstructions

FF

Power Plant with a Canal and Power Plant at Dam Face

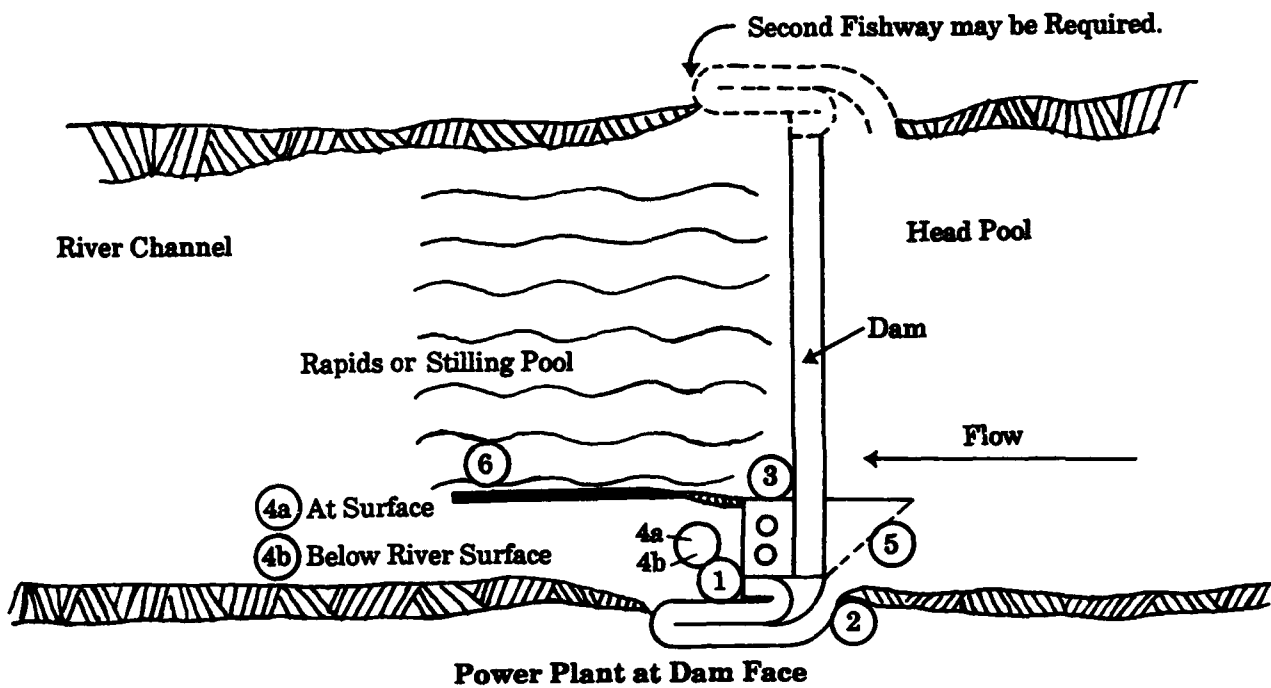
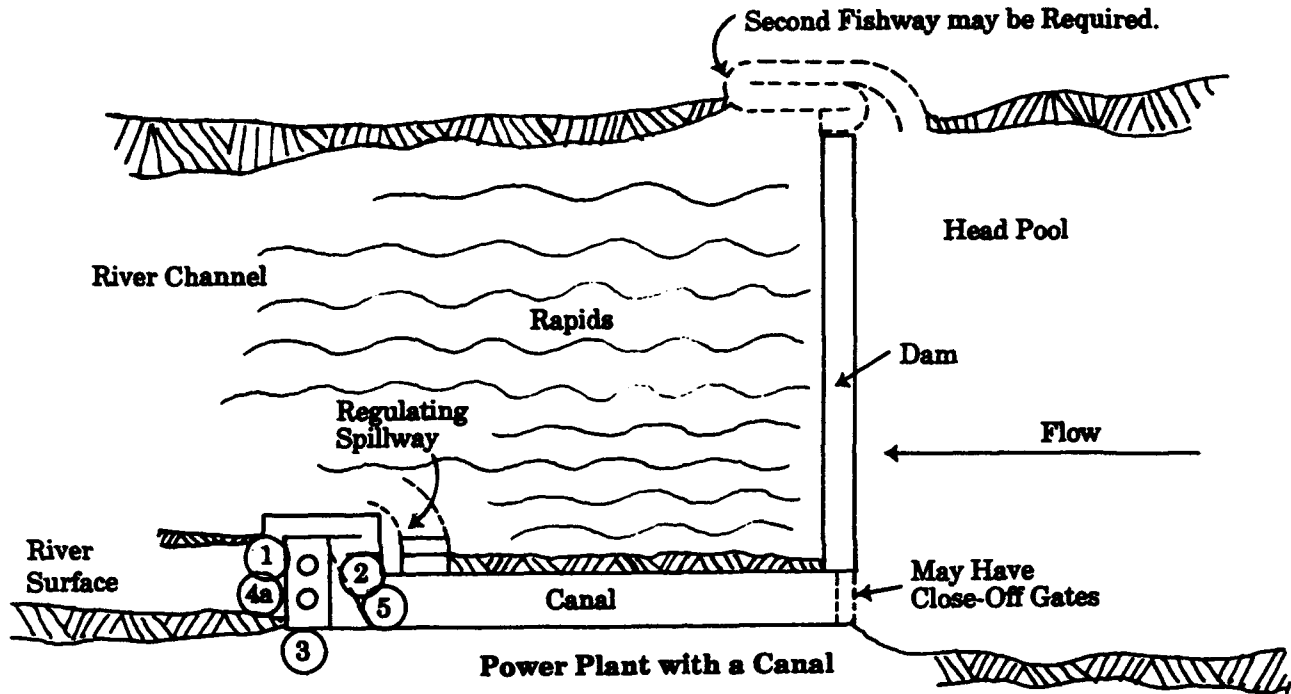

Legend

- | | |
|---------------------------------------|-----------------|
| ① Fishway Entrance | ⑤ Screen |
| ② Fishway Exit | ⑥ Training Wall |
| ③ Powerhouse | |
| ④a Tailrace Level at River Surface | |
| ④b Tailrace Level Below River Surface | |

FISHWAY STRUCTURES at Dams and Natural Obstructions

References Reviewed

1. Elling, Carl H., "Further experiments in fishway capacity, 1957." U.S. Fish and Wildlife, Special Scientific Report - Fisheries No. 340. Washington, D.C. May, 1960.
2. Antonnikov, A.F., "Hydroelectric construction and the problem of fish passage facilities." Hydroelectric Construction, No. 3:26-29. 1964. Translated by Ole A. Mathisen, Fisheries Research Institute, University of Washington, College of Fisheries, Circular No. 225. Seattle. December, 1964.
3. Bell, Milo C., "Experimental work on fishways - model and prototype." Unpublished. International Pacific Salmon Fisheries Commission, New Westminster, B.C. January, 1949. (Also 1946).
4. Eicher, George J., "Problems in fish passage at true reservoirs." Unpublished report. Portland General Electric Company, Portland, Oregon. 1960.
5. Francis, Francis, "Reports on salmon ladders with original drawings, plans and sections." Horace Cox, London. 1870.
6. Harry, A., "The fishways in the dams and waterworks in Switzerland." Swiss Wasserwirtschafts-Verbandes No. 5. Verlag Rascher V Co., Zurich and Leipzig. 1917. (Translated by W.M. Chapman.)
7. Collins, Gerald B., "Proposed research on fishway problems." Unpublished. Submitted to the U.S. Army Corps of Engineers by the Fish and Wildlife Service. 1951.
8. Johnson, Donald R., and Henry T. Heg, "Summary of reports of fish counts at Zosel Dam. Okanogan River, 1952." Unpublished. Washington Department of Fisheries, Olympia, Washington. 1952.
9. Gauley, Joseph R., "Effect of water velocity on passage of salmonids in a transportation channel." U.S. Fish and Wildlife Service, Fishery Bulletin, 66(1):59-63. January, 1967.
10. Lethlean, N.G., "An investigation into the design and performance of electric fish-screens and an electric fish-counter." Royal Society of Edinburgh, Transaction, 62, Part II(13):479-526. 1951-1953.
11. Bell, Milo C., "Improvements to existing dam at Lewiston, Idaho." Unpublished report. Seattle, Washington. May, 1948.
12. Hassard, M.A.I., "Two fish passes on River Shannon." Institution of Civil Engineers of Ireland. Dublin. 1952.
13. Clay, C.H., "Design of fishways and other fish facilities." Canada Department of Fisheries. Ottawa, Canada. January, 1961.
14. Fulton, Leonard A., Harold A. Gangmark, and Scott H. Bair, "Trial of devil-type fish ladder on Pacific salmon." U.S. Fish and Wildlife Service, Special Scientific Report - Fisheries, No. 99. Washington, D.C. May, 1953.
15. Holmes, Harlan B., and Milo C. Bell, "A study of the upstream passage of anadromous fish at Willamette Falls, with recommendations for improvements in fish-passage facilities." Final report (unpublished) to Oregon Fish Commission. Portland. January, 1960.
16. Furuskog, Valter, "A new fishladder." Swedish Fishery Magazine No. 11:236-239. 1945. (Translated from Swedish by Otto E. Lunn.)
17. U.S. Army Corps of Engineers, North Pacific Hydraulic Laboratory Division, "Fish ladders for John Day Dam, Columbia River, Oregon and Washington: hydraulic model investigations." Technical Report No. 103-1. Bonneville, Oregon. December, 1968.
18. Calderwood, W.J., "Hydro-electricity and salmon fisheries." Transactions of the American Fisheries Society, 58:154-160. 1928.
19. Institution of Civil Engineers, Institution Research Committee, "Report for the committee on fish-passes." London. 1942.
20. U.S. Bureau of Commercial Fisheries, Biological laboratory, "Progress report No. 154 for January through March 1969." Research on fishway problems conducted at the Fisheries-Engineering Research Laboratory at Bonneville Dam under Contract No. DA 026-25142 with the U.S. Fish and Wildlife Service. Unpublished report by C.R. Weaver. Seattle, Washington. 1969.
21. Collins, Gerald B., and Carl H. Elling, "Fishway research at the Fisheries-Engineering Research Laboratory." U.S. Fish and Wildlife Service, Bureau of Commercial Fisheries, Circular 98. 1961.
22. Ziemer, P.E., "Steeppass fishway development." Alaska Department of Fish and Game, Informational Leaflet No. 12. April, 1962.
23. Kipper, Z.M., and I.V. Mileiko, "Fishways in hydro developments of the USSR." Rybnoe Khozyaistvo, Moscow. 1962. Translated by A. Wald, Israel Program for Scientific Translations, Ltd. U.S. Department of Commerce, Clearinghouse for Federal Scientific and Technical Information, Springfield, Virginia. 1967.
24. McGrath, C.J., "Inland fisheries and the engineer." Transactions of the Institution of Ireland, 82:51-79. 1956.
25. U.S. Army Corps of Engineers, North Pacific Division, "Progress report on fisheries-engineering research program," pp. 76-90A, contributed by U.S. Bureau of Commercial Fisheries, "Research on Fishway Problems." July, 1960.
26. Leman, Bernie, and G.J. Paulik, "Spill-pattern manipulation to guide migrant salmon upstream." Transactions of the American Fisheries Society, 95(4):397-407. October, 1966.
27. Canada Department of Fisheries, "Skutz Falls fishways." Instructions to tenderers, form of tender, general conditions, specifications and plans. Unpublished. Vancouver, B.C. May, 1955.

FISHWAY STRUCTURES at Dams and Natural Obstructions

References Reviewed (Continued)

28. Fisk, Leonard O., "Experiments with a vertical baffle fishway." *California Fish and Game*, 45(2):111-122. April, 1959.
29. Vande Sande, Ted, "Fishways." In "Inland Fisheries Management," edited by Alex Calhoun, pp. 153-156. California Department of Fish and Game, Sacramento. 1966.
30. International Pacific Salmon Fisheries Commission, "Hydraulic characteristics of the 20-ft. wide twin-jet vertical slot fishway." New Westminster, B.C. 1948.
31. McLeod, A.M., and Nemenyi, Paul, "An investigation of fishways." University of Iowa Studies in Engineering, Bulletin 24. Conducted for the Iowa State Conservation Commission by the Iowa Institute of Hydraulic Research. Iowa City. 1939-40.
32. Talbot, G.B., "A biological study of the effectiveness of the Hell's Gate fishways." International Pacific Salmon Fisheries Commission, Bulletin III, Part 1:7-80. 1950.
33. Collins, Gerald B., "A fishway that shad ascend." U.S. Fish and Wildlife Service, Special Scientific Report-Fisheries, No. 65. Washington, D.C. July, 1951.
34. Murphy, Anthony M., and James C.I. Dodge, "The hydraulic fish lift at Leixlip." *Transactions of the Institution of Civil Engineers of Ireland*, 77(3):61-88. 1951.
35. Lander, Robert H., "The problem of fishway capacity." U.S. Fish and Wildlife Service, Special Scientific Report-Fisheries, No. 301. Washington, D.C. May, 1959.
36. Wayne, Warner, W., "Fish handling facilities for Baker River hydroelectric project." Presented at annual convention American Society of Civil Engineers. Unpublished. October, 1960.
37. Cobb, J.N., "An experiment in lifting salmon over high dams." *Journal of Electricity*, 54(1):50-53. January, 1925.
38. Nemenyi, Paul, "An annotated bibliography of fishways." University of Iowa, Studies in Engineering, Bulletin 23. Iowa City. 1941.
39. Clay, C.H., "A procedure for installation of fishways at natural obstructions." *The Canadian Fish Culturist*, 17:1-12. September, 1955.
40. Tikhii, M.I., "Hydro-electric installations and the problems of fishery on the Lower Dniepr." U.S.S.R. Bureau of Applied Ichthyology Bulletin, 9(1):14-17. 1929.
41. Von Gunten, Glenn H., Hugh A. Smith, Jr., and Berton M. Maclean, "Fish passage facilities at McNary Dam." American Society of Civil Engineers, *Journal of the Power Division*, 82, No. PO1, (Proceedings paper No. 895.) February, 1956.
42. North of Scotland Hydro-Electric Board and Scottish Home Department, Salmon Research Committee, Pass Investigation Sub-Committee, "The passage of smolts and kelts through fish passes," by James Gray, et al. London. H.M.S. Office. 1957.
43. "The Tummel-Garry scheme of the North of Scotland Hydro-Electric Board." *Engineering*, 170(4427):425-429; (4428):460-462; (4429):493-497; (4430):521-529. December, 1950.
44. Eicher, George J., "Round Butte Dam fish-handling costs 2.5% of total project outlay." *Electrical World*, 161(6):36-39. February, 1964.
45. Washington Department of Fisheries, "Development of the Deschutes River in Thurston County, Washington as a major salmon producing river." Unpublished. Olympia. February, 1952.
46. Sakowicz, Stanislaw, and Stanislaw Zarnecki, "Pool-type fishways - biological aspects in their construction." *Roczniki Nauk Rolniczych*, 69, (Series D):5-171. 1954. Translated from Polish. U.S. Department of Commerce, Office of Technical Services, Washington, D.C. 1962.
47. U.S. Army Corps of Engineers, North Pacific Division, "Progress report on fisheries-engineering research program," pp. 43-45. "Fishway Attraction Water Supply Study." Portland, Oregon. July, 1960.
48. Andrew, F.J., and G.H. Geen, "Sockeye and pink salmon investigations at the Seton Creek hydroelectric installation." International Pacific Salmon Fisheries Commission, Progress Report. New Westminster, B.C. 1958.
49. Collins, Gerald B., Joseph R. Gauley, and Carl H. Elling, "Ability of salmonids to ascend high fishways." *Transactions of the American Fisheries Society*, 91(1):1-7. January, 1962.
50. Pacific Salmon Inter-Agency Council, Technical Committee, "Downstream migrant passage problems caused by dams." Report No. 5. Unpublished. October, 1967.
51. Edinger, John E., and John C. Geyer, "Heat exchange in the environment." (Cooling Water Studies No. 2.) Prepared for Edison Electric Institute Research Project No. 49, under Contract PG 49.2072 between the Institute of Cooperative Research of the John Hopkins University and the Edison Electric Institute, Baltimore. June, 1965.
52. Regenthal, A.F., and W.H. Rees, "The passage of fish through Mud Mountain Dam, 1957." Unpublished. Washington State Department of Fisheries. Olympia. 1957.
53. Westley, Ronald E., "Limnological study of Merwin, Upper Baker, and Lower Baker reservoirs." Washington State Department of Fisheries. Olympia. June, 1966.

FISHWAY STRUCTURES at Dams and Natural Obstructions

References Reviewed (Continued)

54. Coche, Andre' G., "Production of juvenile steelhead trout in a freshwater impoundment." *Ecological Monographs*, 37(3):201-228. Summer, 1967.
55. Rees, William H., "The vertical and horizontal distribution of seaward migrant salmon in the forebay of Baker Dam." *Washington State Department of Fisheries, Fisheries Research Papers*, 2(1):5-17. June, 1957.
56. Burner, C.J., "Vertical distribution of downstream migrating chinook salmon fingerlings in the Bonneville forebay, with a note upon the rate of migration." Unpublished memorandum to J.T. Barnaby. U.S. Fish and Wildlife Service, Washington, D.C. December 16, 1949.
57. Reimers, Norman, John A. Maciolek, and Edwin P. Pister, "Limnological study of the lakes in Convict Creek Basin, Mono County, California." U.S. Fish and Wildlife Service, *Fishery Bulletin*, 103(56). Washington, D.C. 1955.
58. Engstrom-Heg, Robert, "Diet and growth of juvenile salmon in an estuarial impoundment." *Washington State Department of Fisheries, Fisheries Research Papers*, 3(1):5-26. August, 1968.
59. Ruggles, C.P., "Juvenile sockeye studies in Owikeno Lake, British Columbia." *The Canadian Fish Culturist*, 36:3-21. December, 1965.
60. Hamilton, J.A.R., L.O. Rothfus, M.W. Erho, and J.D. Remington, "Use of a hydroelectric reservoir for the rearing of coho salmon (*Oncorhynchus kisutch*)." *Washington State Department of Fisheries, Research Bulletin* 9. Olympia. 1970.
61. Trefethen, Parker S., "Effect of impoundments on migration of fish." In his "Fish-Passage Research, Review of Progress, 1961-1966." U.S. Bureau of Commercial Fisheries, Circular 254:3-5. Seattle, Washington. October, 1968.
62. Johnson, Ray C., "The effect of artificial circulation on production of a thermally stratified lake." *Washington State Department of Fisheries, Fisheries Research papers*, 2(4):5-15. December, 1966.
63. Westley, Ronald E., and C. Lynn Goodwin, "Limnological study of Mayfield Reservoir: summary report." *Washington State Department of Fisheries, Olympia*. May, 1967.
64. Klein, W.D., and L.M. Finnell, "Comparative study of coho salmon introductions in Parvin Lake and Granby Reservoir." *The Progressive Fish-Culturist*, 31(2):99-108. April, 1969.
65. Pyefinch, K.A., and D.H. Mills, "Observations on the movements of Atlantic salmon (*salmo salar* L.) in the River Conon and the River Meig, Ross-shire. I." *Scotland Department of Agriculture and Fisheries, Freshwater and Salmon Fisheries Research*, No. 31. 1963.
66. Merrell, Theodore R., and Melvin D. Collins, "An investigation of adult chinook salmon mortality in the vicinity of "Bonneville Dam, 1954 and 1955, on the Columbia River." Unpublished final report for the Oregon Fish Commission under Contract No. DA-35-026-eng-20892. Funds supplied through the U.S. Fish and Wildlife Service. Portland, Oregon. August, 1960.
67. McKinley, W.R., and R.D. Webb, "A proposed correction of migratory fish problems at box culverts." *Washington Department of Fisheries, Fisheries Research Papers*, 1(4):33-45. March, 1956.
68. Thompson, W.F., "Report on a temporary passage around the obstruction at Hell's Gate Canyon, Fraser River." *International Pacific Salmon Fisheries Commission*. Unpublished report. New Westminster, B.C. March 21, 1942.
69. Canada Department of Fisheries and International Pacific Salmon Fisheries Commission, "A report on the fish facilities and fisheries problems related to the Fraser and Thompson River dam site investigation." Prepared in collaboration with the British Columbia Department of Fisheries and British Columbia Game Commission, Vancouver, B.C. November, 1955.
70. Gilhousen, Philip, "Migratory behavior of adult Fraser River sockeye." *International Pacific Salmon Fisheries Commission, Progress Report No. 8*. New Westminster, B.C. 1960.
71. Clay, C.H., "Report on a tour of fish facilities in the Republic of Ireland, September 27-29, 1962." *Canada Department of Fisheries, Fish Culture Development Branch, Pacific Area, Vancouver, B.C.* 1962.
72. Haas, James B., Burton E. Carnegie, and Charles Junge, "Fish passage problems at lower Columbia River dams in 1968." Part II of report to Oregon Fish Commission, Contract No. DACW 68-68-C-0081. Portland, Oregon. April, 1969.
73. Clay, C.H., "Report on an inspection of fish facilities in the Netherlands." *Canada Department of Fisheries, Fish Culture Development Branch, Pacific Area, Vancouver, B.C.* April, 1963.
74. Idler, D.R., and W.A. Clemens, "The energy expenditures of Fraser River sockeye salmon during the spawning migration to Chilko and Stuart lakes." *International Pacific Salmon Fisheries Commission, Progress Report No. 6*. New Westminster, B.C. 1959.
75. Collins, Gerald B., Joseph R. Gauley, and Carl H. Elling, "Ability of salmonids to ascend high fishways." *Transactions of the American Fisheries Society*, 91(1):1-7. January, 1962.
76. Hayes, F.R., "Artificial freshets and other factors controlling the ascent and population of Atlantic salmon in the LaHave River, Nova Scotia." *Fisheries Research Board of Canada, Bulletin* 99. 1953.

FISHWAY STRUCTURES at Dams and Natural Obstructions

References Reviewed (Continued)

77. "Passage of fish over Bonneville and McNary Dams 1954." Annual Report for 1954. U.S. Army Corps of Engineers, Portland District, Portland, Oregon. 1954.
78. Dunstan, William, "Variations in the depot fats of Columbia River sockeye." In "Progress Report - Puget Sound Stream Studies" by W.E. Bostick, W.A. Dunstan and W.H. Rees. Unpublished. Washington Department of Fisheries, Olympia. 1956.
79. Johnson, James H., "Vertical and horizontal fish distribution observed with sonic gear, lower navigation channel - Bonneville Dam." U.S. Fish and Wildlife Service, Pacific Salmon Investigations, Technical Progress Report No. 13 (Preliminary report...not for public release.) Seattle, Washington. March, 1956.
80. Collins, Gerald B., Carl H. Elling, Joseph R. Gauley, and Clark S. Thompson, "Effect of fishway slope on performance and biochemistry of salmonids." U.S. Fish and Wildlife Service, Fishery Bulletin, 63(1):221-253. Washington, D.C. 1963.
81. Powers, Edwin B., "Chemical factors affecting the migratory movements of the Pacific salmon." American Association for the Advancement of Science, Publication No. 8:72-85. 1939.
82. Junge, Charles, "Operational studies at dams on the Lower Columbia River with a brief analysis of adequacy of new spilling techniques at Ice Harbor Dam." Part I of report to Oregon Fish Commission, Contract No. DACW 68-68-C-0081. Portland, Oregon. April, 1969.
83. Sams, Roy E., and Kelly R. Conover, "Water quality and migration of fall salmon in the lower Willamette River." Unpublished final report. Oregon Fish Commission, Portland. May, 1969.
84. Van Hyning, Jack Mattson, "Factors affecting the abundance of fall chinook salmon in the Columbia River." Ph.D. thesis. Oregon State University, Corvallis. March, 1968.
85. Monan, Gerald E., Jim R. Smith, Kenneth L. Liscom, and James H. Johnson, "Evaluation of upstream passage of adult salmonids through the navigation lock at Bonneville Dam during the summer of 1969." Final report. U.S. Bureau of Commercial Fisheries, Biological Laboratory, Seattle, Washington. January, 1970.
86. Weaver, Charles R., "Influence of water velocity upon orientation and performance of adult migrating salmonids." U.S. Fish and Wildlife Service, Fishery Bulletin, 63(1):97-121. 1963.
87. Trefethen, Parker S., "Passage of migrant fish at dams." In his "Fish-Passage Research, Review of Progress, 1961-1966." U.S. Bureau of Commercial Fisheries, Circular No. 254:10-14. Seattle, Washington. October, 1968.
88. MacKinnon, D., and J.R. Brett, "Fluctuations in the hourly rate of migration of adult coho and spring salmon up the Stamp Falls fish ladder." Fisheries Research Board of Canada, Progress Report of the Pacific Coast Stations, No. 95:53-55. July, 1953.
89. Davidson, F.A., E. Vaughan, and S.J. Hutchinson, "Factors influencing the upstream migration of the pink salmon (*Oncorhynchus gorbuscha*)." Ecology, 24(2):149-168. April, 1943.
90. Long, Clifford W., "Passage of salmonoids through a darkened fishway." U.S. Fish and Wildlife Service, Special Scientific Report-Fisheries No. 300. Washington, D.C. May, 1959.
91. U.S. Army Corps of Engineers, North Pacific Division, "Progress Report on Fisheries-Engineering Research Program." pp. 42-48, "Powerhouse system attraction and transportation flows - Bonneville Dam." Portland. November, 1956. Also pp. 127-130. July, 1960.
92. Johnson, D., I. Donaldson, and K. Weber, "Bonneville Dam powerhouse fish collection system observations, fall 1948." Unpublished. Sponsored by Fish and Wildlife Service, U.S. Army Corps of Engineers, Oregon Fish Commission, and Washington State Department of Fisheries. April 1949.
93. "A plan for the protection and maintenance of salmon and steelhead in the American River, California, together with recommendations for action." U.S. Fish and Wildlife Service, and California Department of Fish and Game. Unpublished. 1953.
94. U.S. Army Corps of Engineers, North Pacific Division, "Progress Report on Fisheries-Engineering Research Program," pp. 56-57, "Buoyant submerged orifice research." Portland. November, 1956. Also pp. 136-137. July, 1960.
95. "Information bulletin fish passage facilities Bonneville Dam." U.S. Army Corps of Engineers, Portland District, Report No. 66-1. April, 1958.
96. U.S. Army Corps of Engineers, North Pacific Division, "Progress Report of Fisheries-Engineering Research Program." pp. 67-73, "Submerged orifice research powerhouse fish collection system, Bonneville Dam." November, 1956. Also pp. 131-135. July, 1960.
97. Thompson, Clark S., William Spencer Davis, and Emil Slatick, "Response of migrating adult salmonids to vertical and horizontal rectangular orifices at two depths." U.S. Fish and Wildlife Service, Special Scientific Report-Fisheries, No. 547. Washington, D.C. June, 1967.
98. Slatick, Emil, "Passage of adult salmon and trout through pipes." U.S. Fish and Wildlife Service, Special Scientific Report-Fisheries, No. 592. Washington, D.C. January, 1970.
99. Smoker, William A., "Effects of Minter Creek streamflows on the juvenile production of silver salmon, chum salmon and steelhead trout." Part II of "Preliminary Report on Minter Creek Biological Studies." Unpublished. Washington State Department of Fisheries. Olympia. 1956.

FISHWAY STRUCTURES at Dams and Natural Obstructions

References Reviewed (Continued)

100. Maib, Charles W., and Donald E. Hertzog, "The Nisqually River Basin report." Unpublished. Submitted to the Washington State Department of Fisheries. Olympia. February, 1956.
101. Davidson, F.A., "The effect of floods on the upstream migration of the salmon in the Columbia River." Public Utility District No. 2 of Grant County. March, 1957.
102. Leopold, Luna B., and Thomas Maddock, Jr., "The hydraulic geometry of stream channels and some physiographic implications." U.S. Geological Survey, Professional Paper 252. Washington, D.C. 1953. Reprinted, 1959.
103. Lister, D.B., and C.E. Walker, "The effect of flow control on freshwater survival of chum, coho and chinook salmon in the Big Qualicum River." The Canadian Fish Culturist, 37:3-25. August, 1966.
104. Quistorff, Elmer, "Floating salmon smolt collectors at Baker River dams." Washington State Department of Fisheries, Fisheries Research Papers, 2(4):39-52. December, 1966.
105. Phillips, Robert W., "Effect of unusually low discharge from Pelton regulating reservoir, Deschutes River, on fish and other aquatic organisms." Oregon State Game Commission, Basin Investigations Section, Special Report No. 1. Portland. May, 1969.
106. Ruggles, C.P., "Depth and velocity as a factor in stream rearing and production of juvenile coho salmon." The Canadian Fish Culturist, 38:37-53. October, 1966.
107. Carney, R.E., and R.J. Adkins, "Reactions of young silver salmon in ten velocity combinations." School of Fisheries, Technical Report 23. Unpublished. University of Washington, Seattle. August, 1955.
108. Weaver, Charles R., "Observations on the swimming ability of adult American shad (*Alosa sapidissima*)." Transactions of the American Fisheries Society, 94(4):382-385. October, 1965.
109. Junge, Charles, "Standardization of spill patterns at Ice Harbor Dam." Unpublished report. Oregon Fish Commission, Clackamas. December, 1967.
110. Perkins, L.Z., and P.M. Smith, "Modification of fish ladders, Bonneville Dam, Columbia River, Oregon and Washington." Hydraulic model investigation. U.S. Army, Corps of Engineers, North Pacific Division, Hydraulic Laboratory, Technical Report No. 141.1. Bonneville, Oregon. December, 1973.
111. Katopodis, C., and N. Rajaratnam, "A review and laboratory study of the hydraulics of Denil fishways." Canadian Technical Report of Fisheries & Aquatic Sciences, No. 1134, Western Region, Department of Fisheries and Oceans, Winnipeg, Manitoba. January, 1983.

Chapter 35

Oxygen

Composition of air.

Stream reaeration.

Oxygen sag curve.

Deoxygenation coefficient.

Reaeration coefficient.

Pond reaeration.

Diffusion coefficient.

Absorption coefficient.

Oxygen consumption of fed
and starved sockeye.

Reoxygenation by mechanical means.

Reoxygenation efficiency of stones,
micropore tubes and latex tubes.

Capacity of oxygen cylinders.

Table 1. Use of Oxygen by Fish.

**Table 2. Use of Oxygen by Fish
as Calculated Under River
Migration Conditions.**

**Table 3. Adult Oxygen
Computations (From Tests).**

**Table 4. Oxygen Concentrations
at Various Temperatures in
Freshwater.**

References Reviewed.

OXYGEN

The amount of dissolved oxygen in water is important to the well-being of fish and aquatic food organisms. (See also Chapter 1, "Miscellaneous Information," Chapter 8, "Food Producing Areas," Chapter 11, "Temperature - Effects on Fish," Chapter 12, "Silt and Turbidity," Chapter 17, "Fish Toxicants" and Chapter 19, "Hatcheries.")

In dealing with the transfer of oxygen from the atmosphere (dry air at sea level), the percent of oxygen in relation to other gases is as follows (by volume): oxygen 20.95%, nitrogen 78.09%, argon .93% and carbon dioxide .03%.

The mechanism by which oxygen is transferred from the atmosphere into still water (i.e., rearing ponds, small lakes, etc., without surface movement) is diffusion. In flowing water (exposed to the atmosphere) it comes about, in addition to diffusion, by entrainment combined with turbulence which mixes rich, oxygenated surface waters with less oxygenated waters from depths. The effect of winds, which produce mixing, can be an important factor.

The literature suggests two approaches that can be useful to investigators: the Streeter-Phelps steady state model for stream reaeration and the Phelps method for pond reaeration by diffusion. In using either approach, the amount of oxygen in the incoming water must be known, including the demands for oxygen contained in such water. It also should be stated that the methods shown here are simplified and, for this reason, may result in errors if applied to complicated programs with many demands for oxygen. A single point source with a high oxygen demand may deplete a stretch of water.

The oxygen sag curve, as defined by Streeter-Phelps, is the basic model used.

The total effect of deoxygenation and reaeration can be resolved from the two curves which form the sag curve.

Oxygen Sag Curve

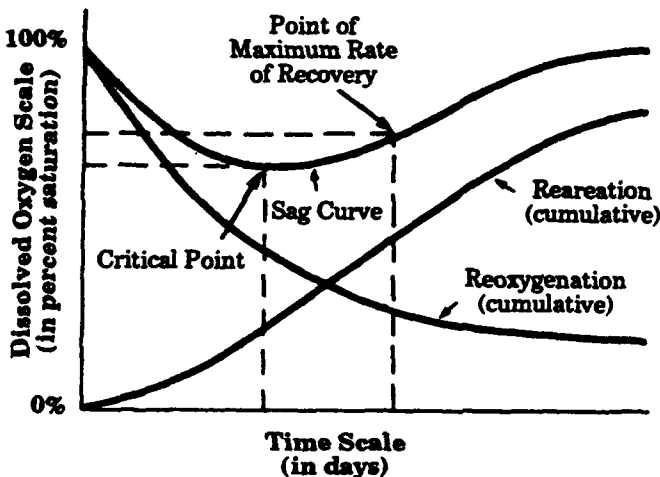

The integrated form of the above curve is as follows:

$$D_t = \frac{k_1 L_a}{k_2 - k_1} \left(10^{-k_1 t} - 10^{-k_2 t} \right) + D_a \times 10^{-k_2 t}$$

where

D_t = oxygen deficit after a period of time

t = time (usually in days)

D_a = initial oxygen deficit

k_1 = deoxygenation coefficient or BOD decay rate coefficient to base 10

k_2 = reaeration coefficient to base 10

L_a = initial BOD

L_a , D_a , and D_t must be in the same unit, such as milliliters per liter, parts per million or pounds per million gallons

Determine k_1 by the following equation:

$$k_1 = -\frac{1}{t} \log \left[\frac{L_b}{L_b + X_t} \right]$$

where

X_t = total oxygen demand in a river section in a period of time

L_b = BOD at exit point

When the measurement of X_t involves observations of BOD at the upstream point (station a) and the downstream point (station b), the following equation can be used if there is no inflow between the stations, but it must be adjusted if there is.

$$k_1 = -\frac{1}{t} \log \left[\frac{L_b}{L_a} \right]$$

Determine k_2 by the following:

$$k_2 = \frac{r_m}{2.3 D_m}$$

where

r_m = amount of reaeration between two points in a stream

$r_m = X_t + (D_a - D_b)$

D_b = dissolved oxygen deficit at the lower point (b) in the stream stretch considered

D_m = mean dissolved oxygen deficiency

$$D_m = \frac{D_a + D_b}{2}$$

An indirect method of calculating k_2 can be determined graphically from the oxygen sag relationship when all terms except k_2 are known.

OXYGEN

For comparison, k_1 and k_2 values are usually reduced to a standardized temperature value (20 C). If coefficient values are collected from field data at a different temperature, they can be adjusted to the standard temperature coefficient value by:

$$k_{1T} = k_{120} \times 1.047^{(T-20)}$$

$$k_{2T} = k_{220} \times 1.047^{(T-20)}$$

where

T = stream temperature (C.)

k_{1T} , k_{2T} = coefficient value at stream temperature

k_{120} , k_{220} = coefficient value at standard temperature

The following problem demonstrates the use of the oxygen sag curve relationship by determining the effect of large numbers of spawning fish in a confined channel and the reaeration of the channel.

Assume a 5,280 foot long spawning channel, 20 feet wide, with a depth of 1.5 feet and a flow of 45 cubic feet per second. The water is at 12.8 C. and its exchange time is 0.4 days. The channel is stocked with adult salmon at the rate of 2,667 fish/1,000 feet of channel.

Assume

$$L_a = 4 \text{ ppm}$$

$$L_b = 2 \text{ ppm}$$

$$D_a = 2 \text{ ppm}$$

$$D_b = 0$$

Demand of adult fish averaging 7 lbs in weight

$$\begin{aligned} X_t &= 2667 \text{ fish}/1000 \text{ ft} \times 7 \text{ lbs}/\text{fish} \times 40 \times 10^{-4} \text{ oz} \\ &\quad \text{O}_2/\text{lb fish}/\text{hr} \times 5280 \text{ ft} \times .4 \text{ day} \times 24 \text{ hr}/\text{day} \\ &= 3785.18 \text{ oz O}_2 \end{aligned}$$

$$X_t \text{ (ppm)} = \frac{3785.18 \text{ oz} \times 1/5280 \text{ ft} \times 1/1.5 \text{ ft} \times 1/20 \text{ ft} \times 1 \text{ cu ft}/10^{-3} \text{ oz}}{1} = 23.90 \text{ ppm}$$

$$k_1 = -\frac{1}{.4} \log \frac{2}{4} = .75$$

$$r_m = 23.90 + 2.0 = 25.90$$

$$D_m = \frac{2+0}{2} = 1$$

$$k_2 = \frac{25.90}{(2.3)(1)} = 11.26$$

With these values computed

$$D_t = .14 \text{ ppm}$$

Therefore, DO leaving channel is $10.6 \text{ (Sat)} - .14 = 10.46$ ppm. To reduce k value to standard temperature

$$k_{120} = \frac{k_{212.8}}{1.047^{(12.8-20)}} = 1.04$$

$$k_{220} = \frac{k_{212.8}}{1.047^{(12.8-20)}} = 15.67$$

Using this short period of time for recovery results in a high value for k_1 and k_2 . A higher value is needed if complete recovery results or is assumed as all activity is compressed to a short time period. Field readings are necessary to determine a particular coefficient for a channel of the shape and slope to be used.

In dealing with static bodies of water, the Phelps method is suggested, as it describes the computation of the reaeration coefficient (R). The first step is the calculation of the oxygen diffusion coefficient for the desired temperature. The diffusion coefficient (a) is determined in relation to the diffusion coefficient at 20 C (a_{20}) by the following formula:

$$a = a_{20} \times 1.1^{(T-20)}$$

where

$$a_{20} = 0.00153$$

T = desired temperature (C)

After the diffusion coefficient is calculated for the desired temperature, the absorption coefficient (K) is then computed as follows:

$$K = \frac{\pi^2}{4L^2} at$$

where

π = (constant)

a = diffusion coefficient

t = time in hours required in mixing

L = depth of the pond (average)

The reaeration or decrease in oxygen deficit per mix (R) may then be determined from the following equation:

$$\log R_o = 1.85 + 0.5 \log K$$

where

R_o = percent reaeration (of saturated value) at zero DO

The percent reaeration of any deficit (R) above zero may then be computed from the following relationship:

$$R = R_o D_A/100$$

OXYGEN

where

D_A = the deficit in percent

By multiplying R by the saturated oxygen value for the given temperature the reaeration in ppm per mix may be obtained. This value may then be multiplied by 8.34 to obtain pounds per million gallons (mil gal) of water per mix. This figure may be used with the volume of the pond to obtain the reaeration in pounds of oxygen per mix for the pond and with the oxygen consumption of the fish to determine the loading factor for the pond.

The following problem demonstrates the use of this approach in determining the carrying capacities of large rearing ponds with minimal incoming flows for replacement of evaporation-seepage losses.

Assume a pond of 4.6 surface acres, averaging 10 feet in depth. The water is at 4.4 C. and the saturation level of dissolved oxygen is 13.0 ppm.

Diffusion coefficient for pond:

$$a_{4.4} = 0.00153 \times 1.1^{(4.4-20)}$$

$$= 3.426 \times 10^{-4}$$

Absorption coefficient for pond, assuming 1-hour mixing time:

$$K = (3.1416)^2 (3.426 \times 10^{-4}) (1 \text{ hr}) / (4 \times 10^2)$$

$$= 8.4533 \times 10^{-6}$$

Reaeration coefficient for pond:

$$\text{Log } R_o = 1.85 + 0.5 \text{ log } 8.4533 \times 10^{-6}$$

$$R_o = 0.2058 \text{ percent saturation per hour (per mix)}$$

Assume that DO is reduced to 5.0 ppm. then at 4.4 C the oxygen deficit (D_A) is:

$$\frac{(13-5)}{13} = 61.54\%$$

$$R = 0.2058 \times .6154$$

$$= 0.1266 \text{ percent saturation per hour (mix)}$$

$$= 13.0 \times 0.001266 = 0.0165 \text{ ppm per hour (mix)}$$

$$= 0.0165 \times 8.34 = 0.1372 \text{ lbs O}_2 \text{ per mil gal per hour (mix)}$$

Water capacity of pond:

$$43,560 \text{ ft}^2/\text{acre} \times 4.6 \text{ acre} \times 10 \text{ feet} \times 7.48 \text{ gal/ft}^3$$

$$= 14,988,812 \text{ gallons}$$

Pond reaeration, assuming one mix per hour (greater mixing accompanies strong winds):

$$14,988 \text{ mil gal} \times 0.1372 \text{ lbs O}_2/\text{mil gal} = 2.0564 \text{ lbs oxygen per hour}$$

Oxygen Consumption

Under normal activity 1 pound of fish uses 24.0×10^{-4} ounces oxygen per hour (10 C.) $2.0564 \times 16/24.0 \times 10^{-4} = 13,709.33 \text{ lbs of fish.}$

To aid the investigator in determining possible oxygen demands by fish under various conditions, the following tables have been prepared. See Chapter 19, "Hatcheries," and Chapter 20, "Rearing Ponds."

*The amount of oxygen used by fish varies widely, depending on the level of activity at constant temperature.

Table 1
Use of Oxygen by Fish
(after Brett and Zala)

	Mean O ₂ consumption		High O ₂ consumption at feeding		Low O ₂ consumption	
	mg/kg/hr	oz/lb/hr	mg/kg/hr	oz/lb/hr	mg/kg/hr	oz/lb/hr
Fed Fish						
Night	170	27×10^{-4}			169	27×10^{-4}
Day	274	44×10^{-4}	375	60×10^{-4}		
Starved Fish						
Night	170	27×10^{-4}			155	25×10^{-4}
Day	297	48×10^{-4}				

(Mean from day 6 through day 22 of test).

Fish used were 29-g sockeye salmon.

OXYGEN

Table 2
Use of Oxygen by Fish as Calculated
Under River Migration Conditions.

Migrating Smolts

Temperature	Minimum Scope		Maximum Scope		Migrating Adults	
	mg/kg/hr	oz/lb/hr	mg/kg/hr	oz/lb/hr	mg/kg/hr	oz/lb/hr
57 F. (14 C.)	370	59x10 ⁻⁴	640	103x10 ⁻⁴	620	99x10 ⁻⁴

From sockeye salmon data.
 Adapted from Reference No. 13.

Table 3
Adult Oxygen Computations
 (From Tests)

Adult oxygen requirements are as follows:

Rest: 1 pound of fish requires
 7.91 x 10⁻⁴ ounces of oxygen per hour.

Normal Activity: 1 pound of fish requires
 24 x 10⁻⁴ ounces of oxygen per hour.

Active Swimming: 1 pound of fish requires
 40 x 10⁻⁴ ounces of oxygen per hour.

Active Feeding: 1 pound of fish requires
 40 x 10⁻⁴ ounces of oxygen per hour.

See Reference No. 12.

OXYGEN

Table 4
Oxygen Concentrations at Various Temperatures
in Freshwater.

Temperature		By weight			By volume		
		mg/l ppm	oz/ft ³	oz/gal	cc/l	ft ³ /ft ³	ft ³ /gal
39	3.9	13.1	.0131	.00175	9.24	.00924	.00124
40	4.4	13.0	.0130	.00174	9.09	.00909	.00122
41	5.0	12.8	.0128	.00171	8.94	.00894	.00120
42	5.5	12.6	.0126	.00168	8.84	.00884	.00118
43	6.1	12.4	.0124	.00166	8.74	.00874	.00117
44	6.6	12.2	.0122	.00163	8.59	.00859	.00115
45	7.2	12.1	.0121	.00162	8.44	.00844	.00113
46	7.7	11.9	.0119	.00159	8.34	.00834	.00111
47	8.3	11.8	.0118	.00158	8.24	.00824	.00110
48	8.9	11.6	.0116	.00155	8.14	.00814	.00109
49	9.4	11.5	.0115	.00154	8.04	.00804	.00107
50	10.0	11.3	.0113	.00151	7.94	.00794	.00106
51	10.5	11.2	.0112	.00150	7.84	.00784	.00105
52	11.1	11.0	.0110	.00147	7.47	.00774	.00103
53	11.7	10.9	.0109	.00146	7.64	.00764	.00102
54	12.2	10.8	.0108	.00144	7.54	.00754	.00101
55	12.8	10.6	.0106	.00142	7.44	.00744	.00099
56	13.3	10.5	.0105	.00140	7.34	.00734	.00098
57	13.9	10.3	.0103	.00138	7.29	.00729	.00097
58	14.4	10.2	.0102	.00136	7.19	.00719	.00096
59	15.0	10.1	.0101	.00135	7.09	.00709	.00095
60	15.5	10.0	.0100	.00134	7.04	.00704	.00094
61	16.1	9.9	.0099	.00132	6.99	.00699	.00093
65	18.3	9.4	.0094	.00126	6.59	.00659	.00088

To adjust for altitude differences, multiply by

$$\frac{B}{760}, \frac{B}{29/92}, \text{ or } \frac{B}{1013},$$

for barometric readings in millimeters, inches or millibars, respectively, at constant temperature. To adjust for salinity effects, multiply by

$$\left(1 - \frac{S(.552)}{100}\right), \text{ S is the symbol for salinity in } \text{‰}.$$

OXYGEN

Under conditions where it is necessary to introduce oxygen by mechanical means to reerate a body of water, the following experiment conducted by R. G. Piper describes some of the current methods of introducing pure oxygen into a body of water containing fish.

Equipment-hatchery hauling tank, pressure oxygen bottles with regulators, stone tubes, micropore tubes and latex tubes, micropore tubes and latex tubes perforated by sewing machine needles.

Fish size - 7 inches

Total fish weight - 450 lbs

Temperature 8 C.

O₂ level of 6 ppm to be maintained

Oxygen flow rates:

1.5 1/min. with stones (2 in. dia., with combined length 18 ft.)

5.0 1/min. with micropore tubes (9/16 in. dia., with combined length 18 in.)

4.0 1/min. with latex tubes (9/16 in. dia., with combined length 18 in.)

Fish use equals .72 1/min. to .9 1/min. as calculated from table by J. Elliott.

The use of the above delivery rates given the following efficiencies of reoxygenation:

Stones	48-60%
Micropore tubes	15-18%
Latex tubes	18-23%

Size and number of released bubbles are important factors in mechanical reoxygenation of water.

Capacity of O₂ cylinder (Linde Oxygen Service):

K cylinder 19 lbs or 244 cu feet or 6910 l

T cylinder 26 lbs or 330 cu feet or 9345 l

Reoxygenation by Mechanical Means,
(R.G. Piper, Telephone communications, 1979).

OXYGEN

References Reviewed

1. Wen, Ching-Gung, Jao-Faun Kao, and Lawrence K. Wang, "Mathematical modeling of stream quality by a new method: theoretical development." *J. Environmental Management*. 10(1):1-12. 1980.
2. Camp, T.R., "Water and its impurities." New York: Reinhold Publishing Co. 1963.
3. Dobbins, W.E., "BOD and oxygen relationships in streams." *J. Sanitation Engineering Division, ASCE* 90, No. SA3, pp. 53-78. June, 1964.
4. Streeter, H.W., "The oxygen sag and dissolved oxygen relationships in streams." In "Oxygen Relationships in Streams," U.S. Department HEW Technical Report, W58-2, pp. 25-28. 1958.
5. Le Bosquet, M., Jr., "Discussion," in "Oxygen Relationships in Streams," HEW Seminar, Technical Report, W58-2, pp. 28-30. 1958.
6. Phelps, E.B., "Stream Sanitation." John Wiley and Sons, Inc., New York, Fourth printing, 276 pp. 1960 edition.
7. Whipple, W., Jr., J.V. Hunter, F.W. Dittman, S.L. Yu, and G.E. Mattingly, "Oxygen regeneration of polluted rivers: the Delaware River." EPA, Water Quality Office, Project #16080 DUP, 86 pp. December, 1970.
8. Whipple, W., Jr., J.V. Hunter, F.W. Dittman, S.L. Yu, B. Davidson, and G. Mattingly, "Oxygen regeneration of polluted rivers: the Passaic River." EPA, Water Quality Office, Project #16080 FYA, 56 pp. March, 1971.
9. Baumgardner, R.K., "Oxygen balance in a stream receiving domestic and oil refinery effluents." Ph.D. thesis, Oklahoma State University, Stillwater, Oklahoma. 70 pp. 1966.
10. Markovsky, Mark, "On the reoxygenation efficiency of diffused air aeration." *Water Reservoirs*. 13(12):1339-1346. 1979.
11. Lanbein, W.B., and W.H. Durum, "The aeration capacity of streams." Geological Survey Circular 542, U.S. Department of the Interior, 6 pp. 1967.
12. Hayes, F.R., I.R. Wilmot, and D.A. Livingstone, "The oxygen consumption of the salmon egg in relation to development and activity." *J. Experimental Zoology*, 116:377-395. 1951.
13. Brett, J.R., "Fish - the energy cost of living." In "Marine Aquiculture," W.J. McNeil, Editor. Oregon State University Press. pp. 37-52. 1970.
14. Brett, J.R., "The respiratory metabolism and swimming performance of young sockeye salmon." Fisheries Research Board of Canada, Biological Station, Nanaimo, B.C. *Journal Fisheries Research Board of Canada*, Vol. 21, No. 5. 1964.
15. MacLeod, John Cameron, and Lloyd L. Smith, Jr., "Effect of pulpwood fiber on oxygen consumption and swimming endurance of the fathead minnow, *Pimephales promelas*." *Transactions of the American Fisheries Society*, 95:71-84. 1966.
16. Webb, P.W., and J.R. Brett, "Effects of sublethal concentrations of sodium pentachlorophenate on growth rate, food conversion efficiency, and swimming performance in underyearling sockeye salmon (*Oncorhynchus nerka*)." *Fisheries Research Board of Canada, Journal*, 30:499-507. 1973.
17. MacLeod, John Cameron, and Lloyd L. Smith, Jr., "Effect of pulpwood fiber on oxygen consumption and swimming endurance of the fathead minnow, *Pimephales promelas*." *Transactions of the American Fisheries Society*, 95:71-84. 1966.

INDEX

INDEX

Note: Page numbers in the Handbook combine the chapter number and page number within the chapter. Thereby, Chapter 7 + page 3 = 7.3.

A

Abbreviations, 1.3, 1.4, 1.5, 11.1
Acid rain, 10.1
Acrolein (Aqualin), 17.2
Adhesive eggs, 5.13, 5.15, 5.21, 5.26, 5.28, 5.29, 5.30, 7.1
Alewife
 life history, 5.29,
 (See other chapters for specifics)
Algae control, 19.2
Algae (filamentous), problems on
 fish screens, 26.2
Algaeides, (See Ch. 16)
Aluminum, toxic effect, 13.1
Ammonia nitrogen, toxic effects, 13.1
Anesthetics and tranquilizer drugs in
 fisheries work, Ch. 22
Antimycin A (Fintrol), 17.1
Aquatic fauna (invertebrate)
 distribution, 8.10, Ex. K
Aquatic insects, abundance, 8.11, Ex. L
Arctic Grayling
 life history, 5.12 - 5.13
 (See other chapters for specifics)
Arsenic, toxic effects, 13.1
Artificial guidance of fish, Ch. 26
 affected by bed load, 26.2
 barrier dams, 26.2, 26.12, Ex. I, J
 by-pass outlets, 26.3
 channel shaping, 26.1
 chemical barriers, 26.1 (See also Ch. 13)
 drum screens, 26.2, Ex. B
 effect of bubble screens, 26.1
 effect of corners, angles, 26.1
 effect of electric screens, 26.1
 effect of pressure changes, 26.1
 effect of temperature, 26.1
 effect of turbidity, 26.1
 effect of water depth, pressure, 26.1
 electric fence diagram, 26.4, Ex. A
 entrance depth recommended at
 facilities, 26.1
 fixed screen cleaning, 26.2
 louver screens, 26.2
 mesh size formula for screening devices,
 26.2
 problems of screening devices, 26.2,
 26.7, Ex. D
 rack bars, 26.1
 screening installations, typical
 configurations, 26.2,
 26.4 - 26.12, Ex. A - J
 stimuli, 26.1
 submerged inclined plane screen, 26.3
 submerged travelling screen (STS), 26.3
 sudden transitions to be avoided, 26.1
 use of light, 26.1, (See also Ch. 24)
 use of screens, 26.1, Ex. A - H
 (See also Ch. 3)
 use of visible curtains (chains or metal
 strips), 26.1
 use of water velocity, 26.1 - 26.2
 visual references, 26.1, (See also Ch. 24)

winter conditions - icing, heating
 required to prevent, 26.2
 wire screens, 26.2, 26.5, Ex. B, 26.6, Ex. C
Artificial spawning channels, Ch. 27
 barrier or lead required, 27.1
 bedload, need for removing, 27.1
 design criteria, 27.1
 early fry emergence, 27.1
 effect of temperature, oxygen pollution,
 27.1
 fish species (chinook, sockeye, pink,
 chum salmon), 27.1
 hydraulic criteria, 27.1
 layout and structures, 27.1, 27.3, Ex. C
 percolation, 27.1
 plan-typical layout, 27.3, Ex. C
 types, upwelling and stream, 27.1,
 27.2, Ex. A, B
Atlantic salmon, 5.1
 distribution, 4.4, Ex. I
 scientific & common names, 4.1,
 (See other chapters for specifics)
Avoidance, Ch. 18
 behavior of downstream migrants, 18.1
 behavior of upstream migrants, 18.1
 chlorine (special effect), 18.1
 effect of chemicals, 18.1
 effect of contaminants, 18.1
 effect of electric shock, 18.1
 effect of nitrogen, 18.1
 effect of noise, 18.1
 effect of oxygen levels, 18.1
 effect of siltation, 18.1
 effect of siltation, 18.1
 effect of sound waves, 18.1
 effect of temperature, 18.1
 effect of turbulence, 18.1
 exposure, constriction, 18.1
 light intensity change, 18.1
 L-Serine, 18.1
 movement, 18.1
 odors, 18.1
 pesticides, herbicides, 18.1
 pressure changes (by salmon and
 trout), 18.1

B

Barium, toxic effect, 13.1
Barrier dams, 26.2, 26.12, Ex. I, J
Bass, Largemouth
 distribution, 4.9, Ex. VI
 illustration, 4.2
 life history, 5.14 - 5.15
 scientific & common names, 4.1
 (See other chapters for specifics)
Bass, Smallmouth
 distribution, 4.9, Ex. VI
 illustration, 4.2
 life history, 5.14 - 5.15
 scientific & common names, 4.1
 (See other chapters for specifics)
Bass, Spotted
 distribution, 4.9, Ex. VI
 scientific & common names, 4.1
Bass, Striped
 distribution, 4.7, Ex. IV
 illustration, 4.2
 life history, 5.14 - 5.15

 scientific & common names, 4.1
 (See other chapters for specifics)
Bass, White
 distribution, 4.8, Ex. V
 life history, 5.14 - 5.15
 scientific & common names, 4.1
 (See other chapters for specifics)
Bayer 73, 17.2
Beaufort Scale (wind velocity), 1.7
Bed load
 definition, 12.1
 effect on alevins, 12.1
 effect on eggs, 12.1
 effect on food organisms, 12.1
 effect on guidance, 12.2
Bluegill
 illustration, 4.2
 life history, 5.16 - 5.17
Boron, toxic effects, 13.2
Bottom organisms, relationship by
 months, temperature flow, 8.14, Ex. P
Brood year-defined, 5.1
Bubble screens, 26.1
Brook trout
 distribution, 4.5, Ex. II
 illustration, 4.2
 life history, 5.10 - 5.11
 scientific & common names, 4.1
 (See other chapters for specifics)
Brown trout
 distribution, 4.5, Ex. II
 illustration, 4.2
 life history, 5.10 - 5.11
 scientific & common names, 4.1
 (See other chapters for specifics.)
Buffalo, bigmouth
 life history, 5.28
Bullhead, brown
 illustration, 4.2
 life history, 5.18-5.19
 scientific & common names, 4.1
 (See other chapters for specifics)
Bullhead, black
 illustration, 4.2
 life history, 5.18-5.19
 scientific & common names, 4.1
 (See other chapters for specifics)
Bullhead, yellow
 illustration, 4.2
 life history, 5.18 - 5.19
 scientific & common names, 4.1
 (See other chapters for specifics)
Bulb turbines, 25.1
By-pass outlets, 26.3

C

Cadmium, toxic effects, 13.2
Carp
 illustration, 4.2
 life history, 5.20 - 5.21
Catfish, channel
 distribution, 4.10, Ex. VII
 illustration, 4.2
 life history, 5.18 - 5.19
 scientific & common names, 4.1
Catfish, white
 distribution, 4.10, Ex. VII
 life history, 5.18 - 5.19

INDEX (Continued)

Catfish, white (Continued)

- scientific & common names, 4.1
- Channel changes, Ch. 32
- Chey's formulae, 32.1
- computation of bed stability, 32.1
- effect of elimination of bends, 32.1
- effect of pools, riffles, 32.1
- loss of spawning, rearing areas, 32.1
- Manning's formula, 32.1
- natural floods, 32.1
- need to maintain stability, 32.1
- possible number of salmonoids per acre affected, 32.1
- principal methods used, 32.1
- R (affecting velocity), 32.1
- relation of stream bed pavement to velocity, 32.1
- resistance of banks, bed pavements, 32.1
- stream roughness coefficient changes, 32.1
- three major purposes, 32.1
- use of rock hurdles or dykes, 32.1
- wetted perimeter calculations, 32.1

Channels, (See Ch. 27, Artificial Spawning Channels)

Char

- distribution, 4.5, Ex. II
- illustration, 4.2
- life history, 5.10 - 5.13
- scientific & common names, 4.1
- (See other chapters for specifics)

Chey's formulae, 32.1

Chinook salmon

- distribution, 4.4, Ex. I
- illustration, 4.2
- life history, 5.2 - 5.3
- scientific & common names, 4.1
- (See other chapters for specifics)

Chiselmouth

- illustration, 4.2
- life history, 5.20 - 5.21

Chlorinated hydrocarbon compounds, 17.2

Chromium, toxic effects, 13.2

Chub, Columbia River (Peamouth)

- illustration, 4.3
- life history, 5.22 - 5.23
- (See other chapters for specifics)

Chub, Roach (Tui)

- life history, 5.22 - 5.23

Chub, Utah

- life history, 5.30

Chum

- distribution, 4.4, Ex. I
- illustration, 4.2
- life history, 5.6 - 5.7
- scientific & common names, 4.1
- (See other chapters for specifics)

Circle areas, pipe sizes, 1.7

Cisco

- distribution, 4.11, Ex. VIII
- life history, 5.30

Coho salmon

- distribution, 4.4, Ex. I
- illustration, 4.2
- life history, 5.4 - 5.5
- scientific & common names, 4.1
- (See other chapters for specifics)

Commercial, game & resident species

- illustrations, 4.2, 4.3

Common names of selected species, 4.1

Common terms, definitions, Ch. 2

Compounds, toxic effects, Ch. 13

Conduits, passage of fish through, Ch. 25

Continental United States,

- biological information on some common species, 5.26 - 5.30

Conversion factors, 1.1

Copper, toxic effects, 13.3

Copper sulfate, algae control, 19.2

Counting stations, 34.2

Crappie, Black

- distribution, 4.9, Ex. VI
- illustration, 4.3
- life history, 5.16 - 5.17
- scientific & common names, 4.1
- (See other chapters for specifics)

Crappie, White

- distribution, 4.9, Ex. VI
- illustration, 4.3
- life history, 5.16 - 5.17
- scientific & common names, 4.1
- (See other chapters for specifics)

Cresol, 17.2

Cubic foot & cubic meter of water - comparison (illustration), 1.6

Culverts, Ch. 31

- design criteria, 31.2, Table 1
- low gradient for small fish, 31.1
- minimum swimming depth, 31.1
- normal design not compatible with fish passage, 31.1
- outlet structures, 31.1
- water velocities favorable for fish passage, 31.2, Table 1

Cutthroat trout (salmon)

- distribution, 4.5, Ex. II
- illustration, 4.2
- life history, 5.10 - 5.11
- scientific & common names, 4.1
- (See other chapters for specifics)

Cyanide, toxic effects, 13.3

D

Dace

- illustration, 4.3
- life history, 5.24 - 5.25

Dams, effects on spawning, 32.1

Dams, uses, nomenclature, 1.5

Definitions, hydraulics, powerhouses, spillways, water, 1.4, 1.5

Definitions of common terms in use, Ch. 2

Delay, 24.2

- effects of temperature, 11.1

- effect of reservoirs, 34.3

Demersal eggs, larvae, 7.1

Detergents, toxic effects, 13.9

Digestion time - trout (at various temperatures), 8.4, Ex. A, 8.9, Ex. I

Diseases, Ch. 21, (See index on chapter title page)

Dissolved gases, (See Ammonia, Nitrogen, Oxygen), Ch. 13

Dolly Varden

- distribution, 4.5, Ex. II
- illustration, 4.2
- life history, 5.10 - 5.11
- scientific & common names, 4.1

Downstream migrants, movement of, (See Ch. 24)

Drugs (use in fisheries work), Ch. 22

- care in use, 22.1
 - effect of sea water, 22.1
 - effect of water temperatures, quality, 22.1
 - effect on humans, 22.1
 - M.S. 222, 22.4, Table 2
 - preferred use, 22.2
 - recovery time, 22.2
 - selected species and M.S. 222, 22.4, Table 2
 - side effects, 22.1
 - test trials necessary, 22.1
 - types, 22.1
 - use in fisheries work, 22.1 - 22.4
 - use in hatcheries, 22.2
 - use in tagging, marking, 22.2
 - use in transportation, 22.1
- ### Drum screens, 26.2, Ex. B
- ### Dye, effect on turbidity, 12.1
- ### Dynamite - weight vs lethal range, 1.10

E

Effects of fishing pressure, Ch. 9

Eel, swimming speeds, 6.3, Ex. A, B

Eggs, effect of temperature changes, 11.1

Eggs (sockeye)

- effect of gravel size, uniformity, 12.6, Fig. 3
- effect of uniform water velocity, 12.5, Fig. 2
- survival dependency on flow of water through gravel bed, 12.4, Fig. 1

Electricity, (See Ch. 26, Ch. 29)

Elements, toxic effects, Ch. 13

Elements, compounds - toxic effects, Ch. 13

Endrin, 17.2

Energy requirements of trout compared with oxygen demands, 8.5, Ex. B

English to Metric, conversion factors, 1.1

Equivalents - English & Metric, 1.1

Equivalents & Terminology, 1.3

Escapement, 8.17, Ex. S

Estuaries

- effect of pesticides, 16.2
- fish rearing areas, 16.2

Euchalon (See Smelt)

F

Farm ponds, 12.2

Federal Court decisions affecting fish rights, 3.1

Feeding, growth rates at various temperatures, 8.6, Ex. E, 8.7, Ex. F, 8.8, Ex. G, H

INDEX (Continued)

- Feeding levels**, 19.10, Ex. C, 19.11, Ex. D
Feeding rate of trout, temperature effect, 8.6, Ex. E
Feeding rates, sizes, temperature, Rainbow trout, 8.4, Ex. A, 19.2, Ex. E
Fish, temperature effects, Ch. 8
Fish diseases, types, causes & remedies, Ch. 21, (See index on chapter title page)
Fish gills (clubbed), effects of silt, 12.2
Fish - illustrations of game, resident species, 4.2, 4.3
Fish ladders, (See Ch. 34)
Fish locks, Ch. 33
Fish protection laws, 3.1
Fish pumps, Ch. 23
air bubble disease, 23.1
juveniles - special pumps required, 23.1
oxygen & nitrogen supersaturation should be avoided, 23.1
runner speed, 23.1
strike (speed), 23.1
Venturi action should be avoided, 23.1
Fish screens, (See Ch. 26)
Fish species, descriptions, Ch. 4, 5, (See other chapters for specifics)
Fish species, Continental United States, Scientific & Common Names, 5.26 - 5.30
Fish species, length-weight relationship for adults, 5.31, Ex. A
Fish species, most common in Western U.S., (See 5.2 - 5.25)
age at maturity,
average number of eggs (range),
classification-sport, commercial,
predaceous, forage, nuisance,
downstream migration times,
egg incubation, occurrence,
preferred temperature, spawning times,
time in fresh water (rearing),
time in ocean, time of adult migration,
and weight (range),
Fish toxicants, Ch. 17
Fish transportation, (See Ch. 30)
Fishing pressure, Ch. 9
Fishway design data, 34.4
Fishway turbine pumps, 34.23, Ex. S
Fishway structures at dams and natural obstructions, Ch. 34
Alaska steep pass fishway, 34.1
auxiliary water, 34.2
auxiliary water for drowned-out pools, 34.2, 34.8, Ex. D
auxiliary water turbine, 34.22, Ex. R
baffle-type, design criteria, 34.11, Ex. G, 34.12, Ex. H, 34.13, Ex. I
baffle-type, vertical slot applications, 34.28, Ex. X, 34.29, Ex. Y, 34.32, Ex. BB
baffle-type, weir, orifice design, 34.1, 34.2
barrier dams, 34.2
bed load effect, 12.1
collection systems at powerhouses, 34.2, 34.26, Ex. V, 34.27, Ex. W
collector systems, 34.2
counting board lighting, 34.2
counting board closure effects, 34.3
counting station location, 34.2, 34.3
counting station - need of large pool below, 34.3
counting stations, systems, 34.2
criteria for design of temporary fishways during construction, 34.3
criteria for structure sizes, location, flows, 34.4
darkened fishways, 34.1
Denil fishway, 34.1, 34.13, Ex. I
depth of adult fish approaching obstructions, 34.2
diffuser arrangement, 34.2, 34.20, Ex. P, 34.21, Ex. Q, 34.26, Ex. V
diversion tunnel or open bypass in lieu of temporary fishway, 34.3
eel passes, 34.1
effect of high dams on fish passage, 34.2
effect of deep reservoirs on fish migration, 34.3
effect of delay in reservoirs, 34.3
effect of light, shadow patterns on fish, 34.1
effect of project operation, 34.3
effect of shallow entrances, 34.2
effect of water temperature, quality (taste, odor), 34.3
entrance position in relation to jump or standing wave, 34.2
exit locations, 34.2
fish jumping prevention, 34.1, 34.33, Ex. CC
fish lock description, 34.3 (See also Ch. 33)
fish passage - nonuniform, 34.2
fish passage structure terms, 34.1
fishway capacity, 34.4
fishway design data, 34.4
fishway entrances, vertical, horizontal positions, 34.2
fishway patterns - choice decided by site condition, 34.1
flow continuity break to be avoided, 34.2
hydraulic instability, 34.1, 34.30, Ex. Z
Ice Harbor design, 34.9, Ex. F
laws, Ch. 3
low dams (retrofitted), 34.3, 34.36, Ex. FF
models for project conditions, 34.3
nitrogen entrainment at spillways, 34.3
orifice design discussed, 34.1
orifices with lighted backgrounds preferable, 34.2
pool & weir fishway, 34.1, 34.11, Ex. G
plunging flow, 34.9, Ex. F
prevention of fish drop backs, 34.2
shad passage requirements, 34.1
shooting flow, 34.9, Ex. E
shore-located entrances, 34.2
site importance, 34.1
special control weirs described: 34.1
finger trap, 34.15, Ex. K
jump-over weir, 34.16, Ex. L
V trap, 34.1
weir crest, 34.15, Ex. K
square corners to be avoided, 34.1
streaming flow, 34.9, Ex. E
sturgeon passage requirements, 34.1
temporary construction, 34.3
temporary trapping, hauling of fish during construction, 34.3
transportation flows, 34.2
trash rack dimensions, 34.1
use of darkened fishways, 34.1
use of special pool regulating devices, orifice control, special weir control, 34.1
vertical slot fishways, 34.1, 34.2, 34.12, Ex. H
vertical slot fishways - discharge formula, graph, 34.14, Ex. J
weir, orifice flexibility limited, 34.1
weirs for hydraulic stability, 34.1
Flood flows, effect, 34.2
Fluoride, toxic effects, 13.3
Food and energy requirements, 8.2
Food - trout occurrence in streams, 8.9, Ex. J
Food (live minnows, meats), 8.5, Ex. D
Brook trout - digestion rate at different temperatures, 8.6, Ex. E
Food consumption (at temperatures, fish sizes), 8.8, Ex. H
Food conversion, natural and diet (salmon), 8.5, Ex. C
Food producing areas, Ch. 8
altitude & fish production, 8.1
dissolved oxygen, 8.1, 8.2
effect of flood flows, 8.2
effect of gradient, 8.2
effect of silt, 8.2
effect of temperature, 8.2
energy control in streams, 8.2
fish (specialized feeders), 8.1
hydrogen sulfide, 8.1
hard water (production high), 8.1
lakes - age important, 8.1
lakes - characteristics, 8.1
lakes - measurement of food potential, 8.1
latitude & fish production, 8.1
light-level for salmonoid feeding, 8.1
pools & riffles, 8.2
predators, 8.1
slope data (sources), 8.3
soft water (production low), 8.1
streams - characteristics, 8.1
streams - measurement of food potential, 8.1
sun factor & fish production, 8.1
velocities, 8.2
yearling per square yard, 8.2
Food requirements for fish, 8.5, Ex. D, 8.11, Ex. L, 8.12, Ex. N, 8.13, Ex. O
Food, energy requirements as affected by temperature, 8.2
Food organisms, 8.2
Food - type, quantity ingested (trout), 8.13, Ex. O
Foods (fish), caloric contents, 19.3, 19.13, Ex. H
Formulas, hydraulic (basic), 1.6
Francis turbines, 25.1
Free fall, Ch. 25
Fyke nets, 29.1, 29.4, Ex. B

G

Game fish, (See Fish Species)
Gasses, toxic effects, Ch. 13

INDEX (Continued)

Golden Redhorse

life history, 5.30

Golden trout (salmon)

distribution, 4.5, Ex. II

illustration, 4.2

life history, 5.10 - 5.11

scientific & common names, 4.1

Grayling, Arctic (See Arctic Grayling)

Growth - effect of temperature, 11.1

Guidance, (See Ch. 26)

H

Hatcheries, Ch. 19

benefits, 19.1

cabinets, 19.3

cold storage, 19.4

control of algae, 19.2

copper sulfate, 19.2

creosote - avoid, 19.1

deep matrix boxes, 19.3

design layout, 19.3

disease control, 19.2, 19.3, 19.4

(See also Ch. 21)

effect of high, low temperature

on eggs, 19.1

effect of light, 19.4

effect of temperature on food

assimilation, 19.5

egg loss elimination, 19.1

eggs, fry must be protected from

direct sunlight, 19.4

eggs, tender stages, 19.3

eggs, transfer, 19.4

employees, housing, 19.4

feeding levels, 19.10, Ex. C, 19.11, Ex. D,

19.12, Ex. E

fire protection, 19.4

fish catch - escapement ratio, 19.1

fish diseases, (See index on Ch. 21

title page)

fish egg-numbers in traps, baskets, 19.3

fish size for ponds, 19.9, Ex. B

food, caloric content, 19.13, Ex. H

food conversion, 19.12, Ex. E,

19.13, Ex. F, G, H

food for fish, 19.10, Ex. C,

19.11-13, Ex. D-H

food (fish) storage, 19.3

fungus-inhibiting chemicals, 19.2

incubation temperature, 19.1, 19.3

incubator trays, 19.3

IHNV, 19.3, 19.4

labor-saving devices, 19.4

laws, (See Ch. 3)

marking, tagging fish, 19.4, 19.5

metabolic rate, 19.5, 19.12, Ex. E,

19.13, Ex. F, G

net pens (See Net pens)

NORAD incubator, 19.3

once-flow-through hatchery, 19.1

overcrowding avoidance, 19.2

oxygen, 19.3

oxygen effect on food consumption, 19.5

pit tags, 19.5

pH control, 19.5

pond design, capacity, 19.2, 19.3

pond loadings, 19.9, Ex. B

pumping costs, 19.15, Ex. J

salmon species best adapted, 19.1

site selection, 19.1, 19.2

tags, 19.5

tattooing, 19.5

temperature for incubation, 19.1, 19.3

trout species best adapted, 19.1

use of anesthetics, (See Ch. 22)

use of ultraviolet light, 19.2

warm water fish, 19.1

waste disposal, 19.4

water control, distribution, 19.4

water criteria, requirements, 19.1

water pollution, 19.4

water purification, 19.4

water quality, (See Ch. 10)

water recirculation system, 19.2

water supply, 19.4

water temperature (optimum), 19.1

Hatching time

salmon, 5.1, 19.7, Tables 1, 2

trout, 5.1

Hauling, mechanical, Ch. 30

Herbicides, Ch. 16, (See also Pesticides)

concentrations, 16.2

effect of aromatic solvents, 16.2

effect of 2,4-D, 16.2

effect on fish, 16.2

effect on rainbow trout, 16.2

inorganic, 16.2

organic, 16.2

synergistic effects, 16.2

toxic effects, 16.2

Humidity tables, 1.9

Hydraulics, definitions, Ch. 1

Hydrogen ion, (See pH)

Hydrogen sulfide, toxic effects, 13.4

I

Ice Harbor fishway, 34.10, Ex. F

Iron, toxic effects, 13.4

Isobornyl thiocyanacetate, 17.3

J

Jacks, defined, 5.1

Jackson turbidity unit, 12.1

K

Kaplan turbines, 25.1

Kokanee (landlocked sockeye)

distribution, 4.4, Ex. I

illustration, 4.2

life history, 5.6 - 5.7

L

Lake trout

distribution, 4.5, Ex. II

illustration, 4.2

life history, 5.12 - 5.13

scientific & common names, 4.1

Lakes, (See Ch. 8)

hydrogen ion (pH) level, 8.1

rehabilitation, 8.1

rehabilitation stocking rates, 8.1

Lamprey (adult, swimming speeds), 6.3

Larvae sizes, 5.26 - 5.30

Laws, (See Ch. 3)

Lead, toxic effects, 13.4

Legal, Ch. 3

Light, 18.1, 24.1, 24.6

Locks & mechanical handling, Ch. 33

attraction, holding fish, necessary, 33.1

bottom diffusing area - most effective

method of introducing attraction

water, 33.1

current pattern of removing fish from

lock required, 33.1

fish lock cycle described, 33.1

idealized fish lift, 33.1

idealized lock system, 33.1

lifts - not fully automated, 33.1

light - investigated but not proved of aid

in decreasing passage time, 33.1

locks - bucket design similar to holding

tank, 33.1

locks - fish lifted by buckets, 33.1

locks - surface area between 300 - 400

square feet, 33.1

mechanical sweep to clear lock

chamber, 33.1

method of fish discharge from lifting

bucket, 33.1

necessity of quick attraction of fish into

lock chamber, 33.1

operation of fish lock similar to operation

of navigation lock, 33.1

position of fish in locks, 80% between

depths of 3 - 6 feet, 33.1

pressure type lock, 33.1

retention of fish in locks, 33.1

round locks preferable to

rectangular, 33.1

surface type lock, 33.1

underwater ports - for fish that refuse

to surface or jump, 33.1

water velocity requirement in locks, 33.1

Longnose Gar

life history, 5.26

Louver screens, 26.2

M

Malachite green, concentration for

fungus prevention, 21.11

Manganese, toxic effects, 13.5

Mechanical handling, Ch. 33

Mechanical hauling of fish, Ch. 30

Mercury, toxic effects, 13.5

Metabolic rate (in hauling), 30.1

Metals, Ch. 14, (See also Ch. 15)

bronze in pump propellers, etc,

harmful, 14.1

copper in piping harmful, 14.1

fish adaptation, 14.1

heavy ions may cause death, 14.1

heavy ions may inhibit plant life, 14.1

hydrogen ions, (See pH)

levels recommended, (See Ch. 13)

phenol for wooden pipes harmful, 14.1

stainless steel (low numbers)

harmful, 14.1

INDEX (Continued)

Metals (Continued)

- toxic effects, 14.1
- trace amounts in waters, 14.1
- use in paints, 14.1
- zinc-coated pipes harmful, 14.1
- Methanethiol**, toxic effects, 13.5
- Methyl ethyl ketone**, toxic effects, 13.5
- Metric to English**, conversion factors, 1.1
- Migrants, Movement of Downstream**, (See Ch. 24)
- Minnow, Silvery**
 - life history, 5.27
- Minnnows, fathead**, effect of carbamate Sevin, 16.1
- Miscellaneous Information**, Ch. 1
- Movement of Downstream Migrants**, (See Ch. 24)
 - delay effects, 24.2
 - diel fluctuation, 24.1
 - effect of lights, 24.1
 - effect of stream flow, 24.1
 - estuaries, 24.2
 - factors, influencing, 24.1
 - mortality causes, 24.1, 24.2
 - path distribution factors, 24.1
 - periods, 24.1 (See also Ch. 8)
 - rate of travel, 24.1
 - residualism, 24.2
 - size, 24.1
 - temperature, effect of, 24.1
 - velocity of river, 24.1
- Muskellunge**
 - life history, 5.29
- Mullet**
 - distribution, 4.11, Ex. IX

N

Net pens

- bottom fouling, 19.6
- cold water species, 19.5
- disease, 19.6
- growth rates, 19.6
- marine net pen complex - typical structure, 19.5
- marine net pen - size, 19.6
- maximum density area relationship (State of Washington), 19.6
- salt water density & fish food, 19.6
- siting considerations, 19.6
- species propagated - (Pacific & Atlantic salmon, steelhead, rainbow, bass, tuna, telapia & carp), 19.5
- tidal currents, 19.6
- typical production station, 19.5
- warm water species, 19.5
- water interchange necessary, 19.6
- Nitrate**, toxic effects, 13.6
- Nitrogen**, toxic effects, 13.6
- Nitrogen, water temperature**, Nomogram, 1.12
- Nitrogen compound (TFM)**, 17.3
- Nitrosalicylanilide (synergist) (DCN)**, 17.13
- Nomograms**
 - nitrogen, water temperature, 1.12

- oxygen solubility in water, 1.11
- oxygen saturation in water, 1.12

O

- Oil spills**, 10.1
- Organophosphates**, 17.2
- Oxygen**, Ch. 35
 - absorption coefficient for pond reaeration, 35.3
 - adult requirements, 35.4, Table 2
 - affected by turbidity, 12.2
 - air-gas, composition of, 35.1
 - altitude differences - formula to adjust for effects on oxygen saturation, 35.5, Table 4
 - concentration under various temperatures, in fresh water, 35.5, Table 4, Nomographs, 1.11, 1.12
 - consumption, (See use diffusion coefficient for pond reaeration), 35.3
 - mechanical methods of reaeration, (stones, micropore, latex tubes), 35.6
 - oxygen cylinder capacity (K cylinder, T cylinder), 35.6
 - oxygen, growth, 8.2, 8.5, Ex. B
 - oxygen, growth - salmonoids, 9.11, Ex. D
 - oxygen sag curve, 35.1
 - oxygen saturation, Nomogram, 1.12
 - oxygen solubility, Nomograph, 1.11
 - oxygen - spawning criteria, Ch. 7
 - oxygen - swimming speeds, Ch. 6
 - oxygen - temperature, Ch. 11
 - oxygen use by adult fish from resting to feeding, 35.4, Table 3
 - oxygen used by fed, starved fish, 35.3, Table 1
 - oxygen use by migrating smolts, adults, 35.4, Table 2
 - pond reaeration, 35.3
 - reaeration coefficient for ponds, 35.3
 - reoxygenation coefficient for stream reaeration, 35.1
 - salinity - formula to adjust for effects on oxygen saturation, 35.5, (Table 4)
 - stream reaeration, 35.1

P

Paddlefish

- life history, 5.26
- pH**, 8.1, 10.1, 19.2
- Passage of fish through turbines**, spillways and conduits, Ch. 25
 - cavitation, 25.1
 - effect of deceleration, 25.1
 - effect of pressure changes, 25.1, 25.3, I
 - effect of snock waves, 25.1
 - effect of spillways, 25.1
 - effect of temperature, 25.1
 - effect of temperature on swim bladder, 25.1
 - embolism, 25.1
 - flow nets, 25.1, Ex. A
 - free fall, 25.1
 - negative pressure, 25.1

- positive pressure, 25.1
- pressure changes, 25.1
- Perch, Sacramento**
 - distribution, 4.9, Ex. VI
 - illustration, 4.3
 - life history, 5.16 - 5.17
 - scientific & common names, 4.1
 - (See other chapters for specifics)
- Perch, Yellow**
 - distribution, 4.9, Ex. VI
 - illustration, 4.3
 - life history, 5.20 - 5.21
 - scientific & common names, 4.1
 - (See other chapters for specifics)
- Pesticides and Herbicides**, Ch. 16
 - effect of adjuvants, 16.1
 - effect of carbamate group, 16.1
 - effect of chlorinated hydrocarbons, 16.1
 - effect of DDT, 16.1
 - effect of organic phosphates, 16.1
 - effect of solvents, dilutents, 16.1
 - effect of synergists, 16.1
 - effect on estuarine areas, 16.2
 - effect on shellfish, 16.2
 - harmful effects, 16.1
 - recommended control, 16.2
 - Sevin, 16.1
 - toxic buildup, 16.1
- Phenol**, toxic effects, 13.7
- Phenolic compounds**, toxic effects, 13.7
- Phosphates**, toxic effects, 13.7
- Pike, Northern**
 - life history, 5.29
- Pink salmon**
 - distribution, 4.4, Ex. I
 - illustration, 4.2
 - life history, 5.4 - 5.5
 - scientific & common names, 4.1
 - (See other chapters for specifics)
- Pipe sizes**, circle areas, 1.7
- Plastic coatings**, (See Ch. 14)
- Plastics**, Ch. 15
 - ABS resins toxic, 15.1
 - dyes, pigments, fillers or stabilizers, 15.1
 - epoxy cement harmful, 15.1
 - fiberglass (limited testing) nontoxic, 15.1
 - high strength plastic pipe (not toxic), 15.1
 - neoprene (aged) inner tubes toxic, 15.1
 - neoprene (aged) sheeting toxic, 15.1
 - phenoxy resins acceptable, 15.1
 - polyethylene sheeting generally nontoxic, 15.1
 - polyethylene surgical tubing, possible toxic reaction in man, 15.1
 - polymers (pure) generally nontoxic, 15.1
 - poly-propylene rope (limited testing) nontoxic, 15.1
 - polyvinyl-chloride piping doubtful, 15.1
 - polyvinyl-chloride rigid extrusions usually nontoxic, 15.1
 - polyvinyl-chloride sheeting generally toxic, 15.1
 - possible harmful effects, 15.1
 - Saran piping (limited testing) nontoxic, 15.1
 - Teflon sheeting (limited testing) nontoxic, 15.1
 - toxic effects vary, 15.1
- Plunging flow**, 34.9, Ex. E

INDEX (Continued)

- Pond loading formula for**
length, weight relationships, 20.1
- Pond loadings**, 19.9, Ex. B, 20.1
- Ponds**, Ch. 20, (See also Ch. 29)
stocking rate for hatchery fish,
trout brood stock, 19.9, Ex. B
- Ponds, holding**, 19.4
- Potassium, toxic effects**, 13.7
- Predation**, Ch. 28
aquatic mammal predators, 28.1
beneficial effect of turbidity, 28.1
bird predators, 28.1
cannibalism in largemouth bass, 28.1
cannibalism in salmonoids, 28.1
cannibalism in trout, 28.1
control by changing water levels, 28.1
control measures, 28.1
effect of by-passes, 28.1
effect of fish size, 28.1
effect of fish survival, 28.1
forage fish ratio introduction, 28.1
occurrence in same species, 28.1
occurrence with salmon, steelhead
trout, 28.1
sea lamprey in Great Lakes, 28.1
sea lions, 28.1
squawfish control, 28.1
temperature as means of separation of
species, 28.1
- Pressure rates**, (See Ch. 25)
- Pressure changes as a guidance
mechanism**, 26.1
- Pressures, negative**, 25.1
- Production, salmon and trout
in selected Washington streams**,
8.17, Ex. S
- Pulp mill effluents, toxic effects**, 13.9
- Pump vane clearance**, 25.1
- Pumpkinseed**
illustration, 4.3
life history, 5.16 - 5.17
- Pumps**, (See Ch. 23)
- Q**
- R**
- Radioactive materials - toxic
effects**, 13.7
- Rainbow trout (salmon)**
distribution, 4.4, Ex. I
illustration, 4.2
life history, 5.8 - 5.9
scientific & common names, 4.1
(See other chapters for specifics)
- Ranch ponds**, 12.2
- Rearing ponds**, Ch. 20
BOD, 20.1, 10.7, Ex. B
cleaning, handling, effects,
methods of, 20.1, 20.4, Table 5
closed circuit, 20.1
construction & care, 20.1, 20.7, Ex. B
design, 20.1, 20.6, Ex. A
drainage systems, 20.1
feeding tanks, 20.1
fish protection, 20.1, 20.4
metabolic rates of fish, 20.1, 20.3,
Table 2, 20.4, Table 5, 20.5, Table 6
- odor, 20.1
oxygen demand of fish, 20.1,
20.3, Table 2, 20.4, Table 5,
20.5, Table 6
pond loading, 20.1, 20.4, Table 4
types, 20.1, 20.2, Table 1, 20.6, Ex. A,
20.7, Ex. B
water supply, quality, 20.1, 20.7, Ex. B
- Recovery gear**, Ch. 20
beach seines, use, operation, 29.1
electric fish collectors, 29.2
fish wheels, 20.2, 29.3, Ex. A
floating trap net, 29.3, Ex. A
fyke nets (limitations, problems), 29.1,
29.4, Ex. B
gill nets, size, use, 29.1
inclined-plan screen trap, 29.4, Ex. B
photo aids, 29.2
plankton nets, 29.1
traps & pound nets, 29.1
weirs, 29.1
- Redd types and sizes**, 7.6, Ex. C
- Reservoirs**
effect on fish migration, 34.3
removal of sediment from, 12.1
temperature (or oxygen level effect
on cold water fish), 34.3
- Residualism**, 24.2
- Roach (Tui Chub)**
illustration, 4.3
- Rotenone**, 17.1
- S**
- Salmon**
adults, average length/weight,
5.31, Ex. A
distribution, 4.4, Ex. I
illustration, 4.2
life history, 5.2 - 5.7
scientific & common names, 4.1
(See other chapters for specifics)
- Sand filters**, 19.2
- Sauger**
distribution, 4.11, Ex. VIII
- Scientific & common names of some
of the more abundant fish species**,
Ch. 4
- Scientific names of selected species**, 4.1
- Secchi disc reading**, 12.1
- Sedimentation**, (See Silt & Turbidity,
Ch. 12)
- Selenium - toxic effects**, 13.8
- Shad, American**
distribution, 4.6, Ex. III
illustration, 4.3
life history, 5.14 - 5.15
(See use of fishways, 34.1)
- Shad, Gizzard**
distribution, 4.6, Ex. III
life history, 5.26
- Shiner, Bridle**
life history, 5.27
- Shiner, Redside**
illustration, 4.3
life history, 5.24 - 5.25
- Shiner, Spotted**
life history, 5.27
- Shooting flow**, 34.9, Ex. E
- Silt and Turbidity**, Ch. 12
causes, 12.1
composition of silt, 12.1
effect on egg survival, 12.2
effect on redds, 12.2
effect of sedimentation on spawning, 12.2
gill irritation caused by turbidity, 12.2
hatchery operations - adversely affected,
12.2
Jackson Turbidity Unit, 12.1
lake production & turbidity levels,
comparison, 12.1
N.T.V., 12.1
Secchi disc reading, 12.1
sediment causes, 12.1
sediment concentration in rivers
(California, Oregon, Washington), 12.2
sediment - removal from reservoirs, 12.1
sediment - types, 12.1
sedimentation rates & characteristics,
12.1
species - variation in ability to tolerate,
12.1
turbidity - methods of measuring, 12.1
- Silver, toxic effects**, 13.8
- Smelt (eulachon)**
illustration, 4.3
life history, 5.14 - 5.15
- Smelt, Rainbow**
illustration, 4.3
life history, 5.27
- Sockeye**
distribution, 4.4, Ex. I
illustration, 4.2
life history, 5.6 - 5.7
scientific & common names, 4.1
(See other chapters for specifics)
- Sodium - toxic effects**, 13.8
- Sodium cyanide**, 17.2
- Solubility of Oxygen, Nomograph**, 1.11
- Sound, effect on fish**, 18.1
- Spawning channels (artificial)**, Ch. 27
- Spawning criteria**, Ch. 7, (See also Fish
Species, Useful Factors, Ch. 5)
effect of silt, (See Ch. 12)
eggs (adhesive, demersal), 7.1
eggs, number per square foot spawning
bed, 7.2
eggs, sensitive during tender stage, 7.2
energy requirements, (See Ch. 6)
fish energy utilization table, 7.2, Table 2
nest builders, 7.1
oxygen requirement for egg
development, 7.1
redd sizes, salmon, trout, 7.1, Table 1,
(See also Ch. 27)
redds, false (Pink salmon), 7.2
redds, size, 7.1
release of stored water, 7.3
salmon, trout, 7.1
salmon, trout - depth of stream, 7.1
stranding, 7.3
spawning habits (nest builders,
demersal, adhesive eggs), 7.1
stream bed depth (method of
measurement), 7.3
stream bed width (method of
measurement), 7.3